

EUROFER®

LAVORAZIONE DEL FERRO BATTUTO & ACCIAIO INOX
WROUGHT IRON & STAINLESS STEEL WORKING

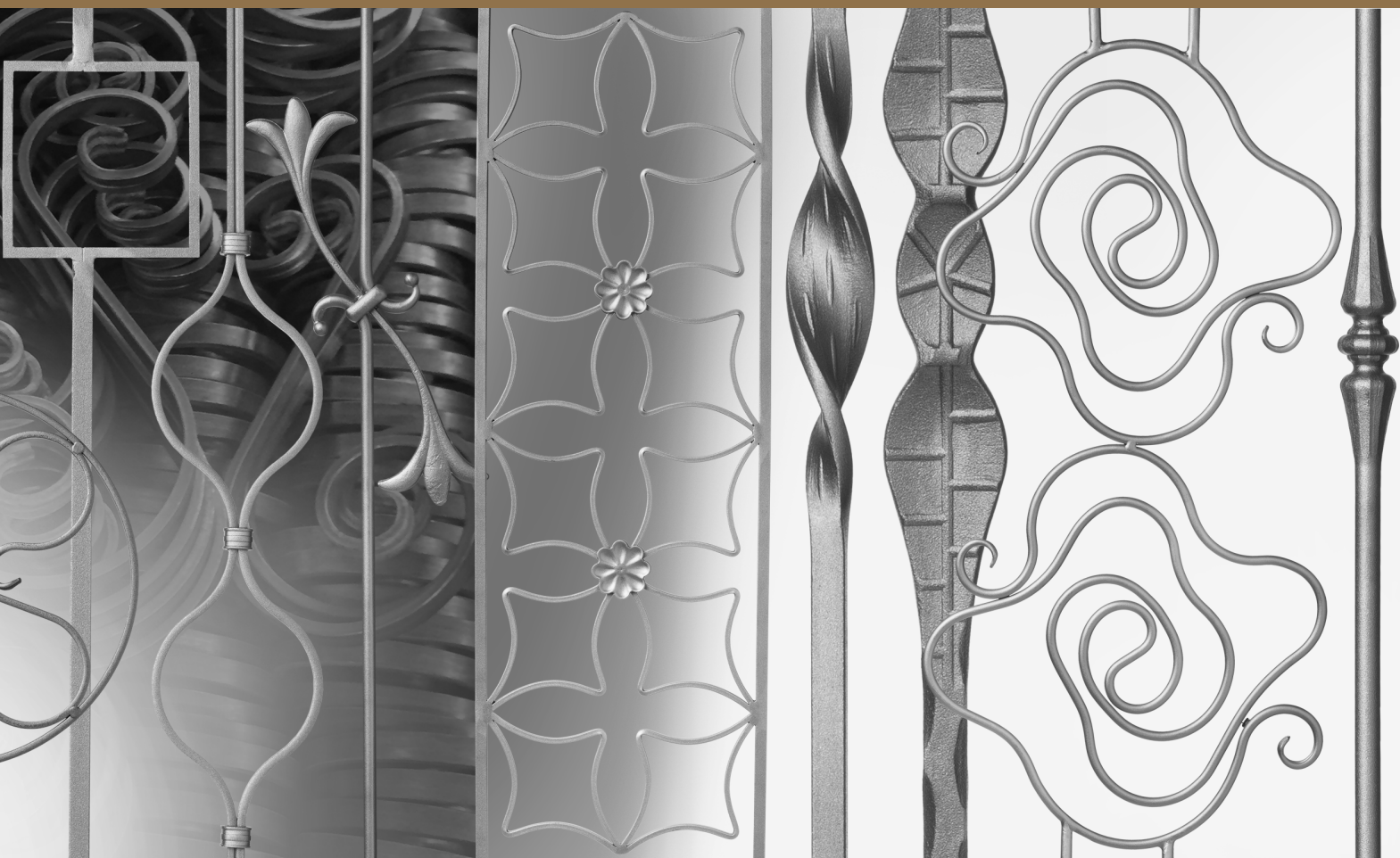

Catalogo
2024
2025

dal 1967

OFFO

LA PRODUZIONE COMPLETA
THE WHOLE PRODUCTION





**LA PRODUZIONE COMPLETA
DI ELEMENTI IN FERRO BATTUTO**

**THE WHOLE PRODUCTION
OF WROUGHT IRON COMPONENTS**

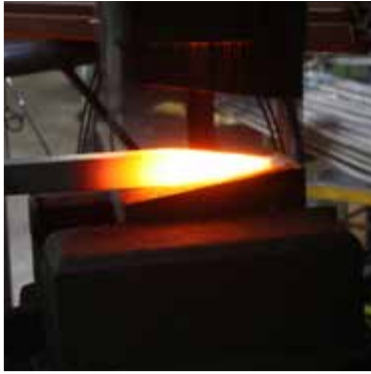
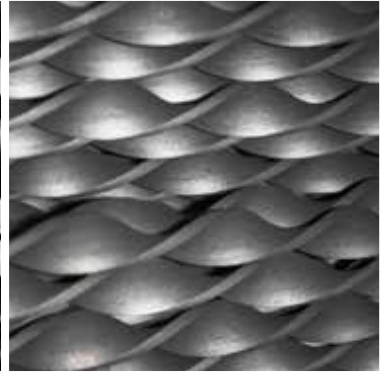
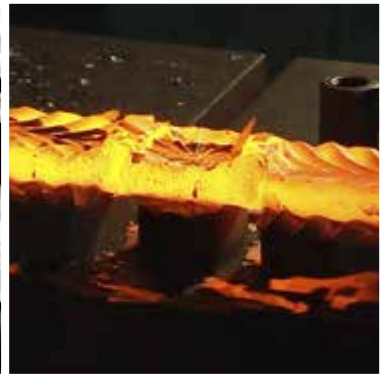
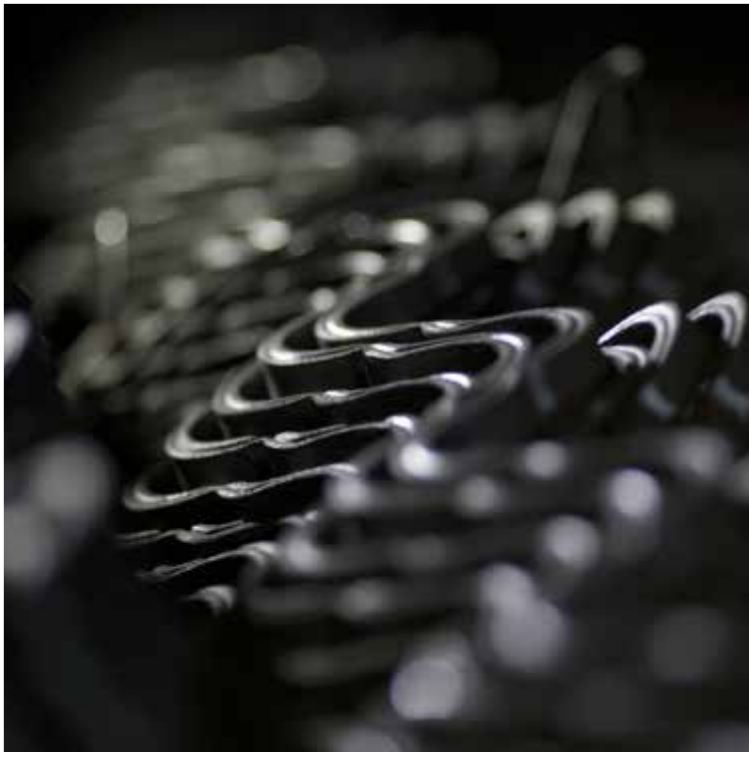
**LA PRODUCTION COMPLÈTE
D'ÉLÉMENTS EN FER FORGÉ**



INDICE / INDEX / INDEX

	CONDIZIONI DI VENDITA / <i>GENERAL CONDITIONS</i>	PAG	4
	LEGENDA / <i>LEGENDA</i>		5
	TERMINALI / <i>ENDS / FINITIONS</i>		6
01	RICCI <i>SCROLLS / VOLUTES</i>		7
02	CERCHI, OVALI E PIGNE <i>CIRCLES, OVALS AND BASKETS / CERCLES, OVALES ET PIGNES TORSADÉES</i>		34
03	ROSONI E QUADRILOBI <i>ROSETTES AND CLIP-ON-UNITS / ROSACES ET ELEMENTS DÉCORATIFS</i>		42
04	BARRE SAGOMATE - LINEA LIBERTY <i>SHAPED BARS - LIBERTY LINE / BARREAUX GALBÉS - PANNEAUX DÉCO</i>		60
05	PANNELLI LISCI E PALETTI PER RECINZIONI <i>PLAIN PANEL UNITS AND STAKES FOR FENCES BARREAUX DE BALCON ET DE CLÔTURE</i>		75
06	PANNELLI MARTELLATI <i>HAMMERED PANELS / PANNEAUX MARTELÉS</i>		115
07	PANNELLI LIQUIRIZIA - PANNELLI RIGATI <i>LIQUORICE PANELS - FLUTED PANELS PANNEAUX RÉGLISSE ET RAYÉS</i>		120
08	BARRE FORATE <i>HOLED BARS / BARRES À TROUS</i>		124
09	TENDENZE ODIERNE <i>MODERN DESIGNS / BARREAUX DÉCORATIFS</i>		142
10	ELEMENTI IN FERRO RICALCATO <i>NEW FORGED BARS / ÉLÉMENTS MODERNES</i>		162
11	ELEMENTI IN FERRO FORGIATO, CAPISALDI E FORGIATI ITALIANI <i>FORGED BARS, POSTS AND  FORGED BARS PANNEAUX FORGÉS, POTEAUX ET FER FORGÉ </i>		170
12	CORRIMANO E PARTENZE <i>HANDRAILS AND CORNERS / MAIN COURANTES, CROSSES DE DÉPART</i>		188
13	BORCHIE, LANCE E PIASTRE <i>STUDS, SPEARS AND PLATES / FERS DE LANCE, BAGUES, PLATINES ACIER</i>		208
14	FIORI E FOGLIE <i>FLOWERS AND LEAVES / FLEURS ET FEUILLES</i>		226
15	CIMASE, TERMINALI ED ELEMENTI VARI <i>ORNAMENTS FOR CARRIAGE GATES AND VARIOUS ELEMENTS ELEMENTS POUR PORTAILS, CLÉS DE TIRANTS ET DIVERS ÉLÉMENTS</i>		235
16	COMPONENTI VARI PER ARREDAMENTO <i>VARIOUS DECOR ELEMENTS / POIGNÉES ET DIVERS ÉLÉMENTS DE DÉCORATION</i>		252
CI	COMPONENTI IN GHISA <i>ELEMENTS IN CAST IRON / FONTE</i>		264
ZF	ARTICOLI ZINCATI A FREDDO <i>COLD GALVANIZED ARTICLES / ÉLÉMENTS GALVANISÉS</i>		265
	Riassunto barre forate in ordine di codice <i>Summary holed bars in order of code / Barre à trous par ordre de référence</i>		270
S	SECRETA - FENCING SYSTEM		276
L	LASERFER		278

CONDIZIONI GENERALI / GENERAL CONDITIONS

1. Offerte e Ordini

1.1 I tempi di consegna riportati nelle Offerte e nelle Conferme d'Ordine sono puramente indicativi e quindi non vincolanti.

1.2 In nessun caso Euro-Fer Spa potrà essere chiamata a risponderne dei danni direttamente o indirettamente causati dalla ritardata esecuzione di un contratto o dalla ritardata consegna dei prodotti.

1.3 Gli ordini e/o le modifiche di ordini effettuate verbalmente devono essere confermati per iscritto da parte dell'acquirente. In caso contrario Euro-Fer Spa non si assume alcuna responsabilità con riguardo a eventuali errori o possibili fraintendimenti.

1.4 Euro-Fer Spa si riserva la possibilità di frazionare un ordine in più spedizioni.

1.5 I prezzi non sono comprensivi di IVA.

2. Restituzione merci

2.1 Euro-Fer Spa non è obbligata ad accettare resi dei prodotti, salvo che sia stato espressamente pattuito per iscritto. Qualsiasi costo a tal fine è sostenuto dall'Acquirente.

2.2 In tutti i casi Euro-Fer Spa non accetta resi di materiale manomesso o modificato rispetto alla fornitura iniziale.

3. Reclami

3.1 Al momento della presa in consegna dei prodotti l'Acquirente dovrà immediatamente verificare la quantità, l'imballaggio e la conformità, e registrare qualsiasi obiezione nella nota di consegna.

3.2 Ogni denuncia per vizi, dovrà essere effettuata tramite comunicazione scritta entro 8 giorni dall'arrivo della merce.

3.3 La comunicazione di cui al 3.2 dovrà chiaramente identificare la fornitura originale e specificare tipologia e ammontare dei vizi addotti.

4. Varie

4.1 Le misure e le fotografie espresse nel catalogo sono indicative, pertanto i prodotti venduti possono differire leggermente.

4.2 Euro-Fer Spa non accetterà reclami per inconvenienti o anomalie dovuti a applicazioni post-vendita non corrette o non adeguate al prodotto. Trattamenti quali verniciatura, zincatura elettrolitica, zincatura a caldo, sabbiatura, o altri, realizzati dopo la vendita, saranno eseguiti sollevando Euro-fer Spa da qualsiasi responsabilità.

4.3 La riproduzione, anche parziale, del presente catalogo è vietata. Tutti i diritti sono riservati da Euro-Fer Spa.

4.4 I documenti, disegni, dati ed informazioni che dovessero venire consegnati al Cliente, rimangono di esclusiva proprietà di Euro-Fer Spa. Il Cliente si impegna a non riprodurli, a non divulgarli a terzi e ad assumere altresì le opportune cautele nei confronti del proprio personale al fine di garantirne la tutela.

4.5 La gamma di Euro-Fer Spa è composta da articoli di differenti materiali: ferro, acciaio, ottone, ghisa, plastica, cristallo, vetro, etc, ciascuno con le proprie caratteristiche e adatto a particolari utilizzi. E' esclusiva responsabilità del Cliente scegliere i prodotti più indicati alle proprie esigenze ornamentali e di utilizzo.

1. Offers and Orders

1.1 *The delivery terms specified in the Offer and in the Order Confirmation are purely indicative and not binding.*

1.2 *In no case will Euro-Fer Spa be liable for damages directly or indirectly caused by the delayed execution of a contract or the delayed delivery of the products.*

1.3 *Purchase orders and / or changes to purchase orders made verbally must be confirmed in writing by the Buyer. Otherwise, Euro-Fer Spa assumes no responsibility for any errors or misunderstandings.*

1.4 *Euro-Fer Spa reserves the right to split a purchase order in several consignments.*

1.5 *Prices do not include VAT.*

2. Return policy

2.1 *Euro-Fer Spa is not obliged to accept returns of products, unless expressly agreed in writing. Any cost arising from the return shall be borne by the Buyer.*

2.2 *In all cases Euro-Fer Spa does not accept returns of material tampered with or modified with respect to what was initially supplied.*

3. Claims

3.1 *Upon receipt of the products, the Buyer shall immediately check the quantity, packaging and conformity, and record any objections in the delivery note.*

3.2 *Any complaint for defects must be made by written communication within 8 days of receipt of the goods.*

3.3 *The written communication relating to paragraph 3.2 must clearly identify the original supply and specify the type and number of defects alleged.*

4. Others

4.1 *Sizes and pictures shown in the catalogues are indicative, therefore the products may differ slightly.*

4.2 *Euro-Fer Spa will not accept claims for inconveniences or anomalies due to incorrect or inappropriate after-sales applications of its products. Treatments such as painting, electrolytic zinc-plating, hot dip galvanizing, sandblasting, or others, made after the sale, will be carried out by relieving Euro-fer Spa from any responsibility.*

4.3 *The reproduction, even partial, of this catalogue is strictly forbidden. All rights are reserved by Euro-Fer Spa.*

4.4 *The documents, drawings, data and information provided from Euro-fer Spa to the Buyer, remain exclusive property of Euro-Fer Spa. The Buyer undertakes not to reproduce them, not to disclose them to third parties and at the same time to take the appropriate precautions toward their staff in order to guarantee its protection.*

4.5 *Euro-Fer Spa range consists of items made of different materials: iron, steel, brass, cast iron, plastic, crystal, glass, etc., each with its own characteristics and suitable for specific uses. It is sole responsibility of the Buyer to choose the most suitable products for its ornamental and use needs.*

LEGENDA / LEGENDA

Le misure sono espresse in millimetri. La lettera "H" sta per altezza e "L" per larghezza, mentre le sezioni sono indicate con i simboli: $\neq \emptyset$ □ (piatto, tondo o diametro, quadro). Tra le dimensioni indicate e quelle reali vi possono essere delle lievi differenze, proprio perchè ogni elemento è prodotto in gran parte a mano.

(ca.) - Per le caratteristiche particolari del ferro forgiato, le misure degli articoli che seguono possono subire delle lievi variazioni dovute al tipo di lavorazioni cui sono sottoposti.

EURO-FER si riserva di apportare qualsiasi variazione ai dati indicati, al fine di migliorare il prodotto.

A richiesta è possibile realizzare produzioni personalizzate con motivi e misure non presenti in questo catalogo. Le personalizzazioni sono possibili solo per determinate quantità.

All dimensions are expressed in millimeters. The letter "H" stands for height; "L" stands for length, while the shapes of the sections are indicated with the symbols: $\neq \emptyset$ □ (flat, round or diameter, square). There may be slight differences between the dimensions indicated and the real dimensions, precisely because each creation is produced in large part by the craftsman's hand.

(ca.) - Because of their peculiarity, the measures of forged bars could be subjected to small variations due to their particular working process.

EURO-FER retains the right to change the specification indicated in order to improve the product.

Personalized creations with patterns and sizes not illustrated in this catalogues can be ordered on request. Personalized work can be performed only for certain quantities.

- .AL** Articolo realizzato in alluminio
Item made of Aluminum
- .B** Borchia svasata
Iron bush with countersunk hole
- .CI** Articolo in ghisa
Item made of Cast Iron
- .CS** Articolo in Fusione
Item made of Cast Steel
- .CO** Superficie tipo 'Corteccia'
"Bark" type surface
- .D** Misura intermedia tra l'articolo standard e la versione .E
Intermediate size between the standard item and the .E version (lightened or smaller)
- .E** modello come l'articolo di riferimenti ma 'alleggerito' e quindi più economico
Item similar to article of reference (same item number) but 'lightened' or smaller and therefore cheaper
- .ES** modello España
Identifies the 'España' models, popular in particular markets
- .R** Borchia Rullata
Iron bush with rolled surface
- .RM** Rigato e Martellato
Fluted and hammered profile
- .S** Smussato
Edged corners profile
- .ZC** *Zincato a Caldo
**Hot-dip galvanized item*
- .ZF** *Zincato a Freddo
**Cold galvanized item*

Liquirizia Modello Rigato, Martellato e Attorcigliato
Liquorice *Fluted, hammered and twisted profile*
Linea Liberty, articoli che possono includere particolari in ghisa o in ferro fuso.
The Liberty Line identifies items that can include parts made of cast iron or cast steel.



Modello depositato
Patent pending

Fiori da entrambi i lati
Flowers on both sides

* Ricordiamo che il trattamento di zincatura (a caldo o a freddo) serve a proteggere gli articoli in ferro dalla corrosione, non è un trattamento di finitura estetica.

Euro-Fer Spa non accetta reclami dovuti all'aspetto della zincatura (opaca o lucida, chiara o scura, presenza di cenere o gocce dal bagno di zinco, etc.).

*We remind you that the galvanizing treatment (hot or cold) is used to protect iron products from corrosion, it is not an aesthetic finishing treatment.

Euro-Fer Spa doesn't accept complaints regarding the shape of the galvanizing (shiny or matt, light or dark, ashes or drops from the zinc bath, etc.).

Nuovo articolo
New item **NEW**

TERMINALI / ENDS / FINITIONS

———— a freddo / cold cut / à froid ————

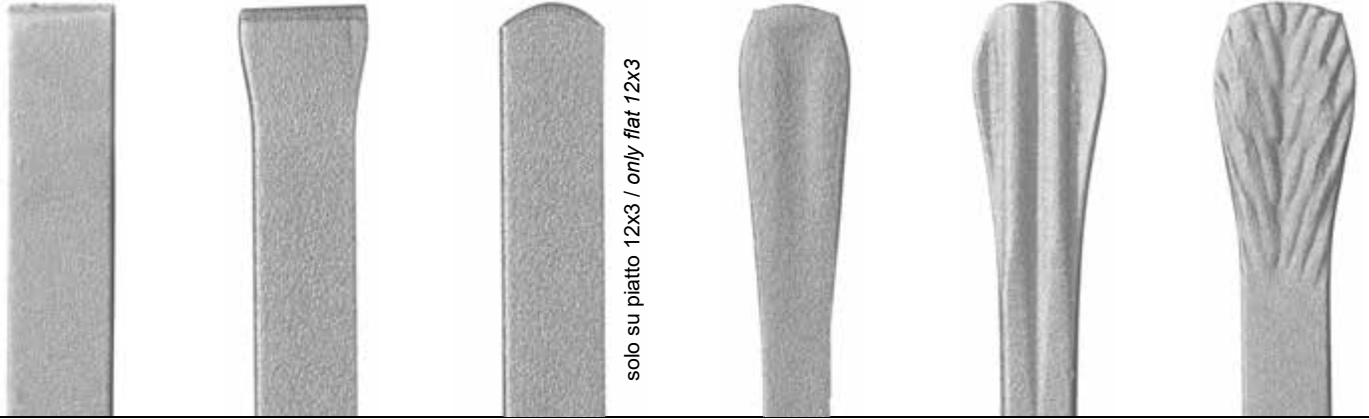

solo su piatto 12x3 / only flat 12x3

tranciato dritto
straight cut
coupe droite

TD

tranciato punta
pointed cut
coupe pointu

TP

tranciato arrotondato
rounded cut
coupe ronde

PA

rastremato liscio
smooth tapered
effilé lisse

RL

rastremato rigato
tapered and fluted
effilé rayé

RR

a "spina di pesce"
"fish bone"
à chevrons

SP

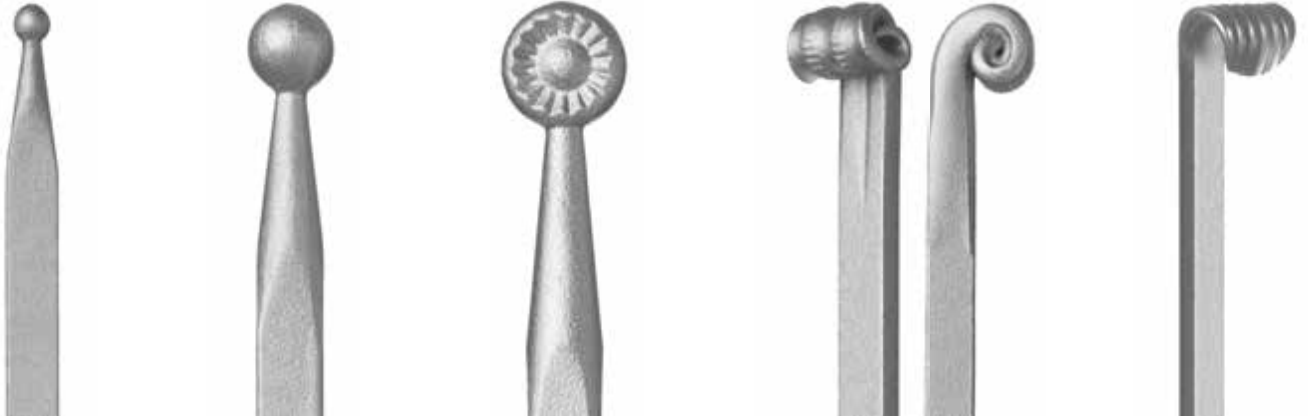

pallina piccola
small ball
petite boule

PP

pallina grande
large ball
grosse boule

PG

pallina "a sole"
sun ball
boule "soleil"

PS

chiocciola rigata
fluted spiral
escargot rayé

CR

uncino rigato
fluted hook
crochet rayé

UR

———— a freddo / cold cut / à froid ————



chiocciola schiacciata
pressed spiral
escargot écrasé

CS

nocciolina a caldo
peanut (heat forging)
cacahuète à chaud

NC

schiacciata a freddo liscia
cold-pressed
écrasée à froid

SF

schiacciata a freddo rigata
cold fluted pressed
écrasée et rayée à froid

SR

TP



H.117 X L.60 mm.

- Art. 01.001 □ 8 X 8
- Art. 01.002 ≡ 16 X 4
- Art. 01.003 ≡ 10 X 5
- Art. 01.004 ≡ 12 X 6
- Art. 01.005 ≡ 20 X 6
- Art. 01.005.01 ≡ 14 X 6
- Art. 01.005.02 ≡ 20 X 4

RL



TP



H.125 X L.75 mm.

- Art. 01.005.11 ≡ 20 X 6
- Art. 01.005.12 ≡ 14 X 6
- Art. 01.005.14 ≡ 16 X 6

TP



H.135 X L.75 mm.

- Art. 01.006 □ 8 X 8
- Art. 01.007 ≡ 16 X 4
- Art. 01.008 ≡ 10 X 5
- Art. 01.009 ≡ 12 X 6
- Art. 01.010 ≡ 20 X 6
- Art. 01.010.01 ≡ 14 X 6
- Art. 01.010.02 ≡ 20 X 4

TP



H.180 X L.105 mm.

- Art. 01.010.12 ≡ 14 X 6
- Art. 01.010.14 ≡ 16 X 6

TP



H.180 X L.85 mm.

- Art. 01.011 □ 8 X 8
- Art. 01.012 ≡ 16 X 4
- Art. 01.013 ≡ 10 X 5
- Art. 01.014 ≡ 12 X 6
- Art. 01.015 ≡ 20 X 6
- Art. 01.015.01 ≡ 14 X 6
- Art. 01.015.02 ≡ 20 X 4

TP



H.220 X L.100 mm.

- Art. 01.015.10 ≡ 12 X 6

H.225 X L.100 mm.

- Art. 01.015.20 ≡ 16 X 4

TP



H.220 X L.90 mm.

- Art. 01.016 □ 8 X 8
- Art. 01.017 ≡ 16 X 4
- Art. 01.018 ≡ 12 X 6
- Art. 01.018.01 ≡ 14 X 6

TP



H.210 X L.100 mm.

- Art. 01.018.08 ≡ 16 X 4
- Art. 01.018.10 ≡ 12 X 6

TP



H.220 X L.110 mm.

- Art. 01.019 □ 8 X 8
- Art. 01.020 ≡ 16 X 4
- Art. 01.021 ≡ 10 X 5
- Art. 01.022 ≡ 12 X 6
- Art. 01.023 ≡ 14 X 6
- Art. 01.024 ≡ 20 X 6
- Art. 01.024.01 ≡ 20 X 4

TP



H.290 X L.120 mm.

- Art. 01.025 □ 8 X 8
- Art. 01.026 ≡ 16 X 4
- Art. 01.027 ≡ 10 X 5
- Art. 01.028 ≡ 12 X 6
- Art. 01.029 ≡ 14 X 6
- Art. 01.030 ≡ 20 X 6
- Art. 01.030.01 ≡ 20 X 4

TP



H.325 X L.115 mm.

- Art. 01.030.10 ≡ 16 X 6

TP



H.360 X L.125 mm.

- Art. 01.031 □ 8 X 8
- Art. 01.032 ≡ 16 X 4
- Art. 01.033 ≡ 10 X 5
- Art. 01.034 ≡ 12 X 6
- Art. 01.035 ≡ 14 X 6
- Art. 01.036 ≡ 20 X 6
- Art. 01.036.01 ≡ 20 X 4

TP

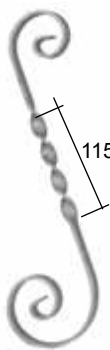

H.350 X L.100 mm.

- Art. 01.037 □ 8 X 8
- Art. 01.038 ≡ 16 X 4
- Art. 01.039 ≡ 10 X 5
- Art. 01.040 ≡ 12 X 6
- Art. 01.040.01 ≡ 14 X 6

TP



H.290 X L.100 mm.

- Art. 01.040.08 ≡ 16 X 4
- Art. 01.040.10 ≡ 12 X 6

TP



H.290 X L.120 mm.

- Art. 01.041 ≡ 16 X 4
- Art. 01.042 ≡ 12 X 6
- Art. 01.043 ≡ 14 X 6
- Art. 01.044 ≡ 20 X 6
- Art. 01.044.01 ≡ 20 X 4

TP



H.360 X L.125 mm.

- Art. 01.045 ≡ 16 X 4
- Art. 01.046 ≡ 12 X 6
- Art. 01.047 ≡ 14 X 6
- Art. 01.048 ≡ 20 X 6
- Art. 01.048.01 ≡ 20 X 4

TP



H.290 X L.125 mm.

- Art. 01.049 ≡ 16 X 4

TP



H.450 X L.95 mm.

- Art. 01.050 ≡ 16 X 4

TP



H.450 X L.125 mm.

- Art. 01.051 ≡ 16 X 4
- Art. 01.052 ≡ 20 X 6

TP























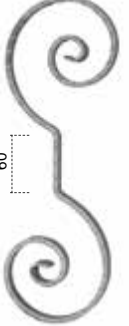
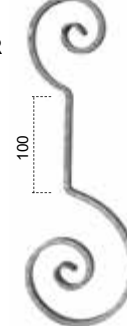

H.150 X L.105 mm.

- Art. 01.052.06 ≡ 14 X 6
- Art. 01.052.10 ≡ 16 X 6

TP

tranciato punta a freddo
cold pointed cut

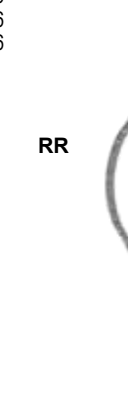

<p>RR</p> 	<p>RR</p> 	<p>RR</p> 	<p>RR</p> 	<p>RR</p> 	<p>RR</p> 
<p>Mod. Scala / Scala model H.115 X L.75 mm. Art. 01.053 ≙ 12 X 6 Art. 01.054 ≙ 14 X 6 Art. 01.054.01 ≙ 16 X 6</p>	<p>Mod. Scala / Scala model H.125 X L.90 mm. Art. 01.055 ≙ 12 X 6 Art. 01.056 ≙ 14 X 6 Art. 01.056.01 ≙ 16 X 6</p>	<p>Mod. Scala / Scala model H.130 X L.70 mm. Art. 01.057 ≙ 12 X 6 Art. 01.058 ≙ 14 X 6 Art. 01.058.01 ≙ 16 X 6</p>	<p>Mod. Scala / Scala model H.150 X L.90 mm. Art. 01.059 ≙ 12 X 6 Art. 01.059.01 ≙ 12 X 6 (liscio) Art. 01.060 ≙ 14 X 6 Art. 01.060.01 ≙ 14 X 6 (liscio) Art. 01.060.02 ≙ 16 X 6 Art. 01.060.03 ≙ 16 X 6 (liscio)</p>	<p>Mod. Scala / Scala model H.250 X L.130 mm. Art. 01.061 ≙ 12 X 6 Art. 01.061.01 ≙ 12 X 6 (liscio) Art. 01.062 ≙ 14 X 6 Art. 01.062.01 ≙ 14 X 6 (liscio) Art. 01.062.02 ≙ 16 X 6 Art. 01.062.03 ≙ 16 X 6 (liscio)</p>	<p>Mod. Scala / Scala model H.280 X L.200 mm. Art. 01.063 □ 12 X 12</p>
<p>RR</p> 	<p>RR</p> 	<p>RR</p> 	<p>RR</p> 	<p>RR</p> 	<p>TP</p> 
<p>Mod. Scala / Scala model H.230 X L.110 mm. Art. 01.064 ≙ 12 X 6 Art. 01.065 ≙ 14 X 6 Art. 01.065.01 ≙ 16 X 6</p>	<p>Mod. Scala / Scala model H.290 X L.115 mm. Art. 01.066 ≙ 12 X 6 Art. 01.066.01 ≙ 12 X 6 (liscio) Art. 01.067 ≙ 14 X 6 Art. 01.067.01 ≙ 14 X 6 (liscio) Art. 01.067.02 ≙ 16 X 6 Art. 01.067.03 ≙ 16 X 6 (liscio)</p>	<p>Mod. Scala / Scala model H.360 X L.130 mm. Art. 01.068 ≙ 12 X 6 Art. 01.068.01 ≙ 12 X 6 (liscio) Art. 01.069 ≙ 14 X 6 Art. 01.069.01 ≙ 14 X 6 (liscio) Art. 01.069.02 ≙ 16 X 6 Art. 01.069.03 ≙ 16 X 6 (liscio)</p>	<p>Mod. Scala / Scala model H.290 X L.125 mm. Art. 01.070 ≙ 12 X 6 Art. 01.070.01 ≙ 12 X 6 (liscio) Art. 01.071 ≙ 14 X 6 Art. 01.071.01 ≙ 14 X 6 (liscio) Art. 01.071.02 ≙ 16 X 6 Art. 01.071.03 ≙ 16 X 6 (liscio)</p>	<p>Mod. Scala / Scala model H.360 X L.125 mm. Art. 01.072 ≙ 12 X 6 Art. 01.072.01 ≙ 12 X 6 (liscio) Art. 01.073 ≙ 14 X 6 Art. 01.073.01 ≙ 14 X 6 (liscio) Art. 01.073.02 ≙ 16 X 6 Art. 01.073.03 ≙ 16 X 6 (liscio)</p>	<p>Mod. Scala / Scala model H.360 X L.70 mm. Art. 01.074 □ 8 X 8</p>
<p>RR</p> 	<p>RR</p> 	<p>RR</p> 	<p>RR</p> 	<p>RR</p> 	<p>RR</p> 
<p>Mod. Scala / Scala model H.360 X L.125 mm. Art. 01.075 ≙ 12 X 6 Art. 01.076 ≙ 14 X 6 Art. 01.076.01 ≙ 16 X 6</p>	<p>Mod. Scala / Scala model H.360 X L.125 mm. Art. 01.077 ≙ 12 X 6 Art. 01.078 ≙ 14 X 6 Art. 01.078.01 ≙ 16 X 6</p>	<p>Mod. Scala / Scala model H.250 X L.75 mm. Art. 01.079 ≙ 12 X 6 Art. 01.080 ≙ 14 X 6 Art. 01.080.01 ≙ 16 X 6</p>	<p>Mod. Scala / Scala model H.120 X L.80 mm. Art. 01.081 ≙ 12 X 6 Art. 01.082 ≙ 14 X 6 Art. 01.082.01 ≙ 16 X 6</p>	<p>Mod. Scala / Scala model H.100 X L.65 mm. Art. 01.083 ≙ 12 X 6 Art. 01.083.27 ≙ 14 X 6 Art. 01.083.28 ≙ 16 X 6</p>	<p>Mod. Scala / Scala model H.160 X L.80 mm. Art. 01.083.01 ≙ 12 X 6 Art. 01.083.02 ≙ 14 X 6 Art. 01.083.29 ≙ 16 X 6</p>
<p>RR</p> 	<p>RR</p> 	<p>RR</p> 	<p>RR</p> 	<p>RR</p> 	<p>RR</p> 
<p>Mod. Scala / Scala model H.210 X L.115 mm. Art. 01.083.03 ≙ 12 X 6 Art. 01.083.04 ≙ 14 X 6 Art. 01.083.30 ≙ 16 X 6</p>	<p>Mod. Scala / Scala model H.240 X L.110 mm. Art. 01.083.07 ≙ 12 X 6 Art. 01.083.08 ≙ 14 X 6 Art. 01.083.32 ≙ 16 X 6</p>	<p>Mod. Scala / Scala model H.290 X L.110 mm. Art. 01.083.09 ≙ 12 X 6 Art. 01.083.10 ≙ 14 X 6 Art. 01.083.33 ≙ 16 X 6</p>	<p>Mod. Scala / Scala model H.230 X L.120 mm. Art. 01.083.11 ≙ 12 X 6 Art. 01.083.12 ≙ 14 X 6 Art. 01.083.34 ≙ 16 X 6</p>	<p>Mod. Scala / Scala model H.230 X L.120 mm. Art. 01.083.13 ≙ 12 X 6 Art. 01.083.14 ≙ 14 X 6 Art. 01.083.35 ≙ 16 X 6</p>	<p>Mod. Scala / Scala model H.325 X L.80 mm. Art. 01.083.15 ≙ 12 X 6 Art. 01.083.16 ≙ 14 X 6 Art. 01.083.36 ≙ 16 X 6</p>

Tutte le parti di questo catalogo - foto comprese - sono di proprietà Euro-Fer. La riproduzione, anche parziale, è vietata in ogni forma e con ogni mezzo. / Every part of this catalogue - photos included - is Euro-Fer's property. All forms of copying are strictly prohibited.



RR
Mod. Scala / Scala model
H.145 X L.75 mm.
Art. 01.083.17 ≙ 12 X 6
Art. 01.083.18 ≙ 14 X 6
Art. 01.083.37 ≙ 16 X 6



RR
Mod. Scala / Scala model
H.110 X L.60 mm.
Art. 01.083.19 ≙ 12 X 6
Art. 01.083.20 ≙ 14 X 6
Art. 01.083.38 ≙ 16 X 6



RR
Mod. Scala / Scala model
H.200 X L.100 mm.
Art. 01.083.21 ≙ 14 X 6
Art. 01.083.39 ≙ 16 X 6



RR
Mod. Scala / Scala model
H.220 X L.110 mm.
Art. 01.083.22 ≙ 14 X 6
Art. 01.083.41 ≙ 16 X 6



RR
Mod. Scala / Scala model
H.380 X L.180 mm.
Art. 01.083.23 ≙ 12 X 6
Art. 01.083.24 ≙ 14 X 6
Art. 01.083.43 ≙ 16 X 6



RR
Mod. Scala / Scala model
H.310 X L.35 mm.
Art. 01.083.25 ≙ 14 X 6
Art. 01.083.44 ≙ 16 X 6



RR
Mod. Scala / Scala model
H.420 X L.35 mm.
Art. 01.083.26 ≙ 14 X 6



RR
Liscio / Smooth
H.220 X L.110 mm.
Art. 01.086.01 ≙ 12 X 6
Art. 01.086.11 ≙ 16 X 8

Mod. Scala / Scala model
H.220 X L.110 mm.
Art. 01.086.02 ≙ 12 X 6

Martellato / Hammered
H.220 x L.110 mm
Art. 01.086.51 ≙ 12 x 6



RR
Liscio / Smooth
H.200 X L.100 mm.
Art. 01.086.03 ≙ 12 X 6
Art. 01.086.13 ≙ 16 X 8

Mod. Scala / Scala model
H.200 X L.100 mm.
Art. 01.086.04 ≙ 12 X 6
Art. 01.086.14 ≙ 16 X 8

Martellato / Hammered
H.200 x L.100 mm
Art. 01.086.50 ≙ 12 x 6

RR
rastremato rigato a caldo
hot tapered and fluted



NEW



H.140 X L.75 mm.
Art. 01.086.70 ≙ 12 X 4
Art. 01.086.71 ≙ 14 X 4
Art. 01.086.72 ≙ 16 X 4



SF
H.115 X L.80 mm.
Art. 01.084 □ 8 X 8



SF
H.115 X L.80 mm.
Art. 01.084.01 Ø 8



SR
Mod. Scala / Scala model
H.120 X L.75 mm.
Art. 01.085 □ 8 X 8



RL
Mod. Scala / Scala model
H.120 X L.75 mm.
Art. 01.086 □ 8 X 8



RR
Martellato / Hammered
H.115 x L.75 mm
Art. 01.086.20 ≙ 12 x 6



SR
H.180 X L.110 mm.
Art. 01.087 ≙ 12 X 6

Tutte le parti di questo catalogo - foto comprese - sono di proprietà Euro-Fer. La riproduzione, anche parziale, è vietata in ogni forma e con ogni mezzo. / Every part of this catalogue - photos included - is Euro-Fer's property. All forms of copying are strictly prohibited.

SP
ricci e terminali
"a spina di pesce"
"fish bone"
scrolls and end



SP



H.100 X L.60 mm.
Art. 01.086.05 ≙ 12 X 6
Art. 01.086.06 ≙ 14 X 6
Art. 01.086.15 ≙ 16 X 6
Art. 01.086.18 ≙ 20 X 6

SP



H.125 X L.75 mm.
Art. 01.086.07 ≙ 12 X 6
Art. 01.086.08 ≙ 14 X 6
Art. 01.086.16 ≙ 16 X 6
Art. 01.086.19 ≙ 20 X 6

SP



H.150 X L.80 mm.
Art. 01.086.09 ≙ 12 X 6
Art. 01.086.10 ≙ 14 X 6
Art. 01.086.17 ≙ 16 X 6
Art. 01.086.21 ≙ 20 X 6

SP



H.180 X L.105 mm.
Art. 01.086.24 ≙ 14 X 6
Art. 01.086.25 ≙ 16 X 6
Art. 01.086.26 ≙ 20 X 6

SP



H.200 X L.125 mm.
Art. 01.086.30 ≙ 14 X 6
Art. 01.086.31 ≙ 16 X 6

SP



H.100 X L.65 mm.
Art. 01.086.35 ≙ 14 X 6
Art. 01.086.36 ≙ 16 X 6
Art. 01.086.37 ≙ 20 X 6

SP



H.110 X L.90 mm.
Art. 01.086.40 ≙ 14 X 6
Art. 01.086.41 ≙ 16 X 6
Art. 01.086.42 ≙ 20 X 6

SP



H.150 X L.105 mm.
Art. 01.086.45 ≙ 14 X 6
Art. 01.086.46 ≙ 16 X 6
Art. 01.086.47 ≙ 20 X 6

SP



H.180 X L.125 mm.
Art. 01.086.60 ≙ 14 X 6
Art. 01.086.61 ≙ 16 X 6
Art. 01.086.52 ≙ 20 X 6

SP



H.110 X L.65 mm.
Art. 01.086.62 ≙ 12 X 6
Art. 01.086.63 ≙ 14 X 6
Art. 01.086.64 ≙ 16 X 6

NEW

SP

NEW



H.350 X L.110 mm.
Art. 01.086.80 ≙ 12 X 6
Art. 01.086.81 ≙ 14 X 6
Art. 01.086.82 ≙ 16 X 6

SP

NEW



H.270 X L.110 mm.
Art. 01.086.83 ≙ 12 X 6
Art. 01.086.84 ≙ 14 X 6
Art. 01.086.85 ≙ 16 X 6

SF



H.180 X L.95 mm.
Art. 01.087.01 □ 10 X 10
Art. 01.087.02 ∅ 8

SF



H.180 X L.95 mm.
Art. 01.088 □ 8 X 8

RR



Mod. Scala / Scala model
H.240 X L.50 mm.
Art. 01.088.01 ≙ 12 X 6
Art. 01.088.02 ≙ 14 X 6

SF



H.250 X L.100 mm.
Art. 01.088.03 □ 8 X 8
Art. 01.088.04 □ 10 X 10
Art. 01.088.05 ∅ 8

SF



H.140 X L.60 mm.
Art. 01.088.06 ∅ 8

SF



H.220 X L.110 mm.
Art. 01.089 □ 8 X 8

SF



H.220 X L.110 mm.
Art. 01.089.01 □ 10 X 10
Art. 01.089.02 ∅ 8

SF



H.170 X L.77 mm.
Art. 01.089.03 ∅ 8

SF



H.290 X L.110 mm.
Art. 01.090 □ 8 X 8

SF























H.290 X L.110 mm.
Art. 01.090.01 □ 10 X 10
Art. 01.090.02 ∅ 8

Attenzione cambio codice / Notice new code

SF	SF	RR	RR	RR	RR	RR	RR
H.340 x L.90 mm	H.360 X L.110 mm.	H.100 X L.75 mm.	H.125 X L.70 mm.	Martellato / Hammered		H.175 X L.105 mm.	H.280 X L.110 mm.
Art. 01.090.05 ≡ 8 X 8	Art. 01.091.01 ≡ 8 X 8	Art. 01.091.03 ≡ 12 X 6	Art. 01.091.05 ≡ 16 X 6	Art. 01.091.06 ≡ 12 X 6	Art. 01.091.07 ≡ 12 X 6	Art. 01.091.08 ≡ 14 X 6	Art. 01.091.09 ≡ 12 X 6
Art. 01.090.06 ≡ 10 X 10	Art. 01.091.02 Ø 8	Art. 01.091.04 ≡ 14 X 6					Art. 01.091.10 ≡ 14 X 6
		RR	TP				
H.190 X L.75 mm.	H.230 X L.110 mm.	H.360 X L.110 mm.	H.430 X L.128 mm.	H.200 X L.100 mm.	H.220 X L.110 mm.		
Art. 01.091.11 ≡ 12 X 6	Art. 01.091.14 ≡ 10 X 10	Art. 01.091.15 ≡ 12 X 6	Art. 01.091.16 ≡ 16 X 8	Art. 01.091.17 ≡ 14 X 6	Art. 01.091.18 ≡ 14 X 6		
Art. 01.091.12 ≡ 16 X 6				Art. 01.091.21 ≡ 16 X 6			
Art. 01.091.13 ≡ 20 X 6							
RR	RR	RR	RR	RR	RR	RR	RR
H.95 X L.60 mm.	H.105 X L.70 mm.	H.115 X L.75 mm.	H.110 X L.70 mm.	H.120 X L.70 mm.	H.125 X L.70 mm.	H.130 X L.70 mm.	
Art. 01.092 ≡ 12 X 6	Art. 01.093 ≡ 12 X 6	Art. 01.094 ≡ 12 X 6	Art. 01.094.02 ≡ 12 X 6	Art. 01.095 ≡ 12 X 6	Art. 01.095.10 ≡ 12 X 6	Art. 01.096 ≡ 12 X 6	
Art. 01.092.01 ≡ 14 X 6	Art. 01.093.01 ≡ 14 X 6	Art. 01.094.01 ≡ 14 X 6	Art. 01.094.03 ≡ 14 X 6	Art. 01.095.01 ≡ 14 X 6		Art. 01.096.01 ≡ 14 X 6	
Art. 01.092.02 ≡ 16 X 6	Art. 01.093.02 ≡ 16 X 6	Art. 01.094.04 ≡ 16 X 6	Art. 01.094.05 ≡ 16 X 6	Art. 01.095.02 ≡ 16 X 6		Art. 01.096.02 ≡ 16 X 6	
RR	RR	RR	RR	RR	RR	RR	RR
H.150 X L.75 mm.	H.140 X L.95 mm.	H.135 X L.75 mm.	H.120 X L.60 mm.	H.150 X L.70 mm.		H.230 X L.115 mm.	
Art. 01.097 ≡ 12 X 6	Art. 01.098 ≡ 12 X 6	Art. 01.098.03 ≡ 12 X 6	Art. 01.098.05 ≡ 16 X 6	Art. 01.099 ≡ 12 X 6	Art. 01.100 ≡ 12 X 6	Art. 01.101 ≡ 12 X 6	
Art. 01.097.01 ≡ 14 X 6	Art. 01.098.01 ≡ 14 X 6			Art. 01.099.01 ≡ 14 X 6	Art. 01.100.01 ≡ 14 X 6	Art. 01.101.01 ≡ 14 X 6	
Art. 01.097.02 ≡ 16 X 6	Art. 01.098.04 ≡ 16 X 6			Art. 01.099.02 ≡ 16 X 6	Art. 01.100.02 ≡ 16 X 6	Art. 01.101.03 ≡ 16 X 6	

Tutte le parti di questo catalogo - foto comprese - sono di proprietà Euro-Fer. La riproduzione, anche parziale, è vietata in ogni forma e con ogni mezzo. / Every part of this catalogue - photos included - is Euro-Fer's property. All forms of copying are strictly prohibited.

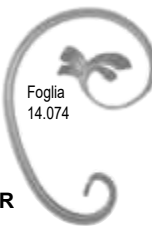
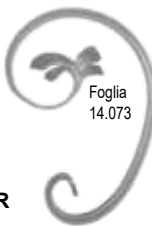
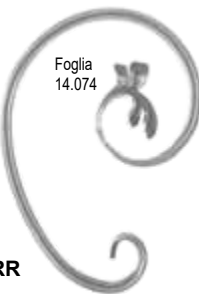
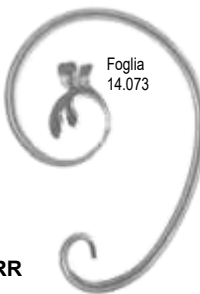
<p>RR</p>  <p>H.220 X L.110 mm. Art. 01.101.02 ≙ 20 X 6</p>	<p>RR</p>  <p>H.260 X L.115 mm. Art. 01.102 ≙ 12 X 6 Art. 01.102.01 ≙ 14 X 6 Art. 01.102.02 ≙ 16 X 6</p>	<p>RR</p>  <p>H.115 X L.95 mm. Art. 01.103 ≙ 12 X 6 Art. 01.103.01 ≙ 14 X 6 Art. 01.103.02 ≙ 16 X 6</p>	<p>TP</p>  <p>H.230 X L.80 mm. Art. 01.104 ≙ 12 X 6 Art. 01.104.01 ≙ 14 X 6 Art. 01.104.02 ≙ 16 X 6</p>	<p>RR</p>  <p>H.250 X L.75 mm. Art. 01.105 ≙ 12 X 6 Art. 01.105.01 ≙ 14 X 6 Art. 01.105.03 ≙ 16 X 6</p>	<p>RR</p>  <p>H.250 X L.100 mm. Art. 01.105.02 □ 10 X 10</p>
<p>RR</p>  <p>H.360 X L.125 mm. Art. 01.106 ≙ 12 X 6 Art. 01.106.01 ≙ 14 X 6 Art. 01.106.02 ≙ 16 X 6</p>	<p>RR</p>  <p>H.360 X L.130 mm. Art. 01.107 □ 12 X 12 Art. 01.107.02 □ 14 X 14</p>	<p>SF</p>  <p>H.400 X L.145 mm. Art. 01.107.01 □ 12 X 12</p>	<p>RR</p>  <p>H.100 X L.65 mm. Art. 01.108 ≙ 12 X 6 Art. 01.108.01 ≙ 14 X 6 Art. 01.108.02 ≙ 16 X 6</p>	<p>RR</p>  <p>H.120 X L.80 mm. Art. 01.109 ≙ 12 X 6 Art. 01.109.01 ≙ 14 X 6 Art. 01.109.02 ≙ 16 X 6</p>	<p>RR</p>  <p>H.135 X L.150 mm. Art. 01.110 ≙ 14 X 6 Art. 01.111 ≙ 16 X 6</p>
<p>RR</p>  <p>Rigato / Fluted H.300 X L.70 mm. Art. 01.113 ≙ 16 X 8</p>	<p>RR</p>  <p>H.460 X L.90 mm. Art. 01.113.01 ≙ 12 X 6</p>	<p>RR</p>  <p>Modello Scala / Scala Model H.460 X L.90 mm. Art. 01.113.02 ≙ 12 X 6</p>	<p>RR</p>  <p>Rigato / Fluted H.360 X L.110 mm. Art. 01.114 ≙ 12 X 6</p>	<p>TA</p>  <p>H.240 X L.55 mm. Art. 01.114.01 ≙ 12 X 3</p>	<p>TA</p>  <p>H.250 X L.55 mm. Art. 01.114.02 ≙ 12 X 3</p>
<p>TD</p>  <p>H.270 X L.90 mm. Art. 01.114.03 ≙ 12 X 5</p>	<p>TA</p>  <p>H.280 X L.45 mm. Art. 01.114.04 ≙ 12 X 3</p>	<p>RR</p>  <p>Foglia 14.074 Rigato / Fluted H.180 X L.120 mm. Art. 01.114.05 ≙ 16 X 8</p>	<p>RR</p>  <p>Foglia 14.073 Rigato / Fluted H.180 X L.120 mm. Art. 01.114.06 ≙ 16 X 8</p>	<p>RR</p>  <p>Foglia 14.074 Rigato / Fluted H.210 X L.150 mm. Art. 01.114.07 ≙ 16 X 8</p>	<p>RR</p>  <p>Foglia 14.073 Rigato / Fluted H.210 X L.150 mm. Art. 01.114.08 ≙ 16 X 8</p>

Tutte le parti di questo catalogo - foto comprese - sono di proprietà Euro-Fer. La riproduzione, anche parziale, è vietata in ogni forma e con ogni mezzo. / Every part of this catalogue - photos included - is Euro-Fer's property. All forms of copying are strictly prohibited.

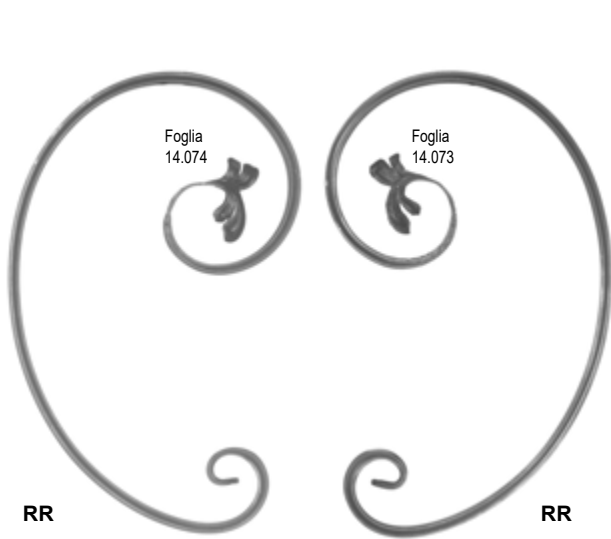

RR

RR

Rigato / Fluted
H.360 X L.230 mm.
Art. 01.114.09 ≙ 16 X 8

Rigato / Fluted
H.360 X L.230 mm.
Art. 01.114.10 ≙ 16 X 8

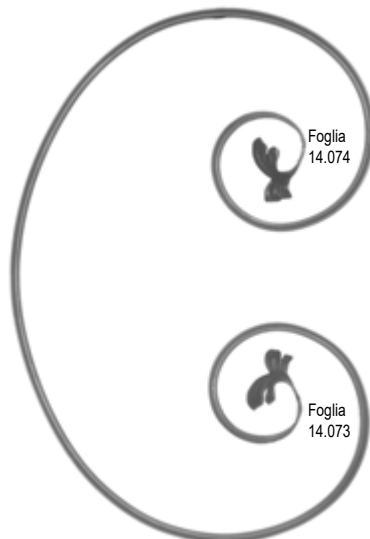

Rigato / Fluted
H.480 X L.340 mm.
Art. 01.114.11 ≙ 16 X 8



Rigato / Fluted
H.480 X L.320 mm.
Art. 01.114.12 ≙ 16 X 8



Rigato / Fluted
H.410 X L.150 mm.
Art. 01.114.13 ≙ 16 X 8



Rigato / Fluted
H.410 X L.150 mm.
Art. 01.114.14 ≙ 16 X 8



Rigato / Fluted
H.510 X L.270 mm.
Art. 01.114.15 ≙ 16 X 8



Rigato / Fluted
H.510 X L.270 mm.
Art. 01.114.16 ≙ 16 X 8

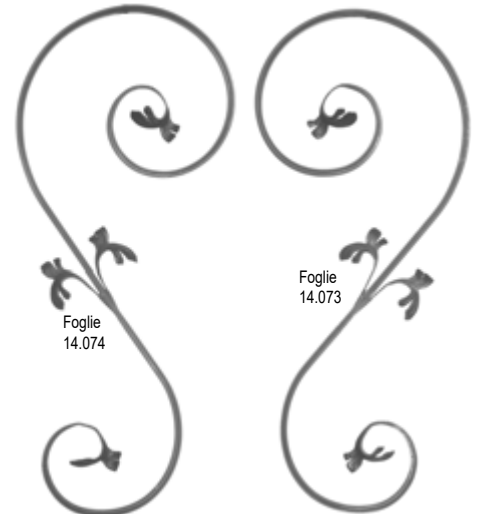

Rigato / Fluted
H.610 X L.250 mm.
Art. 01.114.17 ≙ 16 X 8

Rigato / Fluted
H.610 X L.250 mm.
Art. 01.114.18 ≙ 16 X 8



Rigato / Fluted
H.240 X L.80 mm.
Art. 01.114.19 ≙ 16 X 8



Rigato / Fluted
H.240 X L.80 mm.
Art. 01.114.20 ≙ 16 X 8



Tutte le parti di questo catalogo - foto comprese - sono di proprietà Euro-Fer. La riproduzione, anche parziale, è vietata in ogni forma e con ogni mezzo. / Every part of this catalogue - photos included - is Euro-Fer's property. All forms of copying are strictly prohibited.



Rigato / Fluted
H.190 X L.110 mm.
Art. 01.114.21 ≙ 16 X 8



Rigato / Fluted
H.270 X L.190 mm.
Art. 01.114.22 ≙ 16 X 8



Rigato / Fluted
H.350 X L.220 mm.
Art. 01.114.23 ≙ 16 X 8



Rigato / Fluted
H.210 X L.150 mm.
Art. 01.114.24 ≙ 16 X 8



Rigato / Fluted
H.360 X L.230 mm.
Art. 01.114.26 ≙ 16 X 8



H.400 X L.150 mm.
Art. 01.115 ≙ 12 X 6



H.400 X L.150 mm.
Art. 01.116 ≙ 12 X 6



H.205 X L.150 mm.
Art. 01.117 ≙ 12 X 6
Art. 01.117.01 ≙ 14 X 6
Art. 01.117.02 ≙ 16 X 6



H.250 X L.150 mm.
Art. 01.118 ≙ 12 X 6
Art. 01.118.03 ≙ 14 X 6
Art. 01.118.04 ≙ 16 X 6
Art. 01.118.05
≙ 12 X 6 Mod. Scala / Scala Model
Art. 01.118.06
≙ 16 X 5 Martellato / Hammered

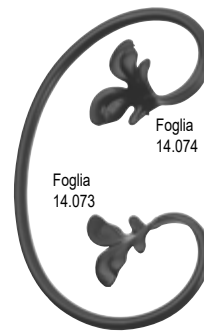

H.250 X L.150 mm.
Art. 01.118.01 Ø 10



Liscio / Smooth
H.500 x L.310 mm
Art. 01.118.10 ≙ 12 x 6



H.200 X L.125 mm.
Art. 01.119 ≙ 12 X 6



H.200 X L.125 mm.
Art. 01.120 ≙ 12 X 6



H.115 X L.100 mm.
Art. 01.120.01 ≙ 12 X 6

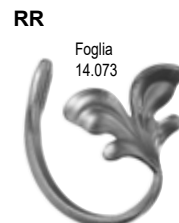

H.115 X L.100 mm.
Art. 01.120.02 ≙ 12 X 6



H.80 X L.325 mm.
Art. 01.121 ≙ 12 X 6
Art. 01.121.01 ≙ 14 X 6

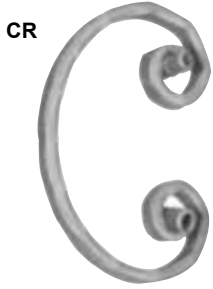

CR
Martellato / Hammered
H.175 X L.115 mm.
Art. 01.122 ≙ 16 X 8



CR
Martellato / Hammered
H.125 X L.80 mm.
Art. 01.123 ≙ 16 X 8



CR
Martellato / Hammered
H.115 X L.65 mm.
Art. 01.124 ≙ 16 X 8



CR
Foglia 14.081
Martellato / Hammered
H.225 X L.140 mm.
Art. 01.125 ≙ 16 X 8



CR
Foglia sx 14.074.01
Martellato / Hammered
H.190 X L.125 mm.
Art. 01.126 ≙ 16 X 8



CR
Foglia dx 14.074.02
Martellato / Hammered
H.190 X L.125 mm.
Art. 01.127 ≙ 16 X 8



CR
Foglia 14.060
Martellato / Hammered
H.270 X L.85 mm.
Art. 01.128 ≙ 16 X 8

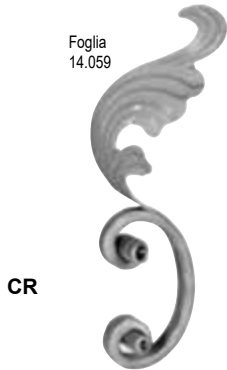

CR
Foglia 14.059
Martellato / Hammered
H.270 X L.85 mm.
Art. 01.129 ≙ 16 X 8



CR
Martellato / Hammered
H.310 X L.190 mm.
Art. 01.130 ≙ 16 X 8



RR
Tondo / Round
H.290 X L.130 mm.
Art. 01.131.01 Ø 10
Art. 01.131.02 Ø 12
Art. 01.131.30 Ø 14
Art. 01.131.31 Ø 16



RR
Tondo / Round
H.360 X L.130 mm.
Art. 01.131.03 Ø 10
Art. 01.131.04 Ø 12
Art. 01.131.32 Ø 14
Art. 01.131.33 Ø 16



RR
Tondo / Round
H.360 X L.130 mm.
Art. 01.131.05 Ø 10
Art. 01.131.06 Ø 12
Art. 01.131.34 Ø 14
Art. 01.131.35 Ø 16



RR
Tondo / Round
H.135 X L.70 mm.
Art. 01.131.07 Ø 10
Art. 01.131.08 Ø 12



RR
Tondo / Round
H.140 X L.85 mm.
Art. 01.131.09 Ø 10
Art. 01.131.10 Ø 12



RR
Tondo / Round
H.230 X L.110 mm.
Art. 01.131.11 Ø 10
Art. 01.131.12 Ø 12
Art. 01.131.36 Ø 14
Art. 01.131.37 Ø 16



RR
Tondo / Round
H.220 X L.110 mm.
Art. 01.131.13 Ø 10
Art. 01.131.14 Ø 12
Art. 01.131.38 Ø 14
Art. 01.131.39 Ø 16

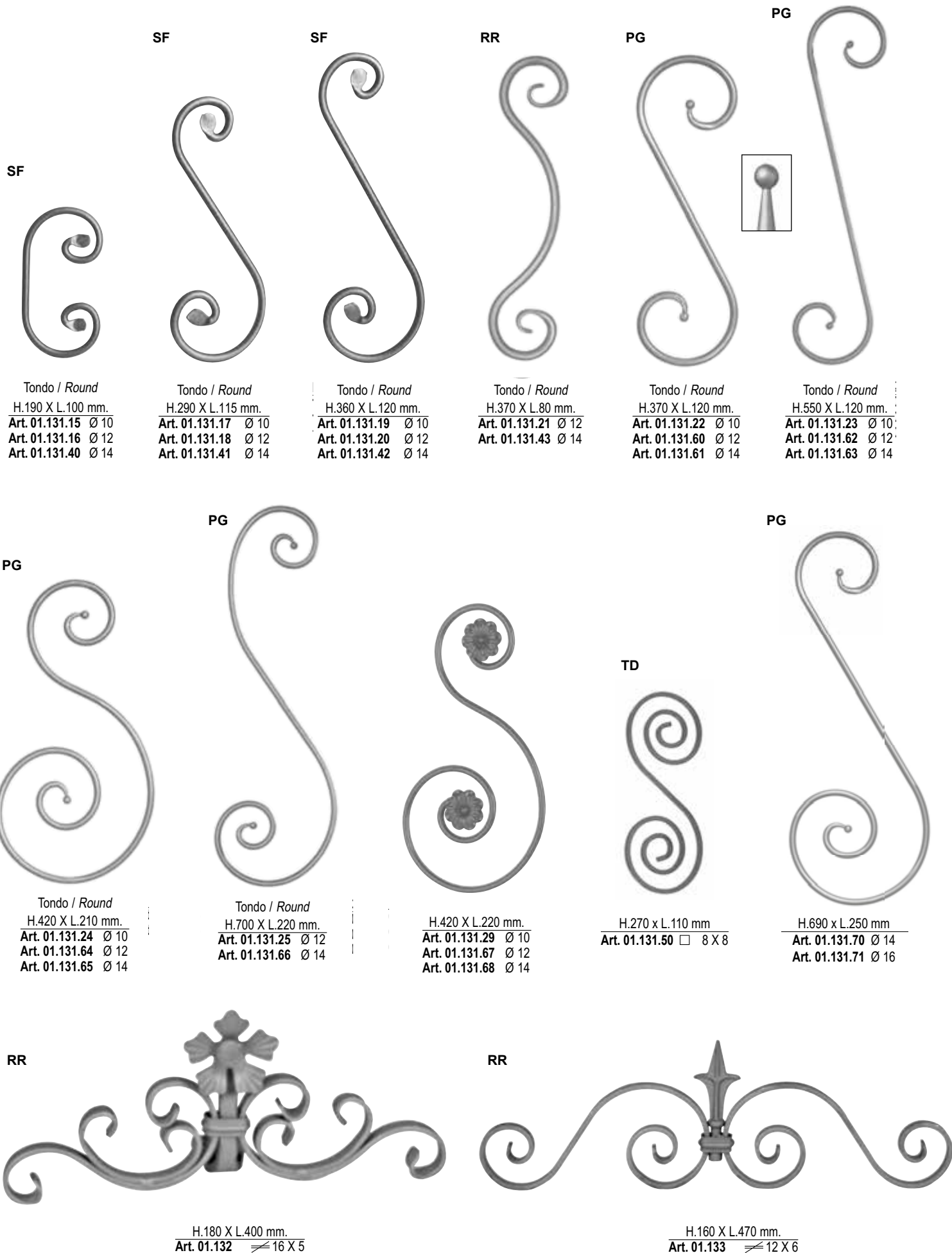

RR



H.200 X L.730 mm.
Art. 01.133.01 ≙ 12 X 6

RR



H.200 X L.770 mm.
Art. 01.134 ≙ 16 X 4

RR



H.250 X L.900 mm.
Art. 01.135 ≙ 16 X 4

RR



H.300 X L.900 mm.
Art. 01.136 ≙ 20 X 5

RR



Modello Scala / Scala Model
H.470 X L.750 mm.
Art. 01.136.01 ≙ 14 X 6

RR



Martellato / Hammered
H.400 X L.950 mm.
Art. 01.136.02 ≙ 25 X 6

RR



Martellato sinistro / Hammered left
H.530 X L.1630 mm.
Art. 01.136.03 ≙ 25 X 6

Martellato destro / Hammered right
H.530 X L.1630 mm.
Art. 01.136.04 ≙ 25 X 6

Tutte le parti di questo catalogo - foto comprese - sono di proprietà Euro-Fer. La riproduzione, anche parziale, è vietata in ogni forma e con ogni mezzo. / Every part of this catalogue - photos included - is Euro-Fer's property. All forms of copying are strictly prohibited.



H.480 - Ø 550
Art. 01.136.05
 Base 40 x 40



H.480 - Ø 550
Art. 01.136.06
 Base 110 x 110



H.580 X L.1250 mm.

Art. 01.136.07 □ 16 X 16 Liscio sinistro / *Smooth left*
Art. 01.136.09 □ 16 X 16 Martellato sinistro / *Hammered left*

H.580 X L.1250 mm.

Art. 01.136.08 □ 16 X 16 Liscio destro / *Smooth right*
Art. 01.136.10 □ 16 X 16 Martellato destro / *Hammered right*



H.560 X L.1720 mm.

Art. 01.136.11 □ 16 X 16 Liscio / Smooth

Art. 01.136.12 □ 16 X 16 Martellato / Hammered

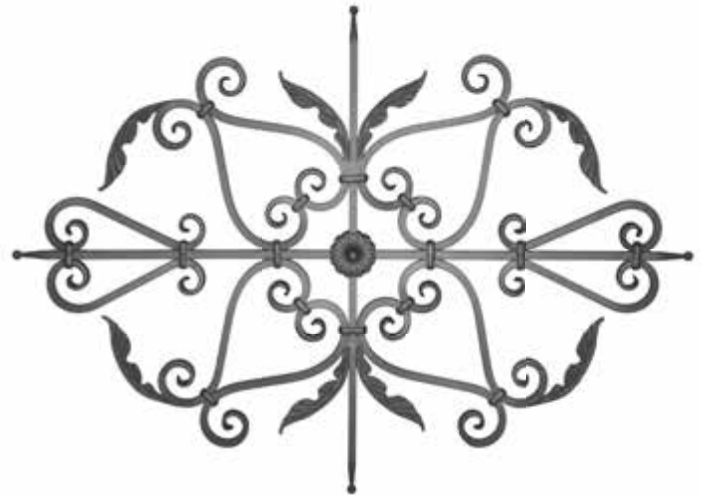

H.1420 X L.1030 mm.

Art. 01.136.13 □ 16 X 16 Liscio / Smooth

Art. 01.136.14 □ 16 X 16 Martellato / Hammered



H.1230 X L.1890 mm.

Art. 01.136.15 □ 16 X 16 Liscio sinistro / Smooth left

Art. 01.136.17 □ 16 X 16 Martellato sinistro / Hammered left



H.1230 X L.1890 mm.

Art. 01.136.16 □ 16 X 16 Liscio destro / Smooth right

Art. 01.136.18 □ 16 X 16 Martellato destro / Hammered right



Tutte le parti di questo catalogo - foto comprese - sono di proprietà Euro-Fer. La riproduzione, anche parziale, è vietata in ogni forma e con ogni mezzo. / Every part of this catalogue - photos included - is Euro-Fer's property. All forms of copying are strictly prohibited.

UR



H.260 x L.100 mm
Liscio / Smooth

Art. 01.136.40 □ 14 X14mm
Art. 01.136.41 □ 12 X12mm
Martellato / Hammered
Art. 01.136.42 □ 14 X14mm
Art. 01.136.43 □ 12 X12mm

UR



H.400 x L.110 mm
Liscio / Smooth

Art. 01.136.46 □ 14 X14mm
Art. 01.136.47 □ 12 X12mm
Martellato / Hammered
Art. 01.136.48 □ 14 X14mm
Art. 01.136.49 □ 12 X12mm

UR



H.200 X L.95 mm.
Art. 01.137 □ 16 X 16

UR



Martellato / Hammered
H.200 X L.95 mm.
Art. 01.138 □ 16 X 16

UR



H.200 X L.95 mm.
Art. 01.139 □ 16 X 16

UR



Martellato / Hammered
H.200 X L.95 mm.
Art. 01.140 □ 16 X 16

UR



H.220 X L.115 mm.
Art. 01.141 □ 16 X 16

UR



Martellato / Hammered
H.220 X L.115 mm.
Art. 01.142 □ 16 X 16

UR



H.240 X L.160 mm.
Art. 01.143 □ 16 X 16

UR



Martellato / Hammered
H.240 X L.160 mm.
Art. 01.144 □ 16 X 16

UR



H.270 X L.100 mm.
Art. 01.145 □ 16 X 16

UR



Martellato / Hammered
H.270 X L.100 mm.
Art. 01.146 □ 16 X 16

UR



H.260 X L.135 mm.
Art. 01.147 □ 16 X 16

UR



Martellato / Hammered
H.260 X L.135 mm.
Art. 01.148 □ 16 X 16

UR



H.280 X L.105 mm.
Art. 01.149 □ 16 X 16

UR



Martellato / Hammered
H.280 X L.105 mm.
Art. 01.150 □ 16 X 16

UR



H.370 X L.190 mm.
Art. 01.151 □ 16 X 16

UR



Martellato / Hammered
H.370 X L.190 mm.
Art. 01.152 □ 16 X 16

UR



H.450 X L.200 mm.
Art. 01.153 □ 16 X 16

UR



Martellato / Hammered
H.450 X L.200 mm.
Art. 01.154 □ 16 X 16

UR



H.490 X L.170 mm.
Art. 01.155 □ 16 X 16

UR



Martellato / Hammered
H.490 X L.170 mm.
Art. 01.156 □ 16 X 16

UR



H.510 X L.195 mm.
Art. 01.157 □ 16 X 16

UR



Martellato / Hammered
H.510 X L.195 mm.
Art. 01.158 □ 16 X 16



H.540 X L.200 mm.
Art. 01.159 □ 16 X 16



Martellato / Hammered
H.540 X L.200 mm.
Art. 01.160 □ 16 X 16



H.810 X L.540 mm.
Art. 01.161 □ 16 X 16



Martellato / Hammered
H.810 X L.540 mm.
Art. 01.162 □ 16 X 16



H.200 X L.85 mm.
Art. 01.163 □ 16 X 16



Martellato / Hammered
H.200 X L.85 mm.
Art. 01.164 □ 16 X 16



H.260 X L.95 mm.
Art. 01.165 □ 16 X 16



Martellato / Hammered
H.260 X L.95 mm.
Art. 01.166 □ 16 X 16



H.365 X L.170 mm.
Art. 01.167 □ 16 X 16



Martellato / Hammered
H.365 X L.170 mm.
Art. 01.168 □ 16 X 16



H.400 X L.185 mm.
Art. 01.169 □ 16 X 16

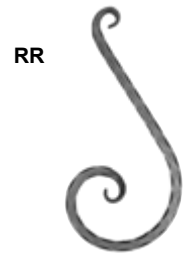

Martellato / Hammered
H.400 X L.185 mm.
Art. 01.170 □ 16 X 16



H.415 X L.190 mm.
Art. 01.171 □ 16 X 16



Martellato / Hammered
H.415 X L.190 mm.
Art. 01.172 □ 16 X 16



H.420 X L.150 mm.
Art. 01.173 □ 16 X 16



Martellato / Hammered
H.420 X L.150 mm.
Art. 01.174 □ 16 X 16



H.430 X L.205 mm.
Art. 01.175 □ 16 X 16



Martellato / Hammered
H.430 X L.205 mm.
Art. 01.176 □ 16 X 16



H.450 X L.180 mm.
Art. 01.177 □ 16 X 16



Martellato / Hammered
H.450 X L.180 mm.
Art. 01.178 □ 16 X 16



H.480 X L.140 mm.
Art. 01.179 □ 16 X 16



Martellato / Hammered
H.480 X L.140 mm.
Art. 01.180 □ 16 X 16



H.480 X L.160 mm.
Art. 01.181 □ 16 X 16



Martellato / Hammered
H.480 X L.160 mm.
Art. 01.182 □ 16 X 16

Tutte le parti di questo catalogo - foto comprese - sono di proprietà Euro-Fer. La riproduzione, anche parziale, è vietata in ogni forma e con ogni mezzo. / Every part of this catalogue - photos included - is Euro-Fer's property. All forms of copying are strictly prohibited.



Tutte le parti di questo catalogo - foto comprese - sono di proprietà Euro-Fer. La riproduzione, anche parziale, è vietata in ogni forma e con ogni mezzo. / Every part of this catalogue - photos included - is Euro-Fer's property. All forms of copying are strictly prohibited.

RR



H.660 X L.170 mm.
Art. 01.195 □ 16 X 16

RR



Martellato / Hammered
H.660 X L.170 mm.
Art. 01.196 □ 16 X 16

RR



H.670 X L.200 mm.
Art. 01.197 □ 16 X 16

RR



Martellato / Hammered
H.670 X L.200 mm.
Art. 01.198 □ 16 X 16

RR



H.700 X L.330 mm.
Art. 01.199 □ 16 X 16

RR



Martellato / Hammered
H.700 X L.330 mm.
Art. 01.200 □ 16 X 16

RR



H.920 X L.310 mm.
Art. 01.201 □ 16 X 16

RR



Martellato / Hammered
H.920 X L.310 mm.
Art. 01.202 □ 16 X 16

RR



H.920 X L.530 mm.
Art. 01.203 □ 16 X 16

RR



Martellato / Hammered
H.920 X L.530 mm.
Art. 01.204 □ 16 X 16

RR



H.1020 X L.360 mm.
Art. 01.205 □ 16 X 16

RR



Martellato / Hammered
H.1020 X L.360 mm.
Art. 01.206 □ 16 X 16



Tutte le parti di questo catalogo - foto comprese - sono di proprietà Euro-Fer. La riproduzione, anche parziale, è vietata in ogni forma e con ogni mezzo. / Every part of this catalogue - photos included - is Euro-Fer's property. All forms of copying are strictly prohibited.

RR



H.170 X L.100 mm.
Art. 01.207 □ 16 X 16

RR



Martellato / Hammered
H.170 X L.100 mm.
Art. 01.208 □ 16 X 16

RR



H.210 X L.115 mm.
Art. 01.209 □ 16 X 16

RR



Martellato / Hammered
H.210 X L.115 mm.
Art. 01.210 □ 16 X 16

RR



H.220 X L.170 mm.
Art. 01.211 □ 16 X 16

RR



Martellato / Hammered
H.220 X L.170 mm.
Art. 01.212 □ 16 X 16

RR



H.250 X L.180 mm.
Art. 01.213 □ 16 X 16

RR



Martellato / Hammered
H.250 X L.180 mm.
Art. 01.214 □ 16 X 16

RR



H.270 X L.190 mm.
Art. 01.215 □ 16 X 16

RR



Martellato / Hammered
H.270 X L.190 mm.
Art. 01.216 □ 16 X 16

RR



H.280 X L.150 mm.
Art. 01.217 □ 16 X 16

RR



Martellato / Hammered
H.280 X L.150 mm.
Art. 01.218 □ 16 X 16

RR



H.310 X L.200 mm.
Art. 01.219 □ 16 X 16

RR



Martellato / Hammered
H.310 X L.200 mm.
Art. 01.220 □ 16 X 16

RR



H.320 X L.210 mm.
Art. 01.221 □ 16 X 16

RR



Martellato / Hammered
H.320 X L.210 mm.
Art. 01.222 □ 16 X 16

RR



H.320 X L.205 mm.
Art. 01.223 □ 16 X 16

RR



H.320 X L.240 mm.
Art. 01.225 □ 16 X 16

RR



Martellato / Hammered
H.320 X L.240 mm.
Art. 01.226 □ 16 X 16

RR



H.350 X L.260 mm.
Art. 01.227 □ 16 X 16

RR



Martellato / Hammered
H.350 X L.260 mm.
Art. 01.228 □ 16 X 16

RR



H.350 X L.280 mm.
Art. 01.229 □ 16 X 16

RR



Martellato / Hammered
H.350 X L.280 mm.
Art. 01.230 □ 16 X 16

RR



H.420 X L.310 mm.
Art. 01.231 □ 16 X 16



Tutte le parti di questo catalogo - foto comprese - sono di proprietà Euro-Fer. La riproduzione, anche parziale, è vietata in ogni forma e con ogni mezzo. / Every part of this catalogue - photos included - is Euro-Fer's property. All forms of copying are strictly prohibited.

RR



H.450 X L.330 mm.
Art. 01.233 □ 16 X 16

RR



Martellato / Hammered
H.450 X L.330 mm.
Art. 01.234 □ 16 X 16

RR



H.480 X L.230 mm.
Art. 01.235 □ 16 X 16

RR



Martellato / Hammered
H.480 X L.230 mm.
Art. 01.236 □ 16 X 16

RR



H.510 X L.210 mm.
Art. 01.237 □ 16 X 16

RR



Martellato / Hammered
H.510 X L.210 mm.
Art. 01.238 □ 16 X 16

RR



H.540 X L.300 mm.
Art. 01.239 □ 16 X 16

RR



Martellato / Hammered
H.540 X L.300 mm.
Art. 01.240 □ 16 X 16

RR



H.580 X L.410 mm.
Art. 01.241 □ 16 X 16

RR



Martellato / Hammered
H.580 X L.410 mm.
Art. 01.242 □ 16 X 16

NC



H.200 X L.85 mm.
Art. 01.243 □ 10 X 10

NC



H.240 X L.110 mm.
Art. 01.244 □ 10 X 10

NC



H.250 X L.110 mm.
Art. 01.245 □ 10 X 10

NC



H.270 X L.135 mm.
Art. 01.246 □ 10 X 10

NC



H.350 X L.135 mm.
Art. 01.247 □ 10 X 10

NC



H.420 X L.150 mm.
Art. 01.248 □ 10 X 10

NC



H.470 X L.220 mm.
Art. 01.249 □ 10 X 10

NC



H.450 X L.135 mm.
Art. 01.250 □ 10 X 10

NC



H.330 X L.230 mm.
Art. 01.251 □ 10 X 10

NC



H.440 X L.290 mm.
Art. 01.252 □ 10 X 10

NC



H.540 X L.250 mm.
Art. 01.253 □ 10 X 10

NC



H.570 X L.350 mm.
Art. 01.254 □ 10 X 10

RR



Forgiato / Forged
H.360 X L.125 mm.
Art. 01.255 □ 14 X 14

RR



Forgiato / Forged
H.360 X L.125 mm.
Art. 01.256 □ 14 X 14

Tutte le parti di questo catalogo - foto comprese - sono di proprietà Euro-Fer. La riproduzione, anche parziale, è vietata in ogni forma e con ogni mezzo. / Every part of this catalogue - photos included - is Euro-Fer's property. All forms of copying are strictly prohibited.

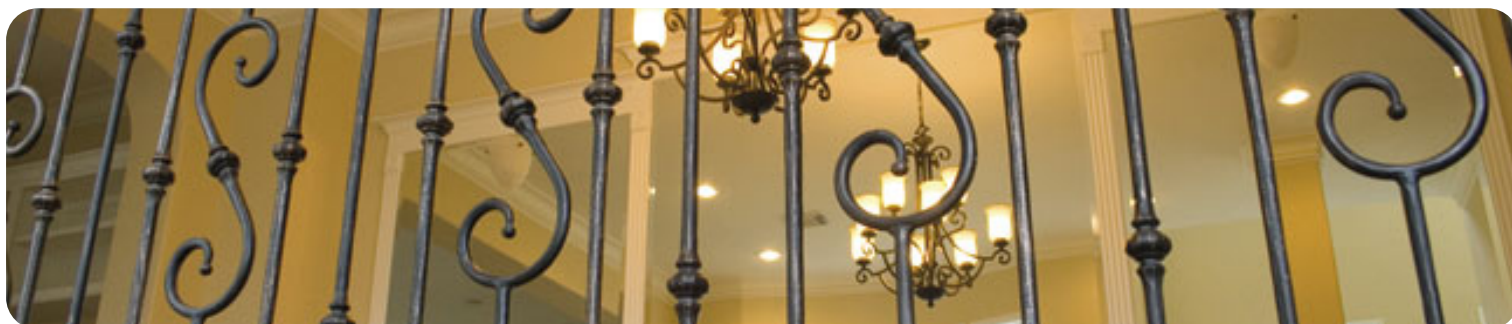
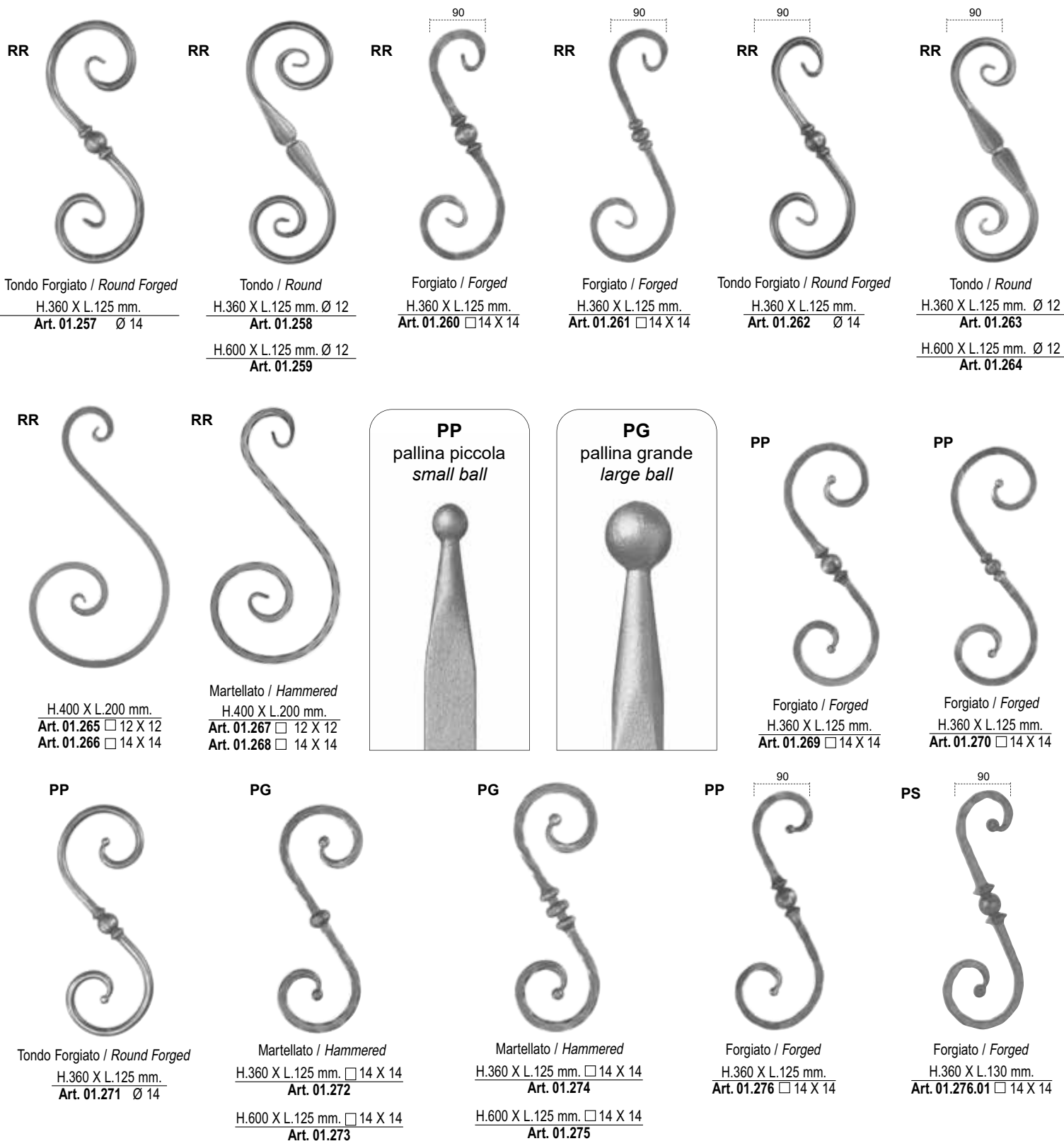

Tutte le parti di questo catalogo - foto comprese - sono di proprietà Euro-Fer. La riproduzione, anche parziale, è vietata in ogni forma e con ogni mezzo. / Every part of this catalogue - photos included - is Euro-Fer's property. All forms of copying are strictly prohibited.



PP
Forgiato / Forged
H.360 X L.125 mm.
Art. 01.277 □ 14 X 14



PP
Tondo Forgiato / Round Forged
H.360 X L.125 mm.
Art. 01.278 Ø 14



PG
Martellato / Hammered
H.360 X L.125 mm.
Art. 01.279 □ 14 X 14



PG
Martellato / Hammered
H.360 X L.125 mm.
Art. 01.281 □ 14 X 14



PG
Martellato / Hammered □ 12 X 12
Art. 01.283 H.360 X L.125 mm.
Art. 01.284 H.600 X L.125 mm

H.600 X L.125 mm.
Art. 01.280 □ 14 X 14

H.600 X L.125 mm.
Art. 01.282 □ 14 X 14

Martellato / Hammered □ 14 X 14
Art. 01.285 H.360 X L.125 mm
Art. 01.286 H.600 X L.125 mm



PG
□ 12 X 12
Art. 01.287 H.360 X L.125 mm.
Art. 01.288 H.600 X L.125 mm
□ 14 X 14
Art. 01.289 H.360 X L.125 mm
Art. 01.290 H.600 X L.125 mm



PG
Martellato / Hammered
H.250 X L.150 mm.
Art. 01.291 □ 12 X 12
Art. 01.292 □ 14 X 14



CR
Mod. Scala / Scala Model
H.115 X L.75 mm.
Art. 01.293 □ 8 X 8



CR
Modello Scala / Scala Model
H.180 X L.90 mm.
Art. 01.294 ≡ 12 X 6
Art. 01.295 ≡ 14 X 6
Art. 01.295.01 ≡ 16 X 6



CR
Modello Scala / Scala Model
H.280 X L.125 mm.
Art. 01.296 ≡ 12 X 6
Art. 01.297 ≡ 14 X 6
Art. 01.297.01 ≡ 16 X 6



CR
Modello Scala / Scala Model
H.350 X L.135 mm.
Art. 01.298 ≡ 12 X 6
Art. 01.299 ≡ 14 X 6
Art. 01.299.01 ≡ 16 X 6



CR
Modello Scala / Scala Model
H.450 X L.145 mm.
Art. 01.300 ≡ 12 X 6
Art. 01.301 ≡ 14 X 6
Art. 01.301.01 ≡ 16 X 6



CR
H.280 X L.125 mm.
Art. 01.302 ≡ 12 X 6
Art. 01.303 ≡ 14 X 6
Art. 01.303.01 ≡ 16 X 6



CR
H.350 X L.135 mm.
Art. 01.304 ≡ 12 X 6
Art. 01.305 ≡ 14 X 6
Art. 01.305.01 ≡ 16 X 6



CR
H.450 X L.145 mm.
Art. 01.306 ≡ 12 X 6
Art. 01.307 ≡ 14 X 6
Art. 01.307.01 ≡ 16 X 6

Tutte le parti di questo catalogo - foto comprese - sono di proprietà Euro-Fer. La riproduzione, anche parziale, è vietata in ogni forma e con ogni mezzo. / Every part of this catalogue - photos included - is Euro-Fer's property. All forms of copying are strictly prohibited.

CR



H.125 X L.80 mm.

Art. 01.308 ≙ 12 X 6
Art. 01.309 ≙ 14 X 6

CR



H.145 X L.70 mm.

Art. 01.310 ≙ 12 X 6
Art. 01.311 ≙ 14 X 6

CR



H.250 X L.130 mm.

Art. 01.312 ≙ 12 X 6
Art. 01.313 ≙ 14 X 6

CR



Tondo / Round

H.290 X L.115 mm.
Art. 01.314 Ø 12
Art. 01.314.01 Ø 14

CR



Tondo / Round

H.350 X L.125 mm.
Art. 01.315 Ø 12
Art. 01.315.01 Ø 14

CR



Tondo / Round

H.500 X L.100 mm.
Art. 01.321 Ø 12
Art. 01.321.01 Ø 14

CR



Tondo / Round

H.390 X L.130 mm.
Art. 01.316 Ø 12
Art. 01.316.01 Ø 14

CR



Tondo / Round

H.450 X L.130 mm.
Art. 01.317 Ø 12
Art. 01.317.01 Ø 14

CR



Tondo / Round

H.180 X L.105 mm.
Art. 01.318 Ø 12
Art. 01.318.01 Ø 14

CR



Tondo / Round

H.220 X L.110 mm.
Art. 01.319 Ø 12
Art. 01.319.01 Ø 14

CR



Tondo / Round

H.190 X L.105 mm.
Art. 01.320 Ø 12
Art. 01.320.01 Ø 14

CR

Tondo Martellato
Hammered RoundH.290 X L.115 mm.
Art. 01.322 Ø 12
Art. 01.322.01 Ø 14

CR

Tondo Martellato
Hammered RoundH.350 X L.125 mm.
Art. 01.323 Ø 12
Art. 01.323.01 Ø 14

CR

Tondo Martellato
Hammered RoundH.390 X L.130 mm.
Art. 01.324 Ø 12
Art. 01.324.01 Ø 14

CR

Tondo Martellato
Hammered RoundH.450 X L.130 mm.
Art. 01.325 Ø 12
Art. 01.325.01 Ø 14

CR

Tondo Martellato
Hammered RoundH.180 X L.105 mm.
Art. 01.326 Ø 12
Art. 01.326.01 Ø 14

CR

Tondo Martellato
Hammered RoundH.220 X L.110 mm.
Art. 01.327 Ø 12
Art. 01.327.01 Ø 14

CR

Tondo Martellato
Hammered RoundH.190 X L.105 mm.
Art. 01.328 Ø 12
Art. 01.328.01 Ø 14

CR

Tondo Martellato
Hammered RoundH.500 X L.100 mm.
Art. 01.329 Ø 12

RR



Martellato / Hammered

H.380 X L.200 mm.
Art. 01.330 ≙ 25 X 6

RR



Martellato / Hammered

H.470 X L.270 mm.
Art. 01.331 ≙ 25 X 6

RR



Martellato / Hammered

H.640 X L.130 mm.
Art. 01.332 ≙ 25 X 6

RR



Martellato / Hammered

H.300 X L.150 mm.
Art. 01.333 ≙ 25 X 6

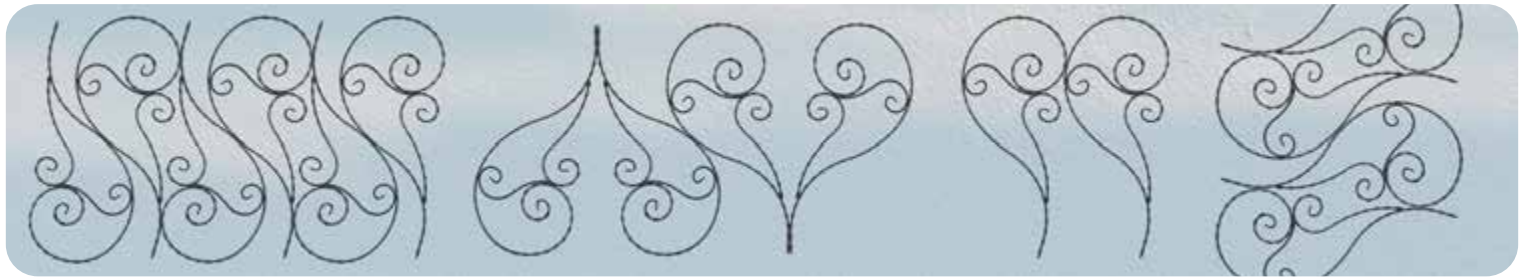

RR
Martellato / *Hammered*
H.710 X L.305 mm.
Art. 01.334 ≡ 25 X 6



RR
Martellato / *Hammered*
H.700 X L.300 mm.
Art. 01.335 ≡ 25 X 6



PG
Martellato / *Hammered*
H.170 X L.115 mm.
Art. 01.336 □ 12 X 12
Art. 01.337 □ 14 X 14

Liscio / *Smooth*
H.170 X L.115 mm.
Art. 01.338 □ 12 X 12
Art. 01.339 □ 14 X 14



RR
Tondo / *Round*
H.200 X L.135 mm.
Art. 01.340 Ø 12
Art. 01.341 Ø 14
Art. 01.342 Ø 16



RR
Liscio / *Smooth*
H.200 X L.135 mm.
Art. 01.343 □ 12 X 12
Art. 01.344 □ 14 X 14
Art. 01.345 □ 16 X 16



RR
Martellato / *Hammered*
H.360 X L.130 mm.
Art. 01.349 □ 12 X 12
Art. 01.350 □ 14 X 14



PG
Tondo / *Round*
H.350 X L.150 mm.
Art. 01.353 Ø 12
Art. 01.354 Ø 14
Art. 01.355 Ø 16



RR
Liscio / *Smooth*
H.350 X L.150 mm.
Art. 01.356 □ 12 X 12
Art. 01.357 □ 14 X 14
Art. 01.358 □ 16 X 16

Martellato / *Hammered*
H.350 X L.150 mm.
Art. 01.359 □ 12 X 12
Art. 01.360 □ 14 X 14
Art. 01.361 □ 16 X 16



PG
Liscio / *Smooth*
H.350 X L.150 mm.
Art. 01.362 □ 12 X 12
Art. 01.363 □ 14 X 14
Art. 01.364 □ 16 X 16

Martellato / *Hammered*
H.350 X L.150 mm.
Art. 01.365 □ 12 X 12
Art. 01.366 □ 14 X 14
Art. 01.367 □ 16 X 16



PG
Tondo / *Round*
H.350 X L.150 mm.
Art. 01.368 Ø 12
Art. 01.369 Ø 14
Art. 01.370 Ø 16

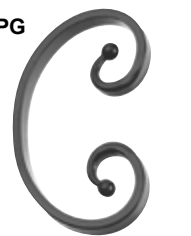

PG
Liscio / *Smooth*
H.135 X L.80 mm.
Art. 01.371 ≡ 14 X 6



PG
Liscio / *Smooth*
H.145 X L.90 mm.
Art. 01.372 Ø 10
Art. 01.372.01 Ø 12



PG
Liscio / *Smooth*
H.290 X L.120 mm.
Art. 01.373 ≡ 14 X 6



RR
Mod. Scala / *Scala model*
H.290 X L.120 mm.
Art. 01.374 ≡ 14 X 6



PG
Liscio / *Smooth*
H.220 X L.110 mm.
Art. 01.375 ≡ 14 X 6



PG
Liscio / *Smooth*
H.200 X L.100 mm.
Art. 01.376 ≡ 14 X 6
Art. 01.376.02 ≡ 16 X 8



PG
Liscio / *Smooth*
H.250 X L.75 mm.
Art. 01.377 ≡ 14 X 6

Tutte le parti di questo catalogo - foto comprese - sono di proprietà Euro-Fer. La riproduzione, anche parziale, è vietata in ogni forma e con ogni mezzo. / Every part of this catalogue - photos included - is Euro-Fer's property. All forms of copying are strictly prohibited.

PS
pallina "a sole"
sun ball



PS



Liscio / Smooth
H.135 X L.80 mm.
Art. 01.400 ≙ 14 X 6

PS



Liscio / Smooth
H.190 X L.65 mm.
Art. 01.401 □ 8 X 8



PS



Liscio / Smooth
H.200 X L.100 mm.
Art. 01.402 ≙ 14 X 6



PS



Liscio / Smooth
H.220 X L.110 mm.
Art. 01.403 ≙ 14 X 6

PS



Liscio / Smooth
H.360 X L.125 mm.
Art. 01.404 □ 12 X 12
Art. 01.404.01 □ 14 X 14
Art. 01.404.02 □ 16 X 16

PS



Liscio / Smooth
H.350 X L.150 mm.
Art. 01.405 □ 12 X 12
Art. 01.405.01 □ 14 X 14
Art. 01.405.02 □ 16 X 16

PS



Liscio / Smooth
H.350 X L.150 mm.
Art. 01.406 Ø 12
Art. 01.406.01 Ø 14

PS



Liscio / Smooth
H.420 X L.220 mm.
Art. 01.407 Ø 10
Art. 01.407.01 Ø 12
Art. 01.407.02 Ø 14

PS



Liscio / Smooth
H.550 X L.125 mm.
Art. 01.408 Ø 10
Art. 01.408.01 Ø 12
Art. 01.408.02 Ø 14
Art. 01.408.03 Ø 16

PS



Liscio / Smooth
H.250 X L.75 mm.
Art. 01.409 ≙ 14 X 6



RR



Rigato -Martellato-Attorcigliato
Fluted-Hammered and Twisted
H.800 X L.220 mm.
Art. 01.450 □ 14 X 14



RR



Rigato -Martellato-Attorcigliato
Fluted-Hammered and Twisted
H.500 X L.145 mm.
Art. 01.451 □ 14 X 14



RR



Rigato -Martellato-Attorcigliato
Fluted-Hammered and Twisted
H.330 X L.130 mm.
Art. 01.452 □ 14 X 14



CS
chiocciola schiacciata
pressed spiral

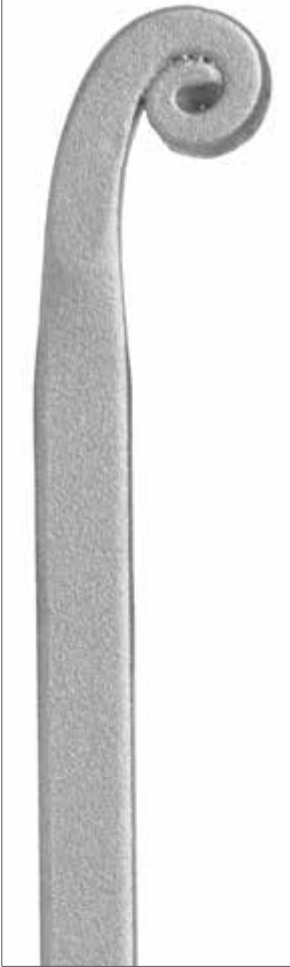

Liscio / Smooth
H.200 x L.125 mm
Art. 01.490 Ø 14
Art. 01.491 Ø 16
Art. 01.492 Ø 18
Art. 01.493 Ø 20

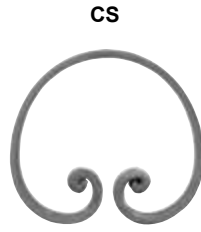

Liscio / Smooth
H.160 x L.175 mm
Art. 01.500 □ 12X12
Art. 01.501 ≧ 16x8
Art. 01.502 ≧ 20x10
Art. 01.503 Ø 10



Liscio / Smooth
H.155 X L.95 mm.
Art. 01.504 □ 12 X 12
Art. 01.505 ≧ 16 X 8
Art. 01.506 ≧ 20 X 10
Art. 01.507 Ø 10



Liscio / Smooth
H.270 X L.85 mm.
Art. 01.508 □ 12 X 12
Art. 01.509 ≧ 16 X 8
Art. 01.510 ≧ 20 X 10
Art. 01.511 Ø 10



Liscio / Smooth
H.180 X L.90 mm.
Art. 01.512 □ 12 X 12
Art. 01.513 ≧ 16 X 8
Art. 01.514 ≧ 20 X 10
Art. 01.515 Ø 10



Liscio / Smooth
H.290 X L.115 mm.
Art. 01.516 □ 12 X 12
Art. 01.517 ≧ 16 X 8
Art. 01.518 ≧ 20 X 10
Art. 01.519 Ø 10



Liscio / Smooth
H.350 x L.110 mm
Art. 01.519.10 □ 16 X16



Liscio / Smooth
H.420 x L.165 mm
Art. 01.519.15 □ 16 X16



Liscio / Smooth
H.120 X L.70 mm.
Art. 01.520 Ø 10



Liscio / Smooth
H.140 X L.70 mm.
Art. 01.521 Ø 10



Liscio / Smooth
H.140 X L.80 mm.
Art. 01.522 Ø 10



Liscio / Smooth
H.210 x L.140 mm
Art. 01.522.05 Ø 10
Art. 01.522.06 □ 12
Art. 01.522.07 ≧ 16 x 8
Art. 01.522.08 ≧ 20 x 10



Liscio / Smooth
H.410 x L.270 mm
Art. 01.522.10 Ø 10
Art. 01.522.11 □ 12
Art. 01.522.12 ≧ 20 x 10
Art. 01.522.13 ≧ 16 x 8



RR



Liscio / Smooth
H.294 x L.100 mm

Art. 01.523 ≙ 14 X 6

Art. 01.523.01 ≙ 16 X 6

Art. 01.523.02 ≙ 16 X 8 **NEW**



RR



Mod. Scala / Scala Model
H.294 x L.100 mm

Art. 01.524 ≙ 14 X 6

Art. 01.524.01 ≙ 16 X 6

Art. 01.524.02 ≙ 16 X 8 **NEW**

RR



Liscio / Smooth
H.200 x L.200 mm
Art. 01.525 ≙ 12 x 6



Liscio / Smooth
H.120 x L.100 mm
Art. 01.526 ≙ 12 x 6
H.125 x L.100 mm
Art. 01.527 □ 12

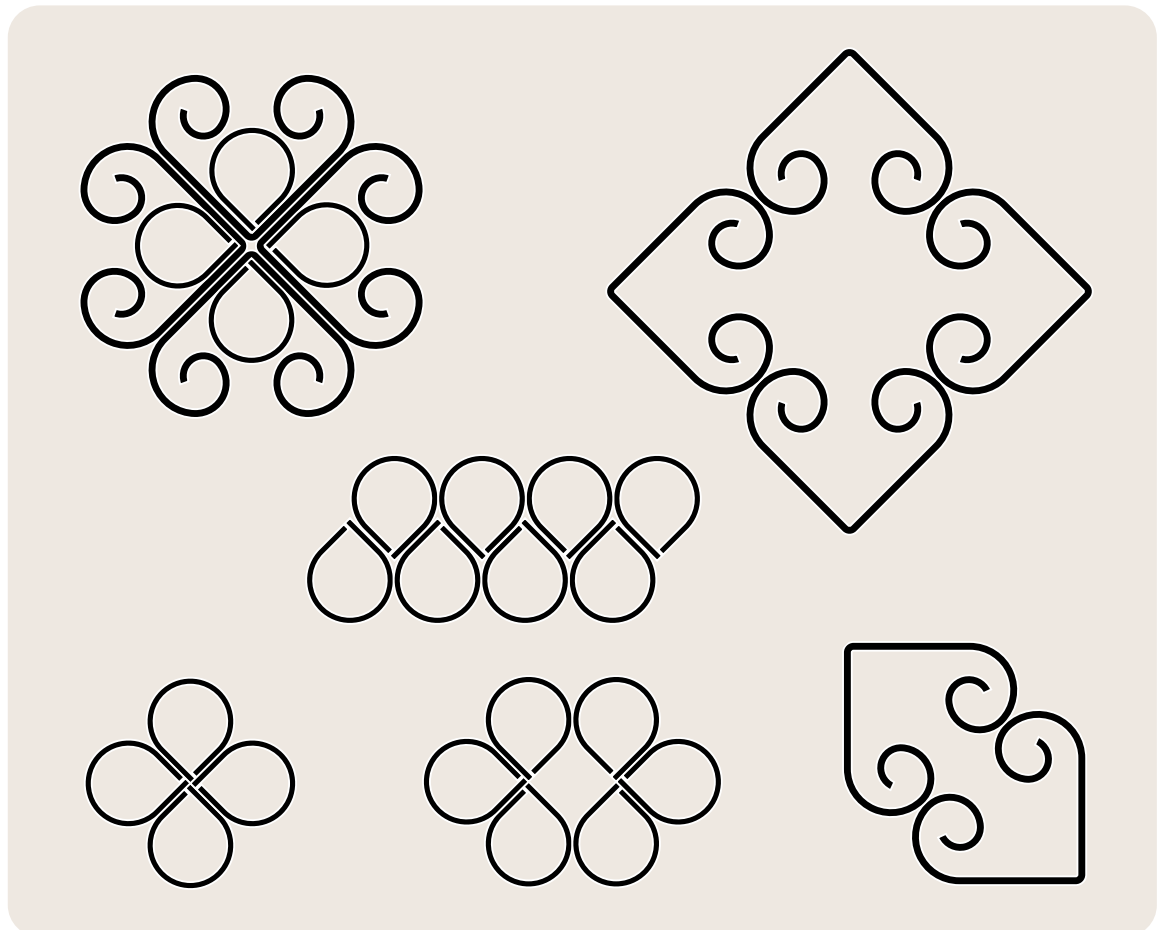

RR



Liscio / Smooth
H.750 X L.260 mm.
Art. 01.528 ≙ 30 X 8

TA



H.500 X L.100 mm.
Art. 01.529 ≙ 12 X 3

RR



H.650 X L.170 mm.
Art. 01.530 ≙ 16 X 6

RR



H.780 X L.280 mm.
Art. 01.531 Ø 25



Tutte le parti di questo catalogo - foto comprese - sono di proprietà Euro-Fer. La riproduzione, anche parziale, è vietata in ogni forma e con ogni mezzo. / Every part of this catalogue - photos included - is Euro-Fer's property. All forms of copying are strictly prohibited.

N.B. Tutti i cerchi non sono saldati
 NOTE: All the circles are not welded.

H: Diametro esterno / External diameter

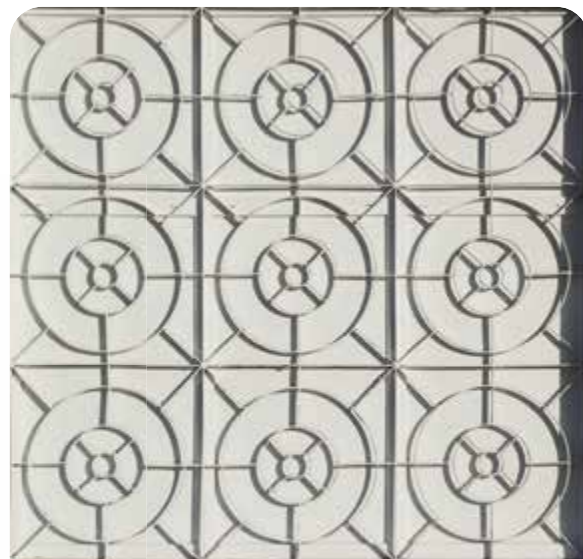

Cerchi con sezione in tondo e tondo martellato
 Round section circles and hammered circles

Ø 8 mm.		Ø 12 mm.		Ø 14 mm.		Ø 16 mm.	
Art. 02.001	H 100 mm.	Art. 02.006.50	H 115 mm.	Art. 02.009.08	H 100 mm.	Art. 02.009.19	H 100 mm.
Art. 02.002	H 120 mm.	Art. 02.007	H 100 mm.	Art. 02.009.09	H 110 mm.	Art. 02.009.20	H 110 mm.
Art. 02.003	H 130 mm.	Art. 02.008	H 120 mm.	Art. 02.009.10	H 115 mm.	Art. 02.009.21	H 120 mm.
Art. 02.003.01	H 90 mm.	Art. 02.009	H 130 mm.	Art. 02.009.11	H 120 mm.	Art. 02.009.22	H 135 mm.
Art. 02.003.02	H 105 mm.	Art. 02.009.01	H 110 mm.	Art. 02.009.12	H 125 mm.	Art. 02.009.23	H 140 mm.
Art. 02.003.03	H 110 mm.	Art. 02.009.02	H 135 mm.	Art. 02.009.13	H 130 mm.	Art. 02.009.24	H 180 mm.
Art. 02.003.04	H 135 mm.	Art. 02.009.03	H 140 mm.	Art. 02.009.14	H 135 mm.	Art. 02.009.25	H 250 mm.
Art. 02.003.05	H 180 mm.	Art. 02.009.04	H 180 mm.	Art. 02.009.15	H 140 mm.	Mart. a caldo / Hot hammered Ø 16 mm.	
Art. 02.003.06	H 250 mm.	Art. 02.009.05	H 210 mm.	Art. 02.009.16	H 160 mm.		
Art. 02.003.07	H 270 mm.	Art. 02.009.06	H 250 mm.	Art. 02.009.17	H 180 mm.	Art. 02.009.37	H 100 mm.
Ø 10 mm.		Mart. a caldo / Hot hammered Ø 12 mm.		Mart. a caldo / Hot hammered Ø 14 mm.		Art. 02.009.38	H 110 mm.
Art. 02.004	H 100 mm.	Art. 02.007.01	H 100 mm.	Art. 02.009.26	H 100 mm.	Art. 02.009.39	H 120 mm.
Art. 02.005	H 120 mm.	Art. 02.007.02	H 110 mm.	Art. 02.009.27	H 110 mm.	Art. 02.009.40	H 135 mm.
Art. 02.006	H 130 mm.	Art. 02.007.03	H 120 mm.	Art. 02.009.28	H 115 mm.	Art. 02.009.41	H 140 mm.
Art. 02.006.01	H 90 mm.	Art. 02.007.04	H 130 mm.	Art. 02.009.29	H 120 mm.	Art. 02.009.42	H 180 mm.
Art. 02.006.02	H 110 mm.	Art. 02.007.05	H 135 mm.	Art. 02.009.30	H 125 mm.	Art. 02.009.43	H 250 mm.
Art. 02.006.03	H 135 mm.	Art. 02.007.06	H 140 mm.	Art. 02.009.31	H 130 mm.		
Art. 02.006.04	H 140 mm.	Art. 02.007.07	H 180 mm.	Art. 02.009.32	H 135 mm.		
Art. 02.006.05	H 180 mm.	Art. 02.007.08	H 210 mm.	Art. 02.009.33	H 140 mm.		
Art. 02.006.06	H 250 mm.	Art. 02.007.09	H 250 mm.	Art. 02.009.34	H 160 mm.		
Art. 02.006.07	H 270 mm.	Art. 02.007.10	H 275 mm.	Art. 02.009.35	H 180 mm.		
				Art. 02.009.36	H 250 mm.		



Cerchi con sezione in quadro
Square section circles

□ 8 X 8 mm.	
Art. 02.010	H 100 mm.
Art. 02.011	H 120 mm.
Art. 02.012	H 130 mm.
Art. 02.012.01	H 90 mm.
Art. 02.012.02	H 105 mm.
Art. 02.012.03	H 110 mm.
Art. 02.012.04	H 135 mm.
Art. 02.012.05	H 180 mm.
Art. 02.012.06	H 250 mm.
Art. 02.012.07	H 270 mm.

□ 12 X 12 mm.	
Art. 02.016	H 100 mm.
Art. 02.017	H 120 mm.
Art. 02.018	H 130 mm.
Art. 02.018.01	H 110 mm.
Art. 02.018.02	H 135 mm.
Art. 02.018.03	H 140 mm.
Art. 02.018.04	H 180 mm.
Art. 02.018.05	H 210 mm.
Art. 02.018.06	H 250 mm.
Art. 02.018.07	H 275 mm.

□ 16 X 16 mm.	
Art. 02.018.19	H 100 mm.
Art. 02.018.20	H 110 mm.
Art. 02.018.21	H 120 mm.
Art. 02.018.22	H 135 mm.
Art. 02.018.23	H 140 mm.
Art. 02.018.24	H 180 mm.
Art. 02.018.25	H 250 mm.

□ 10 X 10 mm.	
Art. 02.013	H 100 mm.
Art. 02.014	H 120 mm.
Art. 02.015	H 130 mm.
Art. 02.015.01	H 90 mm.
Art. 02.015.02	H 110 mm.
Art. 02.015.03	H 135 mm.
Art. 02.015.04	H 140 mm.
Art. 02.015.05	H 180 mm.
Art. 02.015.06	H 250 mm.
Art. 02.015.07	H 270 mm.

□ 14 X 14 mm.	
Art. 02.018.08	H 100 mm.
Art. 02.018.09	H 110 mm.
Art. 02.018.10	H 115 mm.
Art. 02.018.11	H 120 mm.
Art. 02.018.12	H 125 mm.
Art. 02.018.13	H 130 mm.
Art. 02.018.14	H 135 mm.
Art. 02.018.15	H 140 mm.
Art. 02.018.16	H 160 mm.
Art. 02.018.17	H 180 mm.
Art. 02.018.18	H 250 mm.

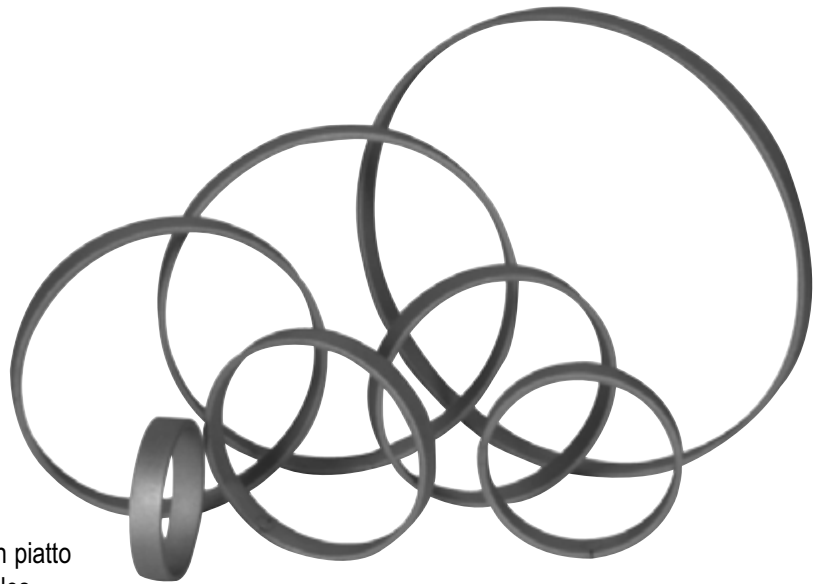

Cerchi con sezione in piatto
Flat section circles

≠ 16 X 4 mm.	
Art. 02.019	H 100 mm.
Art. 02.020	H 120 mm.
Art. 02.021	H 130 mm.
Art. 02.022	H 160 mm.
Art. 02.023	H 190 mm.
Art. 02.024	H 250 mm.
Art. 02.024.01	H 110 mm.
Art. 02.024.02	H 125 mm.
Art. 02.024.03	H 175 mm.
Art. 02.024.04	H 200 mm.
Art. 02.024.05	H 300 mm.

≠ 30 X 4 mm.	
Art. 02.030.06	H 100 mm.
Art. 02.030.07	H 110 mm.
Art. 02.030.08	H 120 mm.
Art. 02.030.09	H 125 mm.
Art. 02.030.10	H 130 mm.
Art. 02.030.11	H 160 mm.
Art. 02.030.12	H 190 mm.
Art. 02.030.13	H 250 mm.

≠ 14 X 6 mm.	
Art. 02.036	H 100 mm.
Art. 02.037	H 120 mm.
Art. 02.038	H 130 mm.
Art. 02.039	H 160 mm.
Art. 02.040	H 190 mm.
Art. 02.041	H 250 mm.
Art. 02.041.01	H 80 mm.
Art. 02.041.02	H 90 mm.
Art. 02.041.03	H 105 mm.
Art. 02.041.04	H 110 mm.
Art. 02.041.05	H 115 mm.
Art. 02.041.06	H 125 mm.
Art. 02.041.07	H 128 mm.
Art. 02.041.08	H 150 mm.

≠ 16 X 8 mm.	
Art. 02.042	H 100 mm.
Art. 02.043	H 120 mm.
Art. 02.043.01	H 110 mm.
Art. 02.043.02	H 128 mm.
Art. 02.043.03	H 130 mm.
Art. 02.043.04	H 180 mm.

≠ 20 X 4 mm.	
Art. 02.025	H 100 mm.
Art. 02.026	H 120 mm.
Art. 02.027	H 130 mm.
Art. 02.028	H 160 mm.
Art. 02.029	H 190 mm.
Art. 02.030	H 250 mm.
Art. 02.030.01	H 110 mm.
Art. 02.030.02	H 125 mm.
Art. 02.030.03	H 175 mm.
Art. 02.030.04	H 200 mm.
Art. 02.030.05	H 300 mm.

≠ 12 X 6 mm.	
Art. 02.031	H 100 mm.
Art. 02.032	H 120 mm.
Art. 02.033	H 130 mm.
Art. 02.034	H 160 mm.
Art. 02.035	H 190 mm.
Art. 02.035.01	H 80 mm.
Art. 02.035.02	H 90 mm.
Art. 02.035.03	H 105 mm.
Art. 02.035.04	H 110 mm.
Art. 02.035.05	H 115 mm.
Art. 02.035.06	H 125 mm.
Art. 02.035.07	H 128 mm.
Art. 02.035.08	H 150 mm.
Art. 02.035.09	H 250 mm.

≠ 20 X 6 mm.	
Art. 02.041.09	H 80 mm.
Art. 02.041.10	H 90 mm.
Art. 02.041.11	H 100 mm.
Art. 02.041.12	H 105 mm.
Art. 02.041.13	H 110 mm.
Art. 02.041.14	H 115 mm.
Art. 02.041.15	H 120 mm.
Art. 02.041.16	H 125 mm.
Art. 02.041.17	H 128 mm.
Art. 02.041.18	H 130 mm.
Art. 02.041.19	H 150 mm.
Art. 02.041.20	H 160 mm.
Art. 02.041.21	H 190 mm.
Art. 02.041.22	H 250 mm.

≠ 16 X 6 mm.	
Art. 02.043.29	H 80 mm.
Art. 02.043.30	H 90 mm.
Art. 02.043.31	H 100 mm.
Art. 02.043.32	H 105 mm.
Art. 02.043.33	H 110 mm.
Art. 02.043.34	H 115 mm.
Art. 02.043.35	H 120 mm.
Art. 02.043.36	H 125 mm.
Art. 02.043.37	H 128 mm.
Art. 02.043.38	H 130 mm.
Art. 02.043.39	H 150 mm.
Art. 02.043.40	H 160 mm.
Art. 02.043.41	H 190 mm.
Art. 02.043.42	H 250 mm.



Cerchio aperto sezione in piatto
Open circle flat section

$\neq 12 \times 6$ mm.		$\neq 20 \times 6$ mm.	
Art. 02.043.05	H 100 mm.	Art. 02.043.15	H 100 mm.
Art. 02.043.06	H 110 mm.	Art. 02.043.16	H 110 mm.
Art. 02.043.07	H 120 mm.	Art. 02.043.17	H 120 mm.
Art. 02.043.08	H 130 mm.	Art. 02.043.18	H 130 mm.
Art. 02.043.09	H 150 mm.	Art. 02.043.19	H 150 mm.
$\neq 14 \times 6$ mm.		$\neq 16 \times 8$ mm.	
Art. 02.043.10	H 100 mm.	Art. 02.043.20	H 100 mm.
Art. 02.043.11	H 110 mm.	Art. 02.043.21	H 110 mm.
Art. 02.043.12	H 120 mm.	Art. 02.043.22	H 120 mm.
Art. 02.043.13	H 130 mm.	Art. 02.043.23	H 130 mm.
Art. 02.043.14	H 150 mm.	$\neq 16 \times 6$ mm.	
		Art. 02.043.43	H 100 mm.
		Art. 02.043.44	H 110 mm.
		Art. 02.043.45	H 120 mm.
		Art. 02.043.46	H 130 mm.
		Art. 02.043.47	H 150 mm.



Cerchio aperto sez. in quadro
Open circle square section

$\square 12 \times 12$ mm.	
Art. 02.043.24	H 100 mm.
Art. 02.043.25	H 110 mm.
Art. 02.043.26	H 120 mm.
Art. 02.043.27	H 130 mm.
Art. 02.043.28	H 180 mm.

Estremità battute e rastremate a caldo
Heat forged and tapered ends

H 100 mm	$\neq 12 \times 6$ mm
Art. 02.043.100	

H.200 X L.125 mm.
Art. 02.044 $\neq 12 \times 6$

H.160 X L.100 mm.
Art. 02.045 $\neq 16 \times 8$
Art. 02.045.01 $\neq 12 \times 6$
Art. 02.045.02 $\neq 14 \times 6$

H.140 X L.100 mm.
Art. 02.046 $\neq 16 \times 8$

H.190 X L.130 mm.
Art. 02.047 $\neq 20 \times 4$

H.160 X L.120 mm.
Art. 02.048 $\neq 16 \times 8$

Ovale Piatto Modello Scala Scala Model Flat Oval H.160 X L.100 mm.
Art. 02.048.01 $\neq 12 \times 6$
Art. 02.048.02 $\neq 14 \times 6$
Art. 02.048.03 $\neq 16 \times 6$



H.240 X L.170 mm.
Art. 02.049 $\square 14 \times 14$



H.160 X L.115 mm.
Art. 02.050 $\square 12 \times 12$



NEW



NEW



H.100 X L.100 mm.
Art. 02.050.50 ≙ 14 x 6

H.110 X L.110 mm.
Art. 02.050.51 ≙ 12 x 6

H.110 X L.110 mm.
Art. 02.050.55 ≙ 12 x 6

H.200 X L.200 mm.
Art. 02.051 □ 8 X 8
Art. 02.052 □ 10 X 10
Art. 02.053 □ 12 X 12

H.80 X L.80 mm.
Art. 02.050.54 ≙ 12 x 6

NEW



H.220 X L.220 mm.
Art. 02.050.56 ≙ 12 x 6

NEW

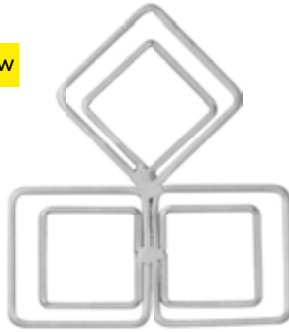

H.250 X L.220 mm.
Art. 02.050.60 ≙ 12 x 6



H.245 X L.190 mm.
Art. 02.054 □ 14 x 14

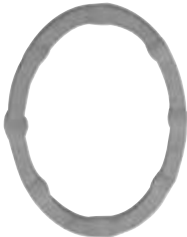

H.165 X L.120 mm.
Art. 02.055 □ 12 X 12



H.250 X L.175 mm.
Art. 02.056 □ 14 X 14



Mod. Scala / Scala Model
H.235 X L.125 mm.
Art. 02.057 ≙ 12 X 6
Art. 02.058 ≙ 14 X 6



H.250
Art. 02.059 ≙ 12 X 6
Art. 02.060 ≙ 14 X 6
Art. 02.061 ≙ 20 X 5



Mod. Scala / Scala Model
H.300 X L.110 mm.
Art. 02.062 ≙ 12 X 6
Art. 02.063 ≙ 14 X 6

Estremità battute e rastremate a caldo
Heat forged and tapered ends



H.50 X L.50 mm.
Art. 02.063.01 □ 4 X 4 - 6 Traf. / Elem.
Art. 02.063.02 □ 4 X 4 - 4 Traf. / Elem.



H.70 X L.70 mm.
Art. 02.063.03 □ 6 X 6 - 6 Traf. / Elem.
Art. 02.063.04 □ 6 X 6 - 4 Traf. / Elem.



H.70 X L.70 mm.
Art. 02.063.05 Ø 6 - 6 Traf. / Elem.

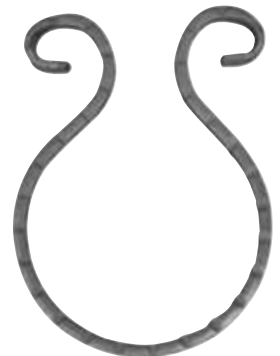

Mod. Scala / Scala Model
H.160 X L.110 mm.
Art. 02.064 ≙ 12 X 6
Art. 02.065 ≙ 14 X 6



Piatto Modello Scala
Flat Scala Model

Foro Ø 14 mm
Hole Ø 14 mm

Tondo Lavorato
Worked Round Bar

≠ 12 X 6 mm.
Art. 02.065.01 H 100 mm.
Art. 02.065.02 H 120 mm

≠ 12 X 6 mm.
Art. 02.065.07 H 100 mm.
Art. 02.065.08 H 120 mm

Ø 14 mm.
Art. 02.065.13 H 110 mm.
Art. 02.065.14 H 125 mm

Ø 14 mm.
Art. 02.065.15 H 100 mm.
Art. 02.065.16 H 110 mm.
Art. 02.065.17 H 120 mm.

≠ 14 X 6 mm.
Art. 02.065.03 H 100 mm.
Art. 02.065.04 H 120 mm.

≠ 14 X 6 mm.
Art. 02.065.09 H 100 mm.
Art. 02.065.10 H 120 mm.

≠ 16 X 6 mm.
Art. 02.065.05 H 100 mm.
Art. 02.065.06 H 120 mm.

≠ 16 X 6 mm.
Art. 02.065.11 H 100 mm.
Art. 02.065.12 H 120 mm.

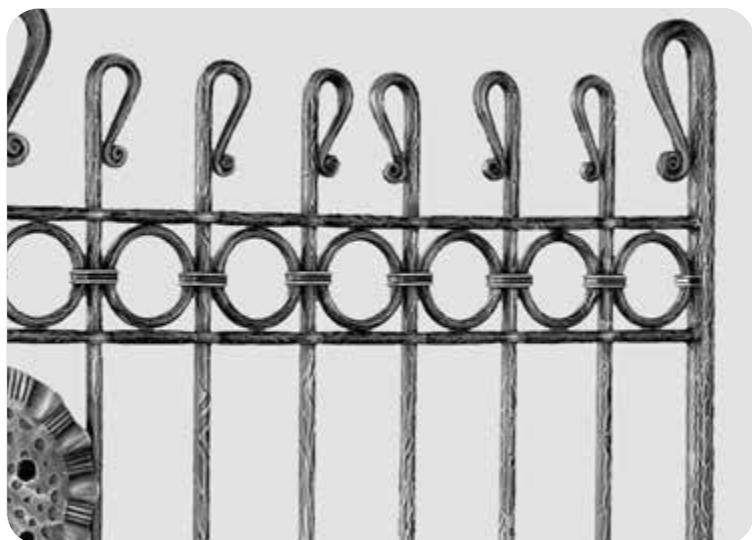



Piatto Modello Scala
Flat Scala Model



Piatto Modello Scala
Flat Scala Model



Martellato
Hammered

≠ 12 X 6 mm.

Art. 02.066	H 100 mm.
Art. 02.066.01	H 110 mm.
Art. 02.067	H 120 mm.
Art. 02.068	H 130 mm.
Art. 02.068.01	H 150 mm.

≠ 14 X 6 mm.

Art. 02.069	H 100 mm.
Art. 02.069.01	H 110 mm.
Art. 02.070	H 120 mm.
Art. 02.071	H 130 mm.
Art. 02.071.01	H 150 mm.

≠ 20 X 6 mm.

Art. 02.071.02	H 100 mm.
Art. 02.071.03	H 110 mm.
Art. 02.071.04	H 120 mm.
Art. 02.071.05	H 130 mm.
Art. 02.071.06	H 150 mm.

≠ 12 X 6 mm.

Art. 02.072	H 100 mm.
Art. 02.073	H 120 mm.
Art. 02.074	H 130 mm.
Art. 02.074.01	H 80 mm.
Art. 02.074.02	H 90 mm.
Art. 02.074.03	H 105 mm.
Art. 02.074.04	H 110 mm.
Art. 02.074.05	H 115 mm.
Art. 02.074.06	H 125 mm.
Art. 02.074.07	H 150 mm.
Art. 02.074.08	H 250 mm.

≠ 14 X 6 mm.

Art. 02.075	H 100 mm.
Art. 02.076	H 120 mm.
Art. 02.077	H 130 mm.
Art. 02.077.01	H 80 mm.
Art. 02.077.02	H 90 mm.
Art. 02.077.03	H 105 mm.
Art. 02.077.04	H 110 mm.
Art. 02.077.05	H 115 mm.
Art. 02.077.06	H 125 mm.
Art. 02.077.07	H 150 mm.
Art. 02.077.08	H 250 mm.

≠ 20 X 6 mm.

Art. 02.077.09	H 80 mm.
Art. 02.077.10	H 90 mm.
Art. 02.077.11	H 100 mm.
Art. 02.077.12	H 105 mm.
Art. 02.077.13	H 110 mm.
Art. 02.077.14	H 115 mm.
Art. 02.077.15	H 120 mm.
Art. 02.077.16	H 125 mm.
Art. 02.077.17	H 130 mm.
Art. 02.077.18	H 150 mm.
Art. 02.077.19	H 160 mm.
Art. 02.077.20	H 190 mm.
Art. 02.077.21	H 250 mm.

≠ 16 x 6 mm.

Art. 02.074.17	H 100 mm.
Art. 02.074.18	H 110 mm.
Art. 02.074.20	H 120 mm.

□ 12 X 12 mm.

Art. 02.077.22	H 100 mm.
Art. 02.077.23	H 110 mm.
Art. 02.077.24	H 120 mm.
Art. 02.077.25	H 180 mm.

Mart. a caldo / Hot hammered
□ 14 X 14 mm.

Art. 02.077.26	H 100 mm.
Art. 02.077.27	H 110 mm.
Art. 02.077.28	H 115 mm.
Art. 02.077.29	H 120 mm.
Art. 02.077.30	H 125 mm.
Art. 02.077.31	H 130 mm.
Art. 02.077.32	H 135 mm.
Art. 02.077.33	H 140 mm.
Art. 02.077.34	H 160 mm.
Art. 02.077.35	H 180 mm.
Art. 02.077.36	H 250 mm.

Mart. a caldo / Hot hammered
□ 16 X 16 mm.

Art. 02.077.37	H 100 mm.
Art. 02.077.38	H 110 mm.
Art. 02.077.39	H 120 mm.
Art. 02.077.40	H 135 mm.
Art. 02.077.41	H 140 mm.
Art. 02.077.42	H 180 mm.
Art. 02.077.43	H 250 mm.

Pigne a 4 Trafilati / 4 - Element Crowns



H.90 X L.37 mm.
Art. 02.078 □ 8 x 8



H.110 X L.45 mm.
Art. 02.079 □ 10 X 10



H.150 X L.65 mm.
Art. 02.080 □ 12 X 12



Liscio / Smooth
4 Trafilati / Elements
Art. 02.080.ES
H. 125 x L.57 mm □ 12 x 12
Art. 02.081.ES
H. 135 x L.60 mm □ 14 x 14
Art. 02.082.ES
H. 150 x L.70 mm □ 16 x 16



H.160 X L.70 mm.
Art. 02.081 □ 14 X 14



H.160 X L.70 mm.
Art. 02.082 □ 16 X 16



H.210 X L.90 mm.
Art. 02.083 □ 20 X 20



H.210 X L.110 mm.
Art. 02.084 □ 24 X 24
Martellato / Hammered
Art. 02.084.01 □ 24 X 24



H.240 X L.115 mm.
Art. 02.085 □ 30 X 30



4 Quadri da 6 mm
4 Six mm Squares



H.150 X L.50 mm.
Art. 02.089 □ 12 X 12



4 Tondini da 6 mm
4 Six mm Rounds



H.150 X L.50 mm.
Art. 02.090 Ø 12



4 Tondini da 6 mm
4 Six mm Rounds



H.150 X L.60 mm.
Art. 02.091 Ø 12



Art. 02.100 H.195 X L.50 mm. □ 12 X 12
Art. 02.100.01 H.200 X L.60 mm. □ 14 X 14
Art. 02.100.02 H.200 X L.65 mm. □ 16 X 16
Art. 02.100.03 H.195 X L.50 mm. Ø 12
A 9 trafilati / 9 - Element Crowns
Art. 02.100.04 H.195 X L.50 mm. □ 12 X 12



H.100 X L.100 mm.
Art. 02.130
≠ 14 X 6
□ 4 X 4

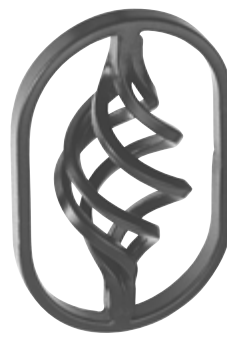

H.160 X L.105 mm.
Art. 02.140
≠ 14 X 6
□ 6 X 6



Pigne a 9 Trafilati / 9 - Element Crowns

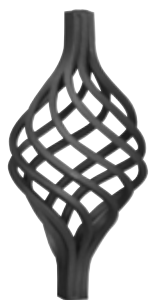

H.155 X L.75 mm.
Art. 02.086 □ 12 X 12

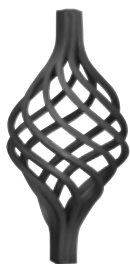

H.125 X L.65 mm.
Art. 02.086.01 □ 12 X 12



H.190 X L.105 mm.
Art. 02.087 □ 24 X 24

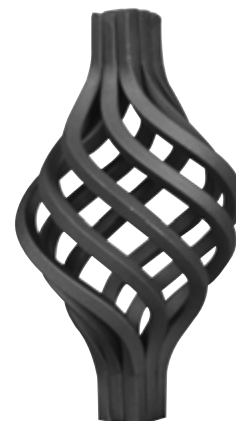

H.245 X L.130 mm.
Art. 02.088 □ 30 X 30



Liscio / Smooth
H. 190 x L.120 mm
Art. 02.200 □ 16 mm
Art. 02.200.01 □ 20 mm



Liscio / Smooth
H. 380 x L.120 mm
Art. 02.201 □ 16 mm



Liscio / Smooth
H. 235 x L.120 mm
Art. 02.202 □ 16 mm



Liscio / Smooth
H. 155 x L.135 mm
Art. 02.203 □ 16 mm
Art. 02.203.01 □ 20 mm



Liscio / Smooth
H. 470 x L.120 mm
Art. 02.204 □ 16 mm



Liscio / Smooth
H. 185 x L.155 mm
Art. 02.205 □ 16 mm



Liscio / Smooth
H. 195 x L.165 mm
Art. 02.206 □ 16 mm



Liscio / Smooth
H. 240 x L.135 mm
Art. 02.207 □ 16 mm

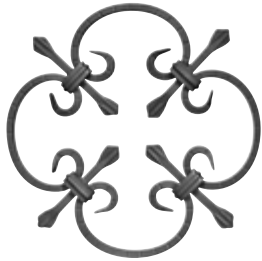

H.250 x L.250 mm
Modello Scala / Scala Model
Art. 03.001 □ 8 x 8
Liscio / Smooth
Art. 03.001.01 □ 8 x 8

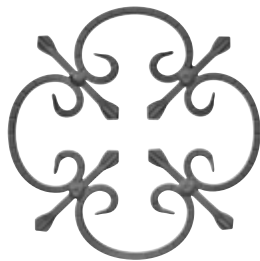

H.250 x L.250 mm
Modello Scala / Scala Model
Art. 03.002 □ 8 x 8
Liscio / Smooth
Art. 03.002.01 □ 8 x 8

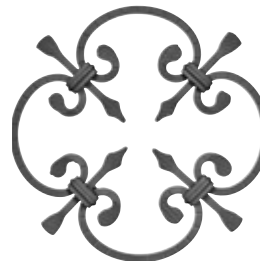

Mod. Scala / Scala Model
H.250 X L.250 mm.
Art. 03.003 □ 8 X 8

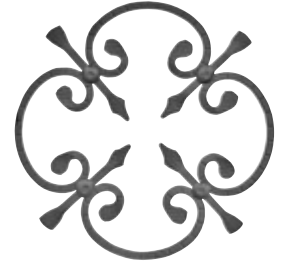

Mod. Scala / Scala Model
H.250 X L.250 mm.
Art. 03.004 □ 8 X 8

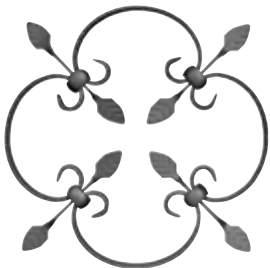

Mod. Scala / Scala Model
H.250 X L.250 mm.
Art. 03.005 ≧ 20 X 4

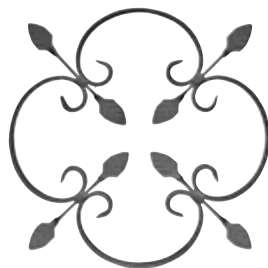

Mod. Scala / Scala Model
H.250 X L.250 mm.
Art. 03.006 ≧ 20 X 4

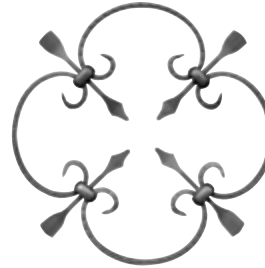

Mod. Scala / Scala Model
H.250 X L.250 mm.
Art. 03.007 ≧ 10 X 5



Mod. Scala / Scala Model
H.250 X L.250 mm.
Art. 03.008 ≧ 10 X 5

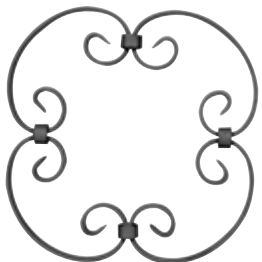

Liscio / Smooth
H.250 X L.250 mm.
Art. 03.009 ≧ 16 X 4

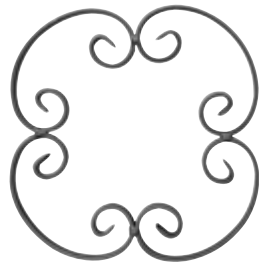

Liscio / Smooth
H.250 X L.250 mm.
Art. 03.010 ≧ 16 X 4

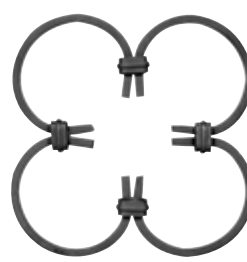

Liscio / Smooth
H.250 X L.250 mm.
Art. 03.011 □ 8 X 8



Liscio / Smooth
H.250 X L.250 mm.
Art. 03.012 □ 8 X 8



H.250 X L.250 mm.
Art. 03.013 □ 8 X 8



Mod. Scala / Scala Model
H.250 X L.250 mm.
Art. 03.014 □ 8 X 8



Liscio / Smooth
H.250 x L.250 mm
Art. 03.014.01 □ 8
Art. 03.014.02 Ø 8



Liscio / Smooth
H.250 x L.250 mm
Art. 03.014.03 ≙ 12 x 4



Liscio / Smooth
H.250 x L.250 mm
Art. 03.014.04 ≙ 12 x 4



Mod. Scala / Scala Model
H.250 X L.250 mm.
Art. 03.015 □ 8 X 8



Mod. Scala / Scala Model
H.250 X L.250 mm.
Art. 03.016 □ 8 X 8



Mod. Scala / Scala Model
H.300 X L.300 mm.
Art. 03.017 □ 8 X 8

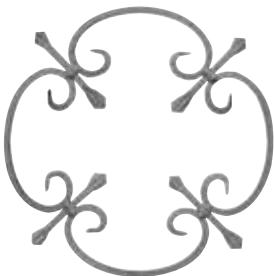

Mod. Scala / Scala Model
H.300 X L.300 mm.
Art. 03.018 □ 8 X 8

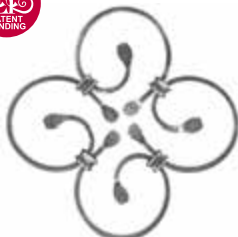

Liscio / Smooth
H.250 X L.250 mm.
Art. 03.018.01 ≙ 12 X 6

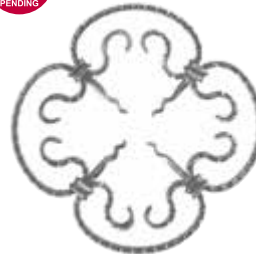

Mod. Scala / Scala Model
H.270 X L.270 mm.
Art. 03.018.03 ≙ 14 X 6



⊗ Tondo / Round
H.380 X L.380 mm.
Art. 03.018.04 Ø 12

Mod. Scala / Scala Model
H.250 X L.250 mm.
Art. 03.018.02 ≙ 12 X 6

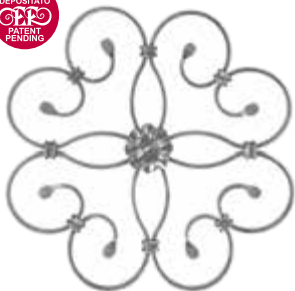

⊗ Liscio / Smooth
H.360 X L.360 mm.
Art. 03.018.05 ≙ 12 X 6
Art. 03.018.16 ≙ 14 X 6

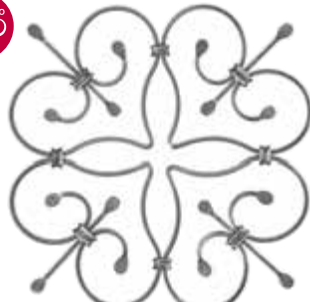

Liscio / Smooth
H.370 X L.370 mm.
Art. 03.018.06 ≙ 12 X 6
Art. 03.018.17 ≙ 14 X 6



Tutte le parti di questo catalogo - foto comprese - sono di proprietà Euro-Fer. La riproduzione, anche parziale, è vietata in ogni forma e con ogni mezzo. / Every part of this catalogue - photos included - is Euro-Fer's property. All forms of copying are strictly prohibited.

🌀 fiori da entrambi i lati / flowers on both sides

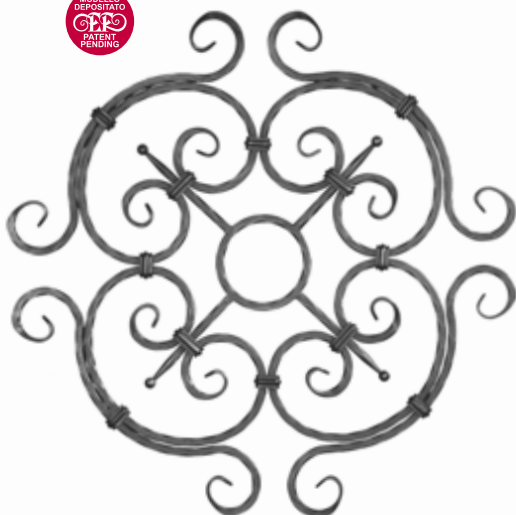

🌀 Mod. Scala / Scala Model

H.445 X L.445 mm.

Art. 03.018.07 ≙ 14 X 6

Art. 03.018.18 ≙ 16 X 6

🌀 Martellato / Hammered

H.710 X L.710 mm.

Art. 03.018.08 □ 12 X 12

🌀 Modello Scala / Scala Model

H.760 x L.760 mm.

Art. 03.018.09 ≙ 14 x 6

Art. 03.018.19 ≙ 16 x 6

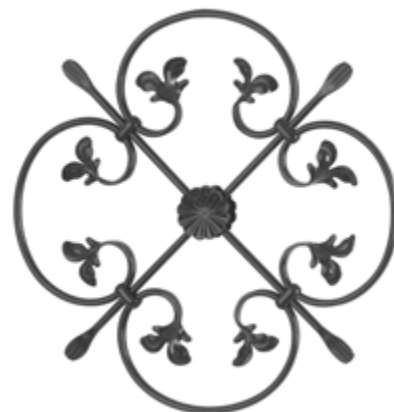

🌀 Martellato / Hammered

H.780 X L.780 mm.

Art. 03.018.10 □ 12 X 12

Art. 03.018.11 □ 14 X 14

🌀 Liscio / Smooth

H.545 X L.545 mm.

Art. 03.018.12 ≙ 12 X 6

🌀 Liscio / Smooth

H.530 X L.530 mm.

Art. 03.018.13 Ø 10

Art. 03.018.20 Ø 12

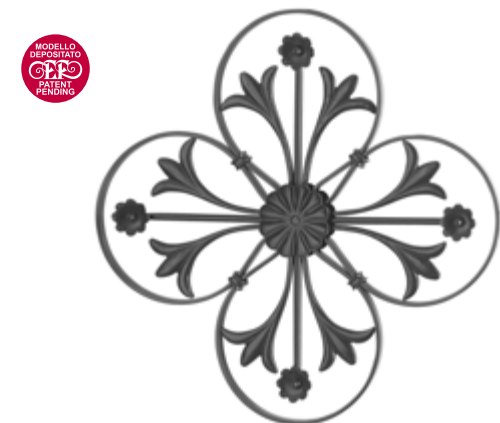

🌀 Liscio / Smooth

H.545 X L.545 mm.

Art. 03.018.14

≙ 12 X 6

Ø 10

Liscio / Smooth

H.250 X L.250 mm.

Art. 03.018.15 Ø 8

🌀

Liscio / Smooth

H.565 x L.565 mm

Art. 03.018.21 Ø 14 mm

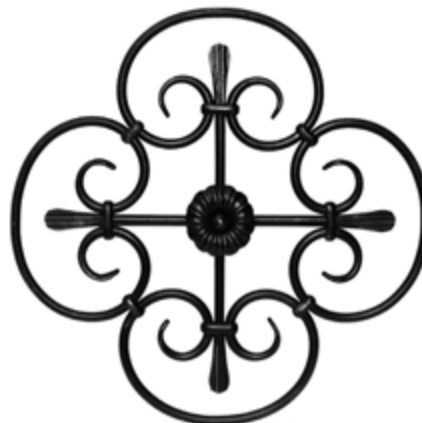

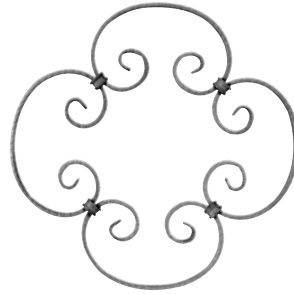
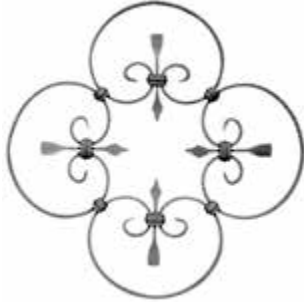
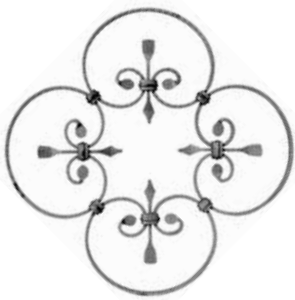
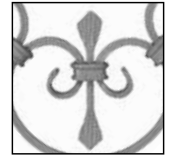
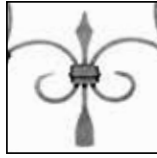
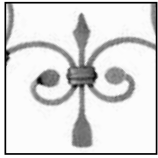

Mod. Scala / Scala Model
H.380 X L.380 mm.
Art. 03.019 ≙ 10 X 5

Mod. Scala / Scala Model
H.380 X L.380 mm.
Art. 03.020 ≙ 10 X 5

Mod. Scala / Scala Model
H.370 X L.370 mm.
Art. 03.021 ≙ 12 X 6

Rigato / Fluted
H.300 X L.300 mm.
Art. 03.022 ≙ 12 X 6

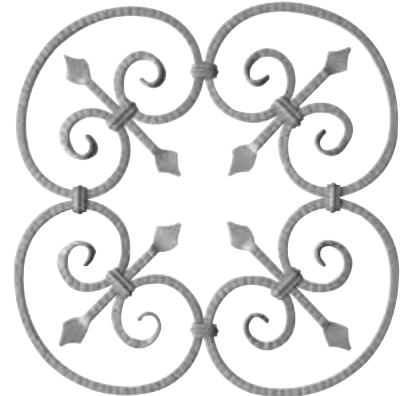
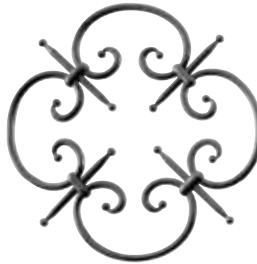
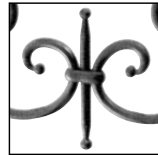

Rigato / Fluted
H.140 X L.205 mm.
Art. 03.023 ≙ 12 X 6

Mod. Scala / Scala Model
H.155 X L.155 mm.
Art. 03.024 □ 6 X 6

Liscio / Smooth
H.330 X L.330 mm.
Art. 03.024.01 Ø 10

Mod. Mattone / Brick Model
H.590 X L.590 mm.
Art. 03.025 □ 12 X 12
Art. 03.025.02 □ 14 X 14

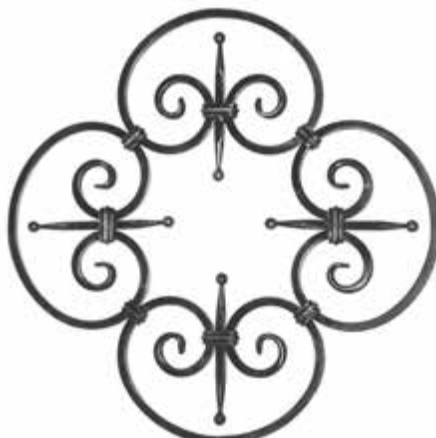

Liscio / Smooth
H.580 X L.580 mm.
Art. 03.025.01 Ø 12
Art. 03.025.03 Ø 14

Liscio / Smooth
H.580 x L.580 mm
Art. 03.025.04 □ 12 mm ;
Art. 03.025.05 □ 14 mm

Liscio / Smooth
H.625 x L. 625
Art. 03.025.10 □ 14x14 mm

Tutte le parti di questo catalogo - foto comprese - sono di proprietà Euro-Fer. La riproduzione, anche parziale, è vietata in ogni forma e con ogni mezzo. / Every part of this catalogue - photos included - is Euro-Fer's property. All forms of copying are strictly prohibited.

 fiori da entrambi i lati / flowers on both sides

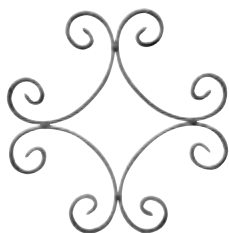

Liscio / Smooth
H.240 X L.240 mm.
Art. 03.026 \approx 16 X 4

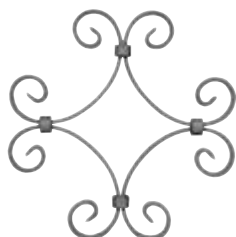

Liscio / Smooth
H.240 X L.240 mm.
Art. 03.027 \approx 16 X 4

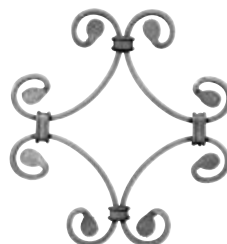

Liscio / Smooth
H.240 X L.240 mm.
Art. 03.028 \approx 12 X 6

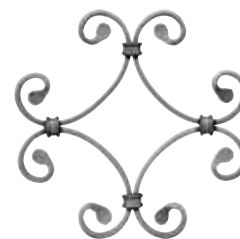

Liscio / Smooth
H.240 X L.240 mm.
Art. 03.029 \approx 12 X 6



Liscio / Smooth
H.360 X L.360 mm.
Art. 03.029.01 \varnothing 10
Art. 03.029.03 \varnothing 12
Art. 03.029.04 \varnothing 14



 Liscio / Smooth
H.360 X L.360 mm.
Art. 03.029.02 \varnothing 10
Art. 03.029.05 \varnothing 12
Art. 03.029.06 \varnothing 14



Liscio / Smooth
H.250 X L.250 mm.
Art. 03.030 \approx 16 X 4



Liscio / Smooth
H.250 X L.250 mm.
Art. 03.031 \approx 16 X 4



Mod. Scala / Scala Model
H.270 X L.270 mm.
Art. 03.031.01 \approx 12 X 6
Art. 03.031.07 \approx 14 X 6



Liscio / Smooth
H.220 X L.220 mm.
Art. 03.031.02 \approx 12 X 6
Art. 03.031.08 \approx 14 X 6

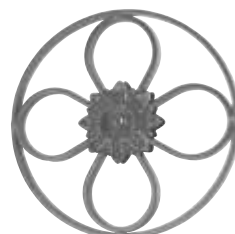

 Liscio / Smooth
H.250 X L.250 mm.
Art. 03.031.03 \approx 12 X 6
Art. 03.031.09 \approx 14 X 6



 Liscio / Smooth
H.250 X L.250 mm.
Art. 03.031.04 \approx 12 X 6



 Liscio / Smooth
H.250 X L.250 mm.
Art. 03.031.05 \varnothing 10



 Liscio / Smooth
H.250 X L.250 mm.
Art. 03.031.06 \varnothing 10



Liscio / Smooth
H.250 X L.250 mm.
Art. 03.032 \approx 16 X 4



Liscio / Smooth
H.250 X L.250 mm.
Art. 03.033 \approx 16 X 4

🌀 fiori da entrambi i lati / flowers on both sides

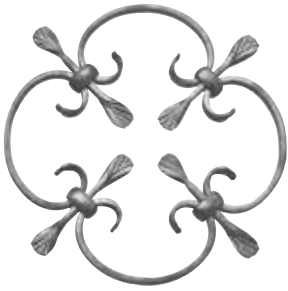

Liscio / Smooth
H.350 X L.350 mm.
Art. 03.033.01 ≡ 12 X 6
H.250 X L.250 mm.
Art. 03.033.02 ≡ 12 X 6

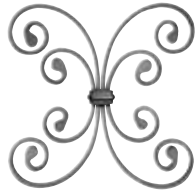

Liscio / Smooth
H.250 X L.250 mm.
Art. 03.034 ≡ 12 X 6



Liscio / Smooth
H.260 X L.260 mm.
Art. 03.034.01 ≡ 12 X 6

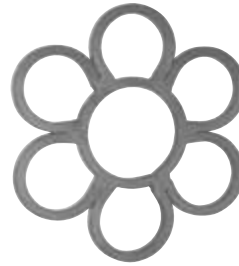

Liscio / Smooth
H.300 X L.300 mm.
Art. 03.034.10 □ 12 X 12

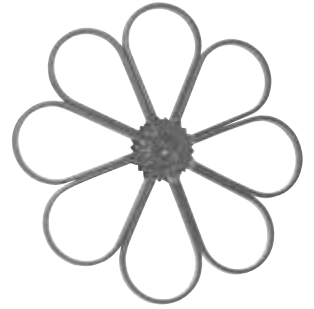

🌀 Liscio / Smooth
H.380 X L.380 mm.
Art. 03.034.12 ≡ 12 X 6



Liscio / Smooth
H.530 X L.530 mm.
Art. 03.034.21 ≡ 12 X 6



🌀 Liscio / Smooth
H.470 X L.470 mm.
Art. 03.034.22 Ø 10
Art. 03.034.29 Ø 12
Art. 03.034.30 Ø 14
Art. 03.034.31 Ø 16

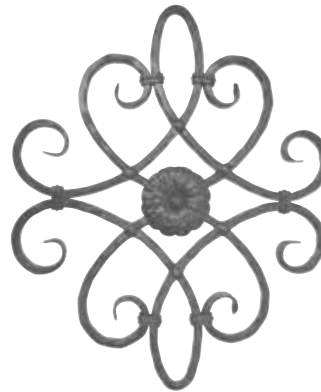

🌀 Martellato / Hammered
H.520 X L.420 mm.
Art. 03.034.23 □ 12 X 12
Art. 03.034.32 □ 14 X 14
Liscio / Smooth
H.520 x L.420 mm
Art. 03.034.41 □ 12 X 12
Art. 03.034.42 Ø 12
Art. 03.034.43 Ø 14

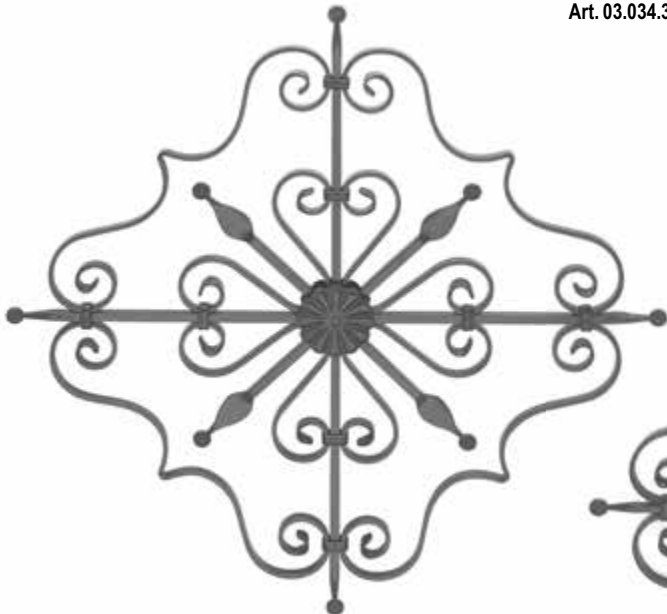

🌀 Liscio / Smooth
H.830 X L.830 mm.
Art. 03.034.24
≡ 12 X 6
□ 12 X 12
Art. 03.034.33
≡ 14 X 6
□ 14 X 14

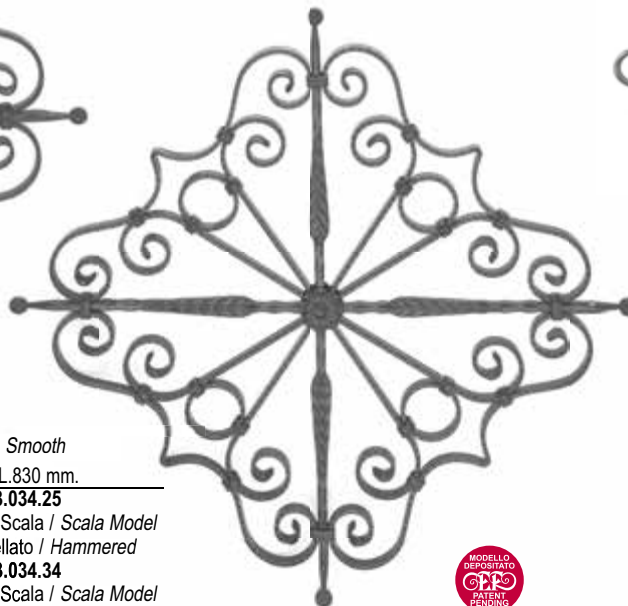

🌀 Liscio / Smooth
H.830 X L.830 mm.
Art. 03.034.25
≡ 12 X 6 Mod. Scala / Scala Model
□ 12 X 12 Martellato / Hammered
Art. 03.034.34
≡ 14 X 6 Mod. Scala / Scala Model
□ 14 X 14 Martellato / Hammered

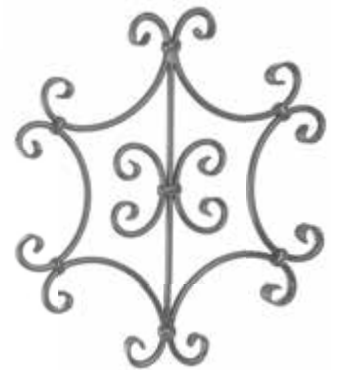

Liscio / Smooth
H.500 X L.500 mm.
Art. 03.034.26 Ø 12
Art. 03.034.27 Ø 14
Art. 03.034.28 Ø 16



Tutte le parti di questo catalogo - foto comprese - sono di proprietà Euro-Fer. La riproduzione, anche parziale, è vietata in ogni forma e con ogni mezzo. / Every part of this catalogue - photos included - is Euro-Fer's property. All forms of copying are strictly prohibited.

🌀 fiori da entrambi i lati / flowers on both sides

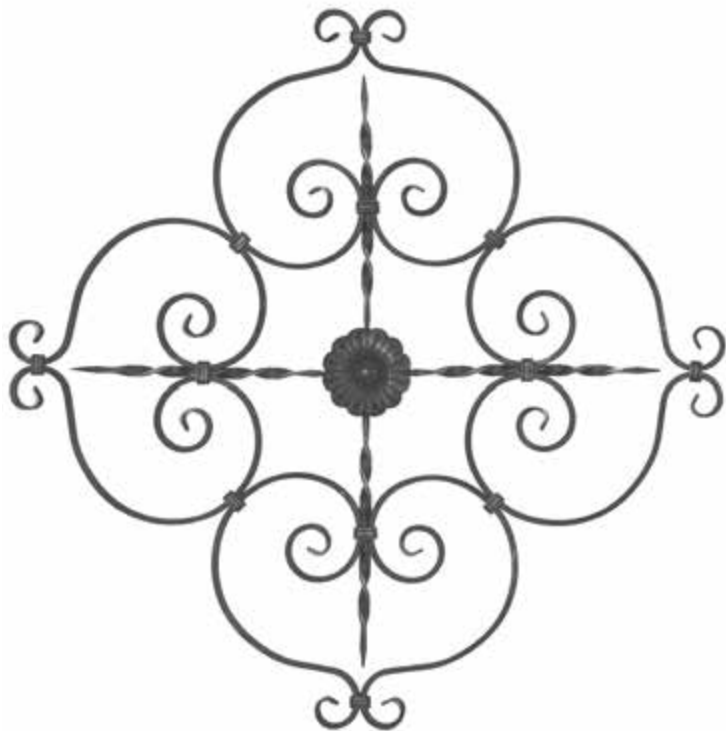

🌀 Liscio / Smooth
H.970 x L.970 mm
Art. 03.034.35 \neq 16 x 8

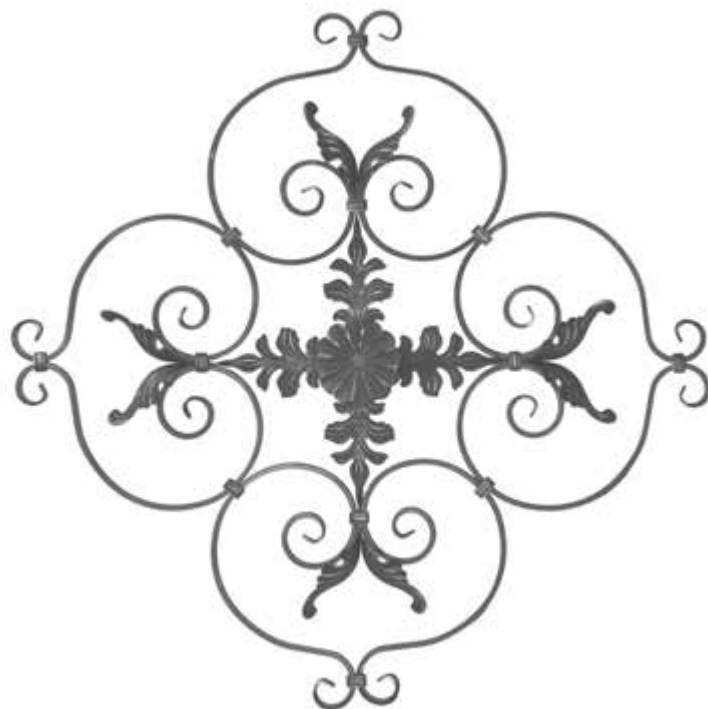

🌀 Liscio / Smooth
H.970 x L.970 mm
Art. 03.034.36 \neq 16 x 8



Liscio / Smooth
L.200 x H.200 mm
Art. 03.034.38 \neq 12 x 6



🌀 Liscio / Smooth
L.315 x H.315 mm
Art. 03.034.39 \varnothing 8



🌀 Martellato / Hammered
H.950 x L.430 mm
Art. 03.034.40 \square 12
Fiori su ambo i lati
Flowers on both sides



Art. 03.034.50
Art. 03.034.51

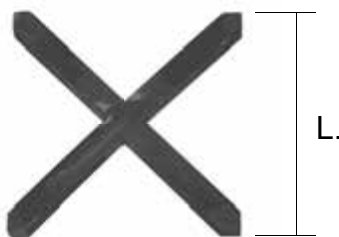

Liscio / Smooth
Art. 03.034.60 \square 12 L.100 x H.100 mm
Art. 03.034.61 \square 12 L.110 x H.110 mm
Art. 03.034.62 \square 12 L.125 x H.125 mm
Art. 03.034.63 \square 12 L.108 x H.108 mm



Modello Scala / *Scala Model*
H.155 X L.180 mm.
Art. 03.035 ≙ 10 X 5



Modello Scala / *Scala Model*
H.180 X L.130 mm.
Art. 03.035.01 ≙ 10 X 5

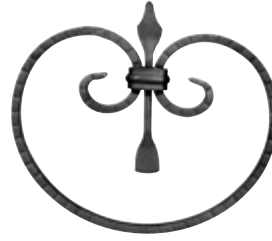

Modello Scala / *Scala Model*
H.155 X L.180 mm.
Art. 03.036 ≙ 10 X 5

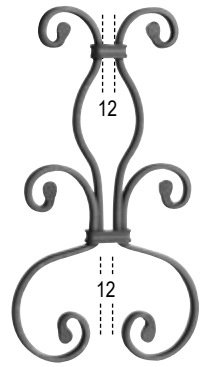

H.350 X L.190 mm.
Art. 03.036.01 ≙ 12 X 6



H.110 X L.125 mm.
Art. 03.036.02 ∅ 8



H.125 X L.115 mm.
Art. 03.037 ≙ 12 X 6
Art. 03.038 □ 8 X 8

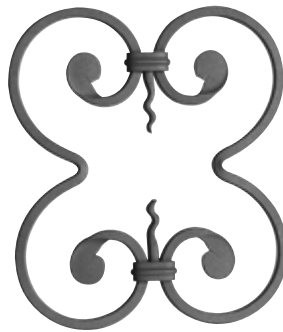

H.240 X L.210 mm.
Art. 03.038.01 □ 8 X 8



H.215 X L.155 mm.
Art. 03.039 ≙ 12 X 6



H.215 X L.155 mm.
Art. 03.040 ≙ 12 X 6



H.215 X L.165 mm.
Art. 03.041 ≙ 12 X 6

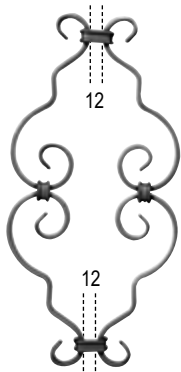

H.380 X L.185 mm.
Art. 03.042 ≙ 12 X 6

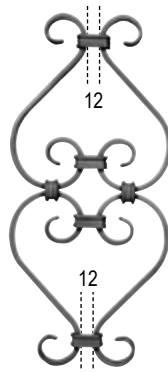

H.360 X L.165 mm.
Art. 03.043 ≙ 12 X 6

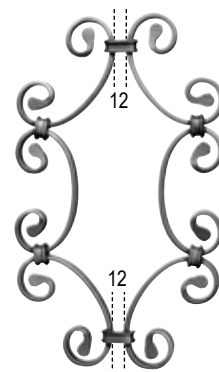

H.380 X L.230 mm.
Art. 03.044 ≙ 12 X 6

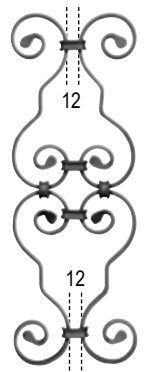

H.480 X L.170 mm.
Art. 03.045 ≙ 12 X 6

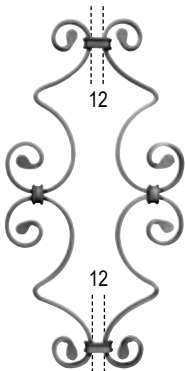

H.440 X L.225 mm.
Art. 03.046 ≙ 12 X 6

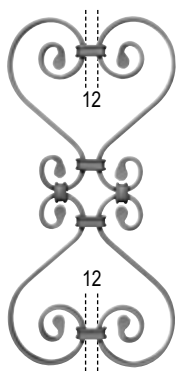

H.410 X L.200 mm.
Art. 03.047 ≙ 12 X 6

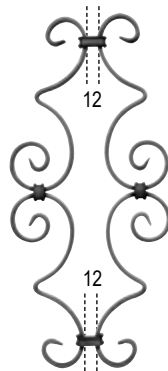

H.450 X L.205 mm.
Art. 03.048 ≙ 12 X 6

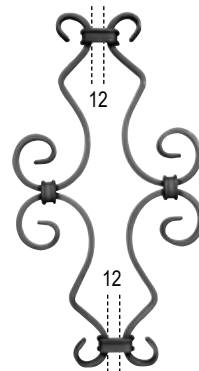

H.330 X L.180 mm.
Art. 03.049 ≙ 12 X 6

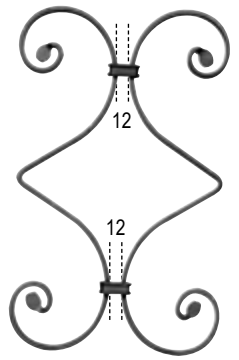

H.385 X L.230 mm.
Art. 03.050 ≙ 12 X 6

Tutte le parti di questo catalogo - foto comprese - sono di proprietà Euro-Fer. La riproduzione, anche parziale, è vietata in ogni forma e con ogni mezzo. / Every part of this catalogue - photos included - is Euro-Fer's property. All forms of copying are strictly prohibited.

🌀 fiori da entrambi i lati / flowers on both sides

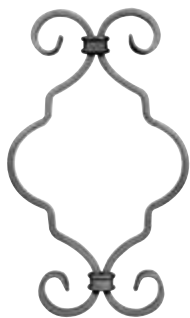

H.250 X L.160 mm.
Art. 03.051 ≙ 12 X 6



H.185 X L.200 mm.
Art. 03.051.01 ≙ 12 X 6
Art. 03.051.06 ≙ 14 X 6

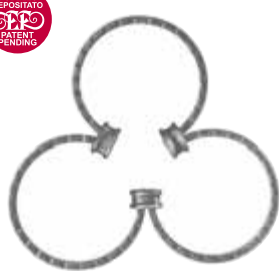

H.185 X L.200 mm.
Art. 03.051.02 ≙ 12 X 6
Art. 03.051.07 ≙ 14 X 6
Modello Scala / Scala Model



H.380 X L.135 mm.
Art. 03.051.03 ≙ 12 X 6



H.300 X L.115 mm.
Art. 03.051.04 ≙ 12 X 6
Art. 03.051.05 ≙ 14 X 6
Modello Scala / Scala Model



Liscio / Smooth
H.440 x L.160 mm
Art. 03.051.08 ≙ 14 x 6 mm
Art. 03.051.09 ≙ 16 x 6 mm



Liscio / Smooth
H.420 x L.180 mm
Art. 03.051.10 ≠ 12 x 6
Art. 03.051.11 ≠ 14 x 6

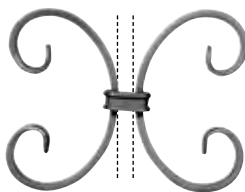

H.135 X L.165 mm.
Art. 03.052 ≙ 12 X 6

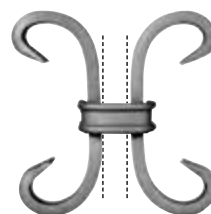

H.95 X L.95 mm.
Art. 03.053 ≙ 12 X 6

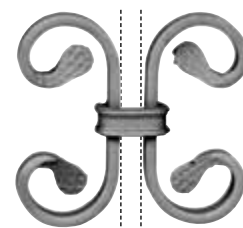

H.100 X L.110 mm.
Art. 03.054 ≙ 12 X 6



Liscio / Smooth
H.200 X L.190 mm.
Art. 03.055 ∅ 10



🌀 Liscio / Smooth
H.100 X L.210 mm.
Art. 03.056 ≙ 12 X 6



Liscio / Smooth
H.100 X L.265 mm.
Art. 03.057 ∅ 10



Liscio / Smooth
H.85 X L.230 mm.
Art. 03.058 ≙ 12 X 6



Liscio / Smooth
H.250 X L.170 mm.
Art. 03.059 □ 14 X 14



Liscio / Smooth
H.190 mm.
Art. 03.060 ≙ 12 X 6



Liscio / Smooth
H.290 X L.100 mm.
Art. 03.061 ≙ 12 X 6



Liscio / Smooth
H.125 mm.
Art. 03.062 □ 8 X 8



Liscio / Smooth
H.340 mm.
Art. 03.063 ∅ 12
Sinistro - Left



Liscio / Smooth
H.340 mm.
Art. 03.064 ∅ 12
Destro - Right

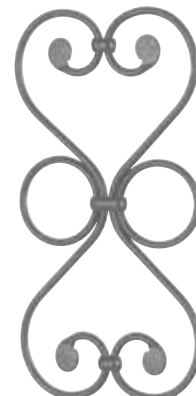

Liscio / Smooth
H.390 X L.200 mm.
Art. 03.065 ∅ 8



Liscio / Smooth
H.370 X L.240 mm.
Art. 03.066 Ø 10

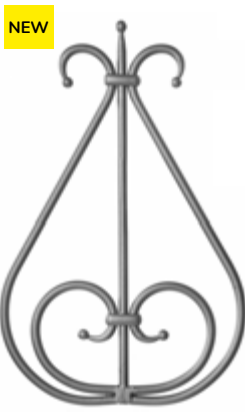

Liscio / Smooth
H.465 x L.300 mm
Art. 03.066.01 Ø 12

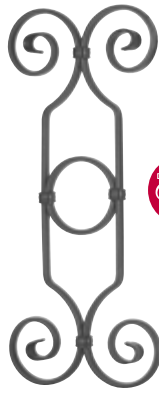

Liscio / Smooth
H.470 X L.210 mm.
Art. 03.067 ≙ 12 X 6
Art. 03.067.01 ≙ 14 X 6

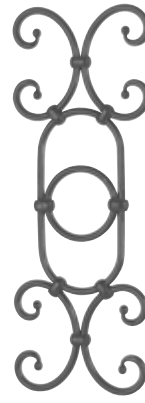

Liscio / Smooth
H.495 X L.180 mm.
Art. 03.068 Ø 10

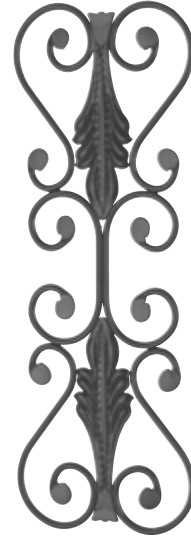

Liscio / Smooth
H.620 X L.235 mm.
Art. 03.069 Ø 8

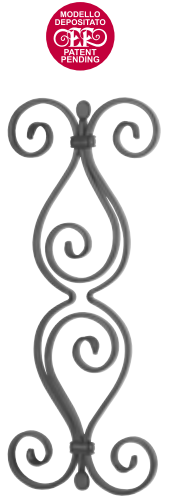

Liscio / Smooth
H.460 X L.185 mm.
Art. 03.070 ≙ 12 X 6
Art. 03.070.01 ≙ 14 X 6

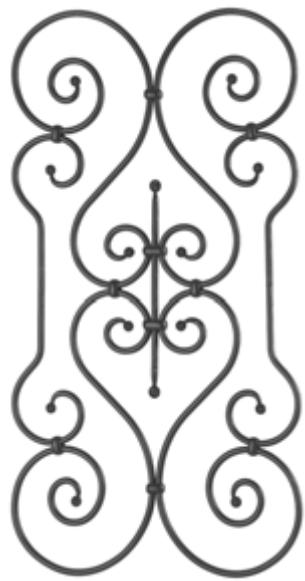

Liscio / Smooth
H.840 X L.440 mm.
Art. 03.071 Ø 10
Art. 03.071.01 Ø 12



Liscio / Smooth
H.400 X L.125 mm
Art. 03.080 □ 12 X 12

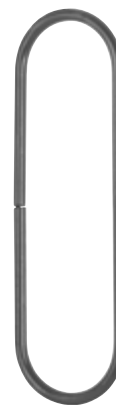

Liscio / Smooth
H.400 X L.125 mm.
Art. 03.081 Ø 12

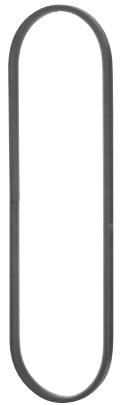

Liscio / Smooth
H.400 X L.115 mm.
Art. 03.082 ≙ 12 X 6

OVALI NON SALDATI / NOT WELDED OVALS

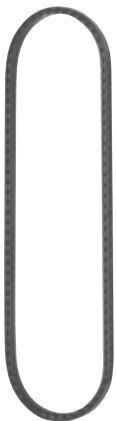

Mod. Scala / Scala Model
H.400 X L.115 mm.
Art. 03.083 ≙ 12 X 6



Liscio / Smooth
H.400 X L.125 mm
Art. 03.084 □ 12 X 12



Liscio / Smooth
H.400 X L.125 mm.
Art. 03.085 Ø 12



Liscio / Smooth
H.400 X L.115 mm.
Art. 03.086 ≙ 12 X 6



Mod. Scala / Scala Model
H.400 X L.115 mm.
Art. 03.087 ≙ 12 X 6



Liscio / Smooth
Art. 03.088 □ 14 H.710 x L.126 mm
Art. 03.088.01 □ 14 H.590 x L.126 mm
Art. 03.088.02 □ 14 H.540 x L.126 mm
Art. 03.088.03 □ 14 H.410 x L.126 mm

Tutte le parti di questo catalogo - foto comprese - sono di proprietà Euro-Fer. La riproduzione, anche parziale, è vietata in ogni forma e con ogni mezzo. / Every part of this catalogue - photos included - is Euro-Fer's property. All forms of copying are strictly prohibited.

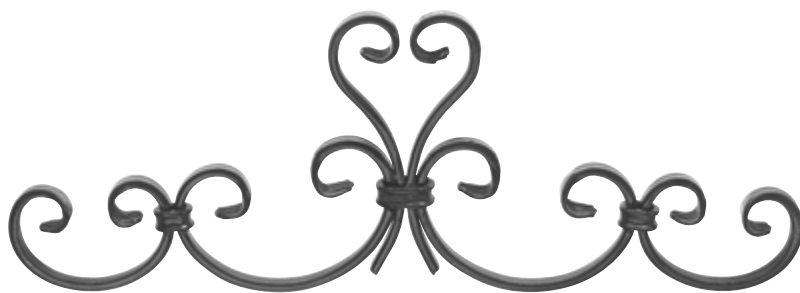

Liscio / Smooth
H.175 X L.500 mm.
Art. 03.090 \neq 12 X 6

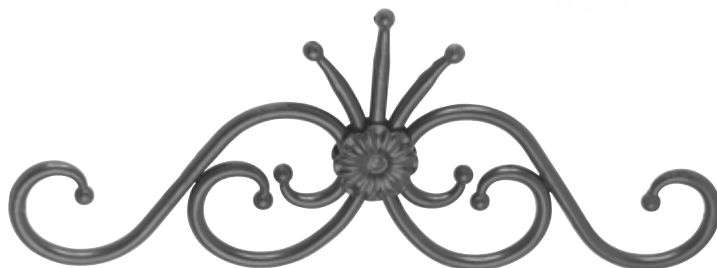

Liscio / Smooth
H.210 X L.530 mm.
Art. 03.091 \neq 12
Art. 03.091.01 \neq 14



Liscio / Smooth
H.260 X L.885 mm.
Art. 03.092 \neq 12



Liscio / Smooth
H.300 X L.835 mm.
Art. 03.093 \neq 20 X 5



Liscio / Smooth
H.235 X L.580 mm.
Art. 03.094 \neq 10

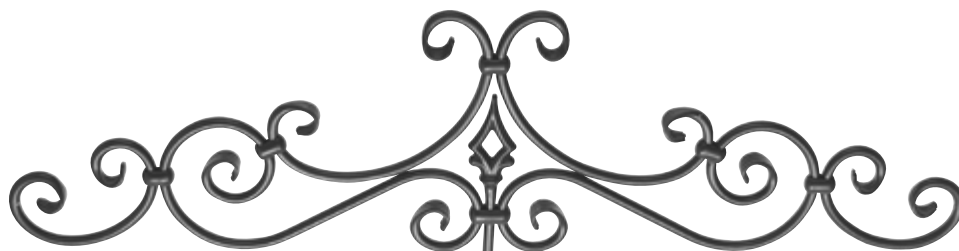

Liscio / Smooth
H.235 X L.860 mm.
Art. 03.095 \neq 10



Liscio / Smooth
H.330 X L.1000 mm.
Art. 03.096 □ 12
Art. 03.096.01 □ 14
Art. 03.096.02 □ 16



Liscio / Smooth
L.1000 x H.110 mm
Art. 03.096.50 Ø 10
Con fiori su ambo i lati /
Flowers on both sides



Liscio / Smooth
L.1000 x H.110 mm
Art. 03.096.51 □ 10
Con fiori su ambo i lati /
Flowers on both sides



Attorcigliato / Twisted
L.1000 x H.110 mm
Art. 03.096.52 □ 10
Con fiori su ambo i lati /
Flowers on both sides



Modello Scala / Scala Model
L.1000 x H.110 mm
Art. 03.096.53 ≧ 12 x 6
Con fiori su ambo i lati /
Flowers on both sides



Liscio / Smooth
L.1230 x H.350 mm
Art. 03.097 ≧ 30 x 10

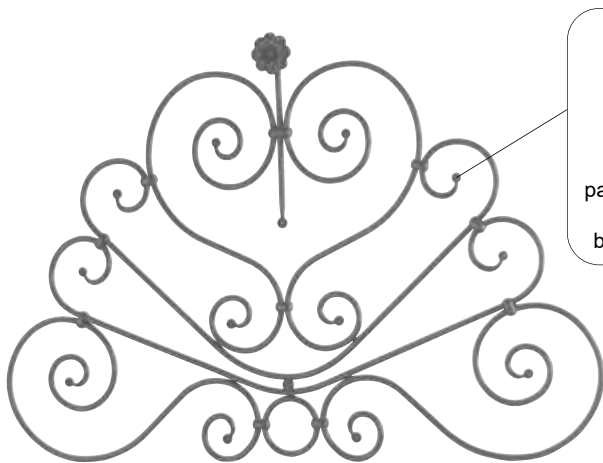

Liscio / Smooth
H.630 X L.930 mm.
Art. 03.100 Ø 10
Art. 03.100.01 Ø 12

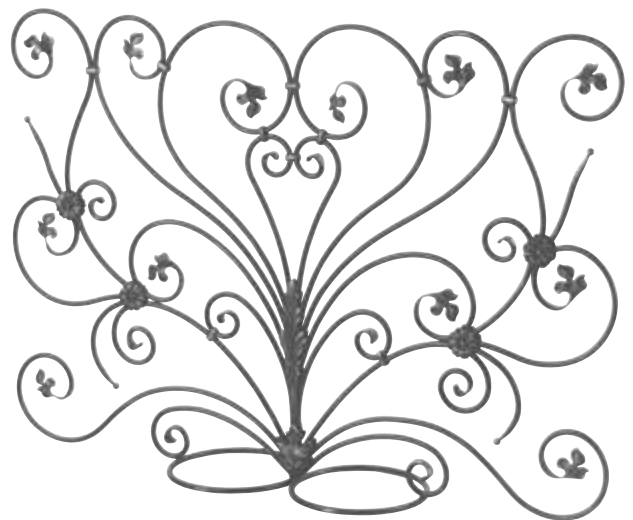

Liscio / Smooth
H.900 X L.1300 mm.
Art. 03.101 Ø 12



Liscio / Smooth
H.900 X L.650 mm.
Art. 03.102 \varnothing 12
Sinistro - Left



Liscio / Smooth
H.900 X L.650 mm.
Art. 03.103 \varnothing 12
Destro - Right



Liscio / Smooth
H.600 x L.600 mm
Art. 03.104 \varnothing 16 x 8
Sinistro / Left



Liscio / Smooth
H.600 x L.600 mm
Art. 03.105 \varnothing 16 x 8
Destro / Right



Martellato / Hammered
H.600 x L.600 mm
Art. 03.106 \varnothing 16 x 8
Sinistro / Left



Martellato / Hammered
H.600 x L.600 mm
Art. 03.107 \varnothing 16 x 8
Destro / Right



Art. 03.400
Liscio / Smooth
H.296 x L.296 mm ca.
□ 12 mm



Art. 03.600
Martellato / Hammered
H.400 x L.400 mm ca.
Ø 12 mm

Art. 03.602
Liscio / Smooth
H.400 x L.400 mm ca.
Ø 10 mm

Art. 03.601
Modello Corteccia / Bark Model
H.400 x L.400 mm ca.
Ø 12 mm

Art. 03.610
Liscio / Smooth
H. 400 x L.400 mm c.a.
□ 10 mm



Martellato / Hammered
H.85 x L.295 mm
Art. 03.645 ≙ 12 x 6
Art. 03.645.01 ≙ 16 x 8 NEW

Liscio / Smooth
H.85 x L.295 mm
Art. 03.646 ≙ 12 x 6 NEW
Art. 03.646.01 ≙ 16 x 8



Martellato / Hammered
H.270 x L.245 mm
Art. 03.650 ≙ 12 x 6



Martellato / Hammered
H.235 x L.390 mm
Art. 03.651. ≙ 12 x 6



🌀 fiori da entrambi i lati / flowers on both sides

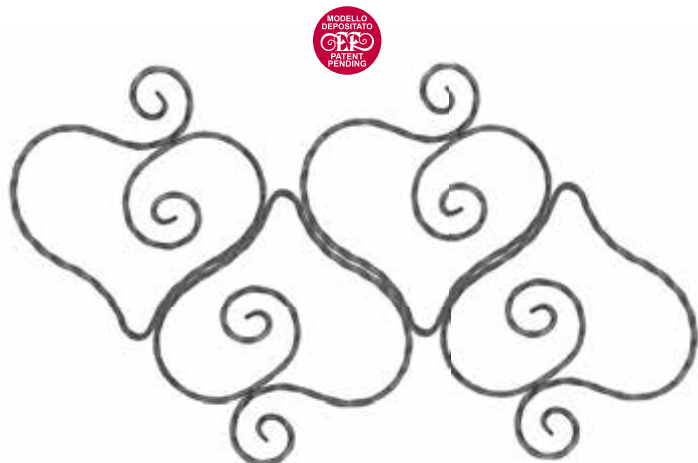

Martellato / *Hammered*
H.410 x L.620 mm
Art. 03.652. ≙ 12 x 6

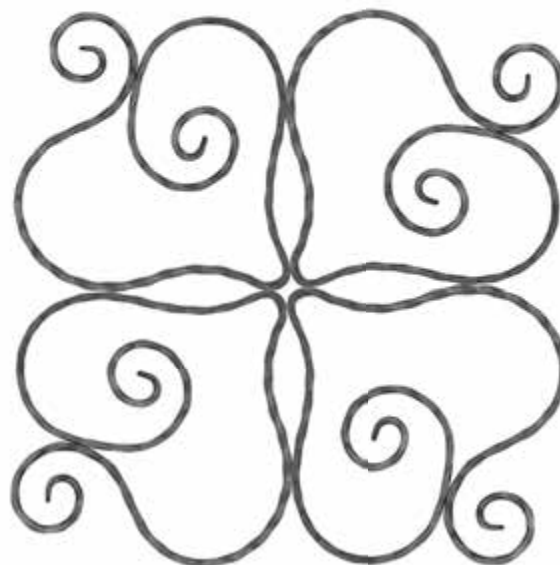

Martellato / *Hammered*
H.430 x L.430 mm
Art. 03.655. ≙ 12 x 6

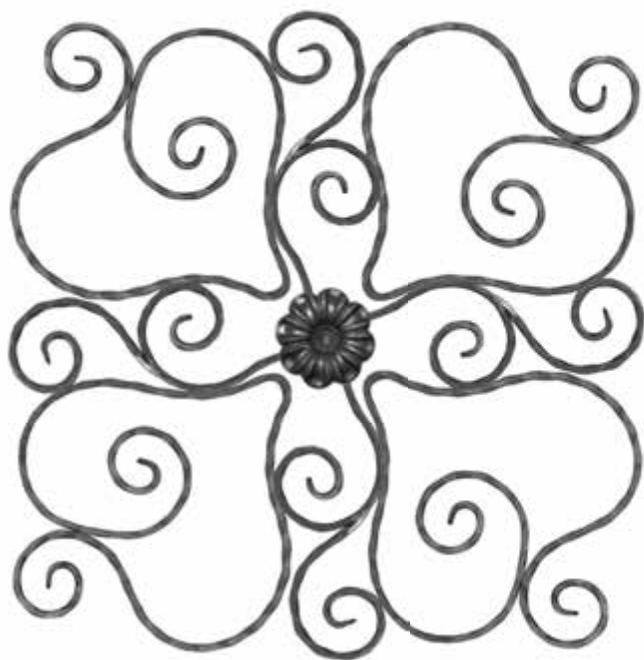

🌀 Martellato / *Hammered*
H.510 x L.510 mm
Art. 03.657 ≙ 12 x 6



🌀 fiori da entrambi i lati / flowers on both sides



🌀 Liscio / Smooth
H.460 x L.460 mm
Art. 03.700 □ 12 mm



Liscio / Smooth
H.420 x L.420 mm
Art. 03.701 Ø 12 mm

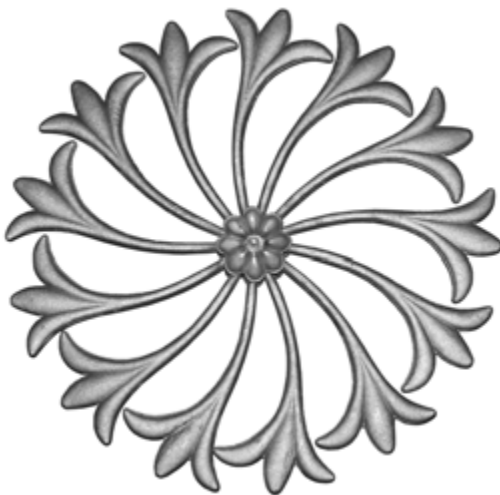

🌀 Liscio / Smooth
H.400 x L.400 mm
Art. 03.702
spessore / thickness 10 mm



Liscio / Smooth
H.460 x L.460 mm
Art. 03.703 Ø 12 mm



Liscio / Smooth
H.415 x L.415 mm
Art. 03.704 □ 12 mm



🌀 Liscio / Smooth
H.460 x L.460 mm
Art. 03.705 □ 12 mm

🌀 fiori da entrambi i lati / flowers on both sides



Liscio / Smooth
H.215 x L.215 mm
Art. 03.706 ≙ 16 x 4



Liscio / Smooth
H.200 x L.200 mm
Art. 03.707 Ø 10



🌀 Liscio / Smooth
H.260 x L.260 mm
Art. 03.708 ≙ 12 x 6



Liscio / Smooth
H.250 x L.250 mm
Art. 03.709 Ø 12



Liscio / Smooth
H.250 x L.250 mm
Art. 03.710 ≙ 14 x 6

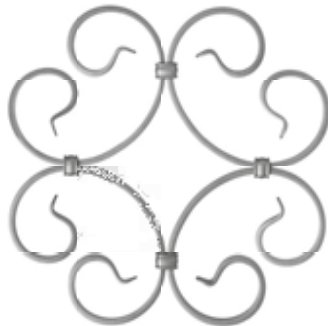

Liscio / Smooth
H.290 x L.290 mm
Art. 03.711 ≙ 12 x 6



🌀 Liscio / Smooth
H.300 x L.300 mm
Art. 03.712 ≙ 12 x 6

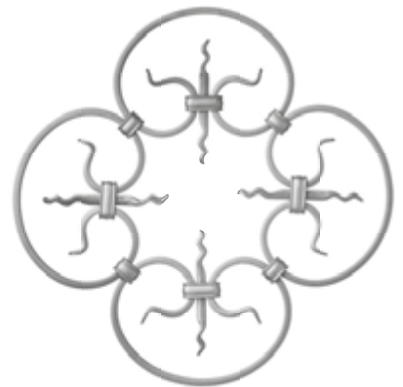

Liscio / Smooth
H.330 x L.330 mm
Art. 03.713 ≙ 12 x 6



🌀 Liscio / Smooth
H.250 x L.250 mm
Art. 03.714 ≙ 16 x 8

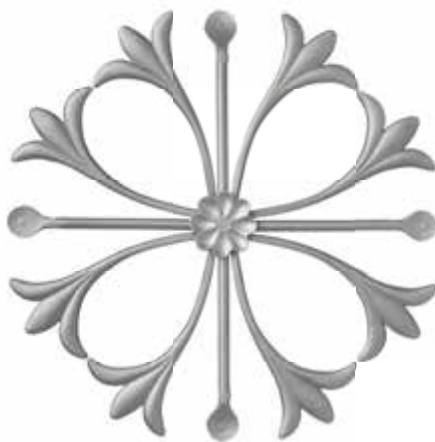

🌀 Liscio / Smooth
H.380 x L.380 mm
Art. 03.715 Ø 10

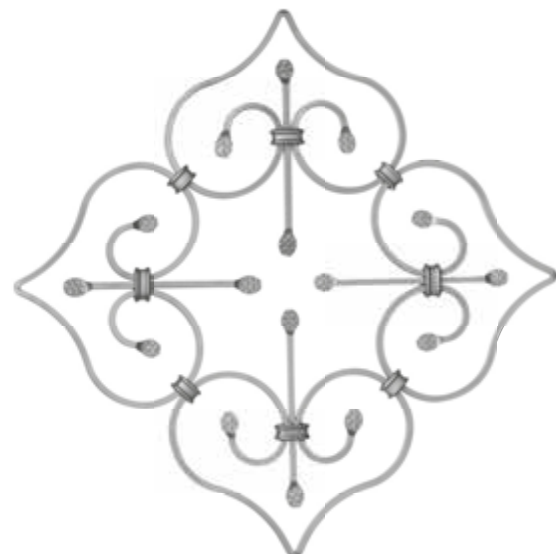

Liscio / Smooth
H.480 x L.480 mm
Art. 03.716 ≙ 12 x 6

🌀 fiori da entrambi i lati / flowers on both sides

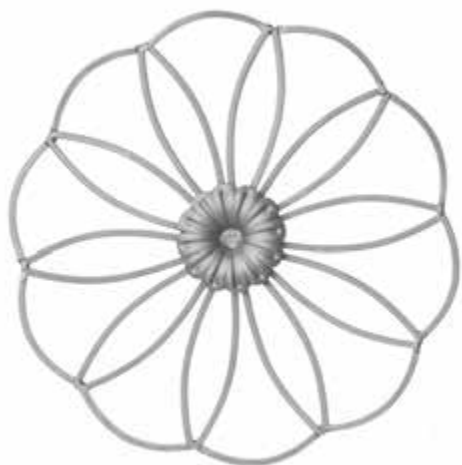

🌀 Liscio / Smooth
H.400 x L.400 mm
Art. 03.717 ≙ 12 x 6
fiore / flower 95 mm

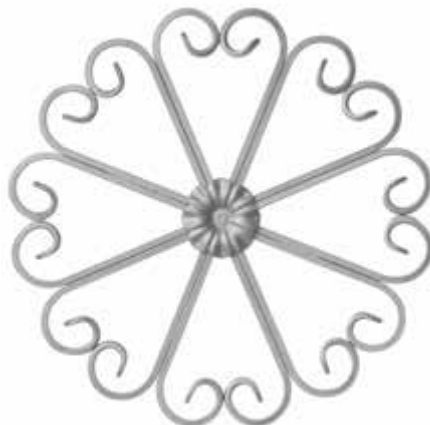

🌀 Liscio / Smooth
H.330 x L.330 mm
Art. 03.718 ≙ 12 x 6
fiore / flower 60 mm



Mod. Scala / Scala model
Ø 270 mm
Art. 03.719 ≙ 12 x 6



🌀 Liscio / Smooth
Ø 215 mm
Art. 03.720 ≙ 14 x 6



🌀 Liscio / Smooth
Ø 190 mm
Art. 03.721 ≙ 12 x 6

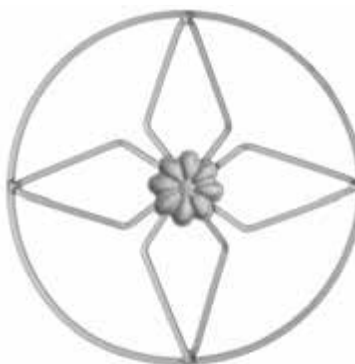

🌀 Liscio / Smooth
Ø 280 mm
Art. 03.722 ≙ 12 x 6



🌀 Liscio / Smooth
Ø 220 mm
Art. 03.723 ≙ 14 x 6

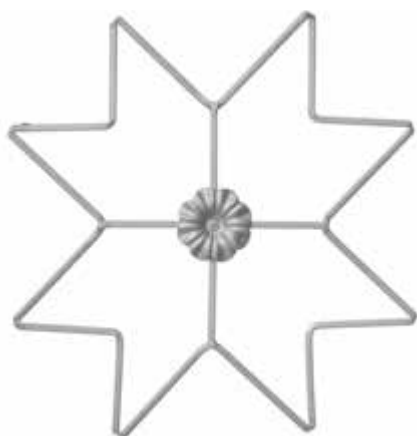

🌀 Liscio / Smooth
H.360 x L.360 mm
Art. 03.724 ≙ 12 x 6
fiore / flower 60 mm



🌀 Liscio / Smooth
Ø 400 mm
Art. 03.725 ≙ 12 x 6
fiore / flower 60 mm

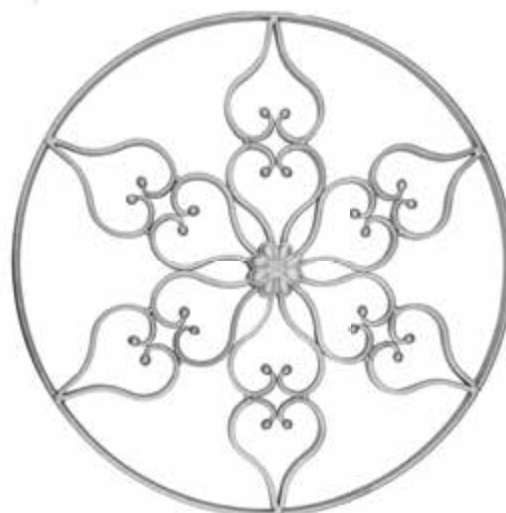

🌀 Liscio / Smooth
Ø 500 mm
Art. 03.726 ≙ 12 x 6
fiore / flower 60 mm



Tutte le parti di questo catalogo - foto comprese - sono di proprietà Euro-Fer. La riproduzione, anche parziale, è vietata in ogni forma e con ogni mezzo. / Every part of this catalogue - photos included - is Euro-Fer's property. All forms of copying are strictly prohibited.

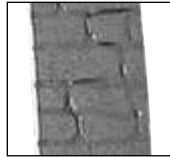

Modello Mattone
Brick Model



H.950 X L.300 mm. \neq 40 X 4
Art. 04.001 Liscio / Smooth
Art. 04.002 Mattone / Brick



H.720 X L.250 mm. \neq 40 X 4
Art. 04.003 Liscio / Smooth
Art. 04.004 Mattone / Brick



H.720 X L.250 mm. \neq 40 X 4
Art. 04.005 Liscio / Smooth
Art. 04.006 Mattone / Brick



H.950 X L.220 mm. \neq 40 X 4
Art. 04.007 Liscio / Smooth
Art. 04.008 Mattone / Brick



H.950 X L.180 mm. \neq 40 X 4
Art. 04.009 Liscio / Smooth
Art. 04.010 Mattone / Brick



H.370 X L.125 mm. \neq 40 X 4
Art. 04.011 Liscio / Smooth
Art. 04.012 Mattone / Brick



Liscio / Smooth
H.440 X L.75 mm.
Art. 04.012.01 \neq 40 X 4



Liscio / Smooth
H.440 X L.75 mm.
Art. 04.012.02 \neq 40 X 4



Mattone / Brick
H.440 X L.75 mm.
Art. 04.012.03 \neq 40 X 4



Mattone / Brick
H.440 X L.75 mm.
Art. 04.012.04 \neq 40 X 4

Tutte le parti di questo catalogo - foto comprese - sono di proprietà Euro-Fer. La riproduzione, anche parziale, è vietata in ogni forma e con ogni mezzo. / Every part of this catalogue - photos included - is Euro-Fer's property. All forms of copying are strictly prohibited.



H.800 X L.135 mm. Liscio / Smooth
 Art. 04.013 ≙ 20 X 4
 Art. 04.014 ≙ 25 X 4
 Art. 04.015 ≙ 30 X 4
 Art. 04.016 ≙ 40 X 4



H.800 X L.135 mm. Mattone / Brick
 Art. 04.017 ≙ 20 X 4
 Art. 04.018 ≙ 25 X 4
 Art. 04.019 ≙ 30 X 4
 Art. 04.020 ≙ 40 X 4



H.900 X L.240 mm. ≙ 40 X 6
 Art. 04.021 Liscio / Smooth



Liscio / Smooth
 H.950 X L.240 mm.
 Art. 04.021.01 ≙ 40 X 4



Liscio / Smooth
 H.950 X L.240 mm.
 Art. 04.021.02 ≙ 40 X 4



Liscio / Smooth
 H.950 X L.240 mm.
 Art. 04.021.03 ≙ 40 X 4



Mattone / Brick
 H.950 X L.240 mm.
 Art. 04.021.04 ≙ 40 X 4



Mattone / Brick
 H.950 X L.240 mm.
 Art. 04.021.05 ≙ 40 X 4



Mattone / Brick
 H.950 X L.240 mm.
 Art. 04.021.06 ≙ 40 X 4



H.950 x L.190 mm
 Martellato / Hammered
 Art. 04.021.10 ≙ 30 x 8 mm
 Liscio / Smooth
 Art. 04.021.11 ≙ 30 x 8 mm



H.750 X L.110 mm.
 Art. 04.022 ≡ 20 X 4
 Art. 04.023 ≡ 20 X 5



H.900 X L.180 mm.
 Art. 04.024 ≡ 16 X 4
 Art. 04.025 ≡ 20 X 6
 Art. 04.026 □ 8 X 8



H.850 X L.170 mm.
 Art. 04.027 ≡ 25 X 5

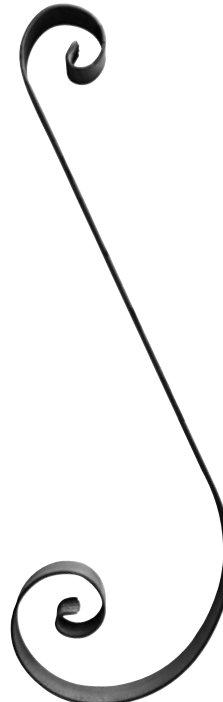

H.780 X L.250 mm.
 Art. 04.028 ≡ 30 X 4
 Art. 04.029 ≡ 25 X 5



Liscio / Smooth
 H.730 x L.250 mm
 Art. 04.029.01 ≡ 30 x 10



H.720 X L.130 mm.
 Art. 04.030 ≡ 16 X 4
 Art. 04.031 ≡ 10 X 5
 Art. 04.032 ≡ 20 X 6
 Art. 04.033 □ 8 X 8



H.720 X L.75 mm.
 Art. 04.034 ≡ 16 X 4
 Art. 04.035 ≡ 10 X 5
 Art. 04.036 ≡ 20 X 6
 Art. 04.037 □ 8 X 8



H.720 X L.75 mm.
 Art. 04.038 ≡ 16 X 4
 Art. 04.039 ≡ 10 X 5
 Art. 04.040 ≡ 20 X 6
 Art. 04.041 □ 8 X 8



H.800 X L.115 mm.
 Art. 04.042 ≡ 16 X 4
 Art. 04.043 ≡ 20 X 4
 Art. 04.044 ≡ 25 X 4



H.720 X L.75 mm.
 Art. 04.045 ≡ 16 X 4
 Art. 04.046 ≡ 10 X 5
 Art. 04.047 ≡ 20 X 6

Tutte le parti di questo catalogo - foto comprese - sono di proprietà Euro-Fer. La riproduzione, anche parziale, è vietata in ogni forma e con ogni mezzo. / Every part of this catalogue - photos included - is Euro-Fer's property. All forms of copying are strictly prohibited.



Modello Scala / *Scala Model*
 L.100 mm. \neq 20 X 6
 Art. 04.048.01 H.1000 mm.
 Art. 04.048.02 H.1500 mm.



Modello Mattone / *Brick Model*
 H. 1000 X L.110 mm.
 Art. 04.048.03 \square 12 X 12



H.950 X L.100 mm.
 Art. 04.048.04 \neq 12 X 6
 Art. 04.048.05 \neq 14 X 6



H.1000 x L.160 mm
 Mattone / *Brick*
 Art. 04.048.10 \neq 40 x 8 mm

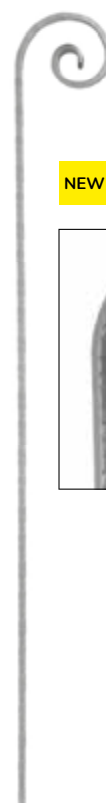

H.1000 x L.120 mm
 Mattone / *Brick*
 Art. 04.048.11 \neq 40 x 8 mm



H.950 X L.100 mm.
 Art. 04.048.06 \square 12 X 12
 Art. 04.048.07 \square 14 X 14



H.950 X L.125 mm.
 Art. 04.048.08 \neq 12 X 6
 Art. 04.048.09 \neq 14 X 6





L.170 mm. □ 10 X 10
Art. 04.049 H. 720 mm.
Art. 04.050 H. 820 mm.
Art. 04.051 H. 900 mm.
Art. 04.052 H.1000 mm.

L.170 mm. □ 12 X 12
Art. 04.053 H. 720 mm.
Art. 04.054 H. 820 mm.
Art. 04.055 H. 900 mm.
Art. 04.056 H.1000 mm.



L.115 mm. □ 12 X 12
Art. 04.056.01 H. 650 mm.
Art. 04.056.02 H. 720 mm.
Art. 04.056.03 H.1200 mm.

L.115 mm. □ 14 X 14
Art. 04.056.04 H. 650 mm.
Art. 04.056.05 H. 720 mm.
Art. 04.056.06 H.1200 mm.



Martellato / Hammered
 L.90 mm. □ 12 X 12
Art. 04.056.07 H. 650 mm.
Art. 04.056.08 H. 720 mm.
Art. 04.056.09 H.1200 mm.

L.90 mm. □ 14 X 14
Art. 04.056.10 H. 650 mm.
Art. 04.056.11 H. 720 mm.
Art. 04.056.12 H.1200 mm.



H.520 X L.200 mm.
Art. 04.056.13 □ 12 X 12
Art. 04.056.17 □ 14 X 14
Art. 04.056.18 □ 16 X 16



H.690 X L.260 mm.
Art. 04.056.14 □ 20 X 20



L.235 mm. ≧ 20 X 6
Art. 04.056.15 H.660 mm.
Art. 04.056.16 H.760 mm.



Liscio / Smooth
 H.600 x L.290 mm
Art. 04.056.20 □ 12



L.250 mm. □ 12 X 12
Art. 04.057 H. 720 mm.
Art. 04.058 H. 820 mm.
Art. 04.059 H. 900 mm.
Art. 04.060 H. 1200 mm.
Art. 04.061 H. 1500 mm.
Art. 04.062 H. 1800 mm.

L.250 mm. □ 14 X 14
Art. 04.057.01 H. 720 mm.
Art. 04.058.01 H. 820 mm.
Art. 04.059.01 H. 900 mm.
Art. 04.060.01 H.1200 mm.
Art. 04.061.01 H.1500 mm.
Art. 04.062.01 H.1800 mm.

L.250 mm. □ 16 X 16
Art. 04.057.02 H. 720 mm.
Art. 04.058.02 H. 820 mm.
Art. 04.059.02 H. 900 mm.
Art. 04.060.02 H.1200 mm.
Art. 04.061.02 H 1500 mm.
Art. 04.062.02 H 1800 mm.

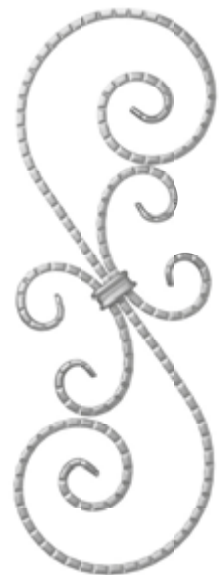

Modello Scala / Scala Model
 H.380 x L.135 mm
Art. 04.062.10 ≧ 12 x 6 mm

NEW



Rigato / Fluted

L.210 mm. □ 12 X 12
 Art. 04.063 H.1000 mm.
 Art. 04.064 H.1200 mm.



Rigato / Fluted

L.210 mm. □ 12 X 12
 Art. 04.065 H.1000 mm.
 Art. 04.066 H.1200 mm.



L.200 mm. □ 12 X 12
 Art. 04.067 H. 950 mm.
 Art. 04.068 H.1200 mm.
 Art. 04.069 H.1500 mm.
 Art. 04.070 H.1800 mm.



L.125 mm. □ 12 X 12
 Art. 04.075 H. 950 mm.
 Art. 04.076 H.1200 mm.
 Art. 04.077 H.1500 mm.
 Art. 04.078 H.1800 mm.



L.125 mm. □ 12 X 12
 Art. 04.083 H. 950 mm.
 Art. 04.084 H.1200 mm.
 Art. 04.085 H.1500 mm.
 Art. 04.086 H.1800 mm.

Liscio / Smooth
 H.950 X L.205 mm.
 Art. 04.090.01 □ 14 X 14

L.200 mm. □ 14 X 14
 Art. 04.071 H. 950 mm.
 Art. 04.072 H.1200 mm.
 Art. 04.073 H.1500 mm.
 Art. 04.074 H.1800 mm.

L.125 mm. □ 14 X 14
 Art. 04.079 H. 950 mm.
 Art. 04.080 H.1200 mm.
 Art. 04.081 H.1500 mm.
 Art. 04.082 H.1800 mm.

L.125 mm. □ 14 X 14
 Art. 04.087 H. 950 mm.
 Art. 04.088 H.1200 mm.
 Art. 04.089 H.1500 mm.
 Art. 04.090 H.1800 mm.

Martellato / Hammered
 H.950 x L.125 mm

Art. 04.090.09 □ 12 X 12 mm



Liscio / Smooth

H.950 mm
 Art. 04.090.10 □ 12
 Art. 04.090.11 □ 14
 Art. 04.090.12 □ 16



L.200 mm. □ 12 X 12
 Art. 04.091 H. 950 mm.
 Art. 04.092 H.1200 mm.
 Art. 04.093 H.1500 mm.
 Art. 04.094 H.1800 mm.



H.950 X L.170 mm.
 Art. 04.095 □ 12 X 12



H.540 X L.115 mm.
 Art. 04.096 □ 10 X 10
 Art. 04.097 □ 12 X 12

Martellato / Hammered

H.540 X L.115 mm.
 Art. 04.098 □ 12 X 12

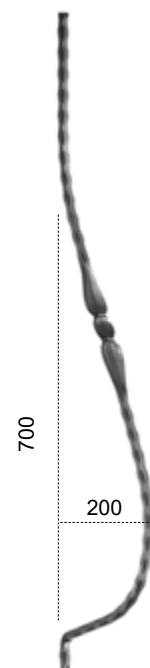

Martellato / Hammered

L.200 mm. □ 12 X 12
 Art. 04.098.01 H. 950 mm.
 Art. 04.098.02 H.1200 mm.
 Art. 04.098.03 H.1500 mm.
 Art. 04.098.04 H.1800 mm.

L.200 mm. □ 14 X 14
 Art. 04.098.05 H. 950 mm.
 Art. 04.098.06 H.1200 mm.
 Art. 04.098.07 H.1500 mm.
 Art. 04.098.08 H.1800 mm.

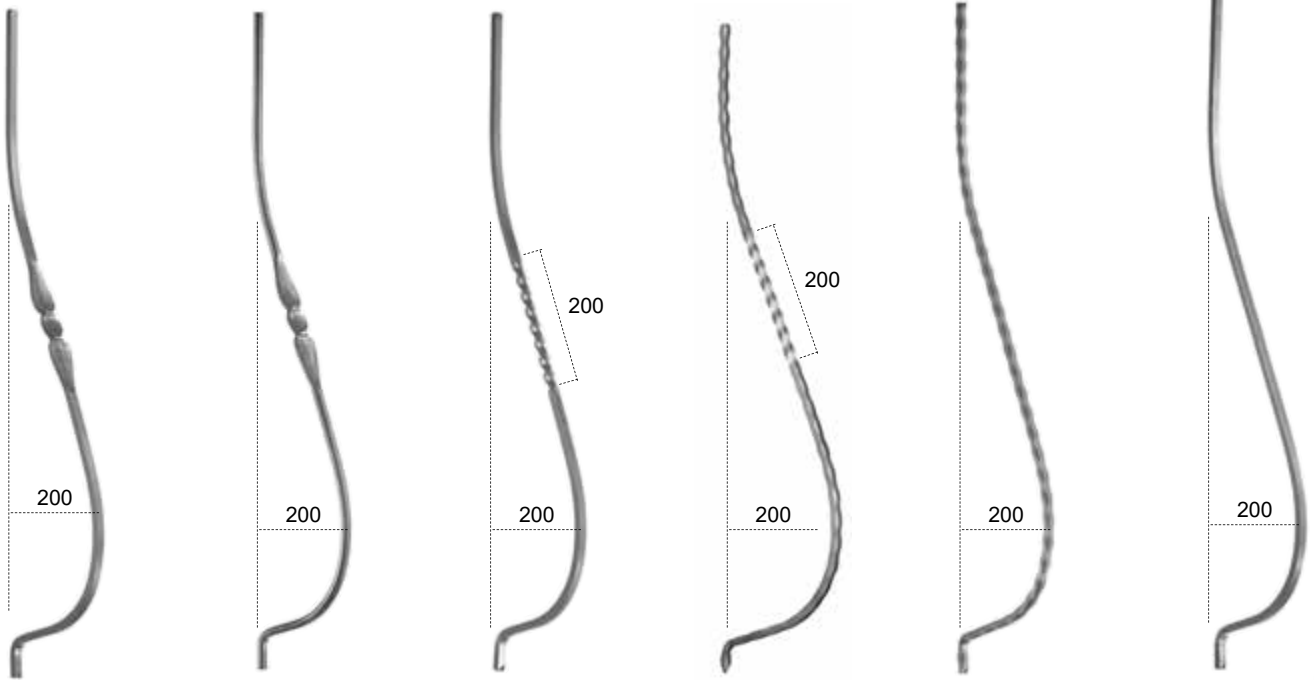

Tondo / Round

- | | |
|---------------------------|---------------------------|
| L.200 mm. □ 12 X 12 | L.200 mm. Ø 14 |
| Art. 04.098.09 H. 950 mm. | Art. 04.098.17 H. 950 mm. |
| Art. 04.098.10 H.1200 mm. | Art. 04.098.18 H.1200 mm. |
| Art. 04.098.11 H.1500 mm. | Art. 04.098.19 H.1500 mm. |
| Art. 04.098.12 H.1800 mm. | Art. 04.098.20 H.1800 mm. |
| L.200 mm. □ 14 X 14 | L.200 mm. Ø 16 |
| Art. 04.098.13 H. 950 mm. | Art. 04.098.21 H. 950 mm. |
| Art. 04.098.14 H.1200 mm. | Art. 04.098.22 H.1200 mm. |
| Art. 04.098.15 H.1500 mm. | Art. 04.098.23 H.1500 mm. |
| Art. 04.098.16 H.1800 mm. | Art. 04.098.24 H.1800 mm. |

Martellato / Hammered

- | |
|------------------------|
| L.200 mm. □ 12 X 12 |
| Art. 04.099 H. 950 mm. |
| Art. 04.100 H.1200 mm. |
| Art. 04.101 H.1500 mm. |
| Art. 04.102 H.1800 mm. |

Martellato / Hammered

- | |
|------------------------|
| L.200 mm. □ 12 X 12 |
| Art. 04.103 H. 950 mm. |
| Art. 04.104 H.1200 mm. |
| Art. 04.105 H.1500 mm. |
| Art. 04.106 H.1800 mm. |

- | |
|---------------------------|
| L.200 mm. □ 12 X 12 |
| Art. 04.106.05 H. 950 mm. |
| Art. 04.106.06 H.1200 mm. |
| Art. 04.106.07 H.1500 mm. |
| Art. 04.106.08 H.1800 mm. |

- | |
|---------------------------|
| L.200 mm. □ 14 X 14 |
| Art. 04.106.01 H. 950 mm. |
| Art. 04.106.02 H.1200 mm. |
| Art. 04.106.03 H.1500 mm. |
| Art. 04.106.04 H.1800 mm. |

- | |
|---------------------------|
| L.200 mm. □ 14 X 14 |
| Art. 04.106.09 H. 950 mm. |
| Art. 04.106.10 H.1200 mm. |
| Art. 04.106.11 H.1500 mm. |
| Art. 04.106.12 H.1800 mm. |



Tondo / Round

- | |
|---------------------------|
| L.200 mm. Ø 14 |
| Art. 04.106.13 H. 950 mm. |
| Art. 04.106.14 H.1200 mm. |
| Art. 04.106.15 H.1500 mm. |
| Art. 04.106.16 H.1800 mm. |
| L.200 mm. Ø 16 |
| Art. 04.106.17 H. 950 mm. |
| Art. 04.106.18 H.1200 mm. |
| Art. 04.106.19 H.1500 mm. |
| Art. 04.106.20 H.1800 mm. |

- | |
|--------------------------------------|
| L.200 mm. Ø 12 |
| Art. 04.106.40 H. 950 mm. |
| Art. 04.106.41 H.1200 mm. NEW |
| Art. 04.106.42 H.1500 mm. |
| Art. 04.106.43 H.1800 mm. |



- Attorcigliato, Martellato e Rigato
Fluted, Hammered and Twisted*
- | |
|--------------------------|
| L.200 mm. □ 14 X 14 |
| Art. 04.106.21 H.950 mm. |



- Martellato / Hammered*
- | |
|--------------------------|
| L.200 mm. □ 12 X 12 |
| Art. 04.106.30 H.950 mm. |



- Martellato / Hammered*
- | |
|--------------------------|
| L.200 mm. □ 12 X 12 |
| Art. 04.106.31 H.950 mm. |



- Martellato / Hammered*
- | |
|------------------------|
| L.200 mm. □ 12 X 12 |
| Art. 04.107 H. 950 mm. |
| Art. 04.108 H.1200 mm. |
| Art. 04.109 H.1500 mm. |
| Art. 04.110 H.1800 mm. |

- | |
|---------------------------|
| L.200 mm. □ 14 X 14 |
| Art. 04.110.01 H. 950 mm. |
| Art. 04.110.02 H.1200 mm. |
| Art. 04.110.03 H.1500 mm. |
| Art. 04.110.04 H.1800 mm. |

Tutte le parti di questo catalogo - foto comprese - sono di proprietà Euro-Fer. La riproduzione, anche parziale, è vietata in ogni forma e con ogni mezzo. / Every part of this catalogue - photos included - is Euro-Fer's property. All forms of copying are strictly prohibited.



L.200 mm. □ 12 X 12
Art. 04.110.05 H. 950 mm.
Art. 04.110.06 H.1200 mm.
Art. 04.110.07 H.1500 mm.
Art. 04.110.08 H.1800 mm.

Martellato / *Hammered*
 L.200 mm. □ 12 X 12
Art. 04.111 H. 950 mm.
Art. 04.112 H.1200 mm.
Art. 04.113 H.1500 mm.
Art. 04.114 H.1800 mm.

L.200 mm. □ 12 X 12
Art. 04.114.05 H. 950 mm.
Art. 04.114.06 H.1200 mm.
Art. 04.114.07 H.1500 mm.
Art. 04.114.08 H.1800 mm.

Martellato / *Hammered*
 L.200 mm. □ 12 X 12
Art. 04.115 H. 950 mm.
Art. 04.116 H.1200 mm.
Art. 04.117 H.1500 mm.
Art. 04.118 H.1800 mm.

L.200 mm. □ 12 X 12
Art. 04.118.05 H. 950 mm.
Art. 04.118.06 H.1200 mm.
Art. 04.118.07 H.1500 mm.
Art. 04.118.08 H.1800 mm.

Forgiato / *Forged*
 H.950 x L.150 mm
Art. 04.118.40 ≙ 13 x 10 mm

L.200 mm. □ 14 X 14
Art. 04.110.09 H. 950 mm.
Art. 04.110.10 H.1200 mm.
Art. 04.110.11 H.1500 mm.
Art. 04.110.12 H.1800 mm.

L.200 mm. □ 14 X 14
Art. 04.114.01 H. 950 mm.
Art. 04.114.02 H.1200 mm.
Art. 04.114.03 H.1500 mm.
Art. 04.114.04 H.1800 mm.

L.200 mm. □ 14 X 14
Art. 04.114.09 H. 950 mm.
Art. 04.114.10 H.1200 mm.
Art. 04.114.11 H.1500 mm.
Art. 04.114.12 H.1800 mm.

L.200 mm. □ 14 X 14
Art. 04.118.01 H. 950 mm.
Art. 04.118.02 H.1200 mm.
Art. 04.118.03 H.1500 mm.
Art. 04.118.04 H.1800 mm.

L.200 mm. □ 14 X 14
Art. 04.118.09 H. 950 mm.
Art. 04.118.10 H.1200 mm.
Art. 04.118.11 H.1500 mm.
Art. 04.118.12 H.1800 mm.



Forgiato / *Forged*
 H.950 x L.150 mm
Art. 04.118.45 ≙ 13 x 10 mm



Liscio / *Smooth*
 H.720 x L.260mm
Art. 04.118.99 Ø 12



H.730 X L.250 mm.
Art. 04.119 ≙ 20 X 6



Modello Scala / *Scala Model*
 H.730 X L.250 mm.
Art. 04.119.01 ≙ 20 X 6



Tondo / *Round*
 H.750 X L.250 mm.
Art. 04.119.02 Ø 14



H.470 X L.180 mm.
Art. 04.119.03 ≙ 20 X 6

NEW



Tondo / *Round*
 H.480 x L.190 mm
Art. 04.119.13 Ø 12
 liscio / *smooth*



H.850 X L.235 mm. Sinistro/Left
Art. 04.119.04 ≙ 20 X 6
 H.950 X L.235 mm. Sinistro/Left
Art. 04.119.06 ≙ 20 X 6



H.850 X L.235 mm. Destro/Right
Art. 04.119.05 ≙ 20 X 6
 H.950 X L.235 mm. Destro/Right
Art. 04.119.07 ≙ 20 X 6



Martellato / Hammered
 H.900 X L.380 mm.
Art. 04.119.08 □ 25 X 25



Martellato / Hammered
 H.750 X L.350 mm.
Art. 04.119.09 □ 12 mm ≙ 12 X 6
Art. 04.119.10 □ 14 mm ≙ 12 X 6
Art. 04.120 □ 16 mm ≙ 16 X 8



Martellato / Hammered
 H.480 X L.220 mm.
Art. 04.120.01 □ 12 mm ≙ 12 X 6
Art. 04.120.02 □ 14 mm ≙ 12 X 6
Art. 04.120.03 □ 16 mm ≙ 16 X 8



Battuto / Wrought
 H.800 X L.305 mm.
Art. 04.120.04 ≙ 25 X 10



H.700 X L.250 mm.
Art. 04.120.05 ≙ 20 X 8



H.730 X L.240 mm.
Art. 04.121 ≙ 20 X 6



Modello Scala / Scala Model
 H.730 X L.240 mm.
Art. 04.121.01 ≙ 20 X 6



Liscio / Smooth
 H.740 X L.250 mm.
Art. 04.140 □ 10 mm



Liscio / Smooth
 H.885 X L.265 mm.
Art. 04.146 Ø 12 mm
Art. 04.146.01 Ø 14 mm
Art. 04.146.02 Ø 16 mm



Liscio / Smooth
 H.770 X L.280 mm.
Art. 04.141 Ø 25 mm



Liscio / Smooth
 H.820 x L.280 mm
Art. 04.141.01 ≙ 25 x 25 mm



Liscio / Smooth
 H.820 x L.280 mm
Art. 04.141.02 ≙ 25 x 25 mm



Rigato / Fluted
 H.550 X L.250 mm.
Art. 04.142 ≙ 16 X 8



Liscio / Smooth
 H.570 X L.160 mm.
Art. 04.143 ≙ 14 X 6
Art. 04.143.01 ≙ 16 X 6



Martellato / Hammered
 H.480 X L.330 mm.
Art. 04.145 ≙ 18 X 10



Gli articoli della Linea Liberty possono includere particolari in ghisa o ferro fuso.
The items of the Liberty Line could contain casting parts.



Foglia
14.203

H.280 x L.210 mm
Art. 04.400 Ø 10 mm
 Sinistro / Left



Foglia
14.202

H.280 x L.210 mm
Art. 04.401 Ø 10 mm
 Destro / Right



Fuori Produzione
 Out of Production

Art. 04.402

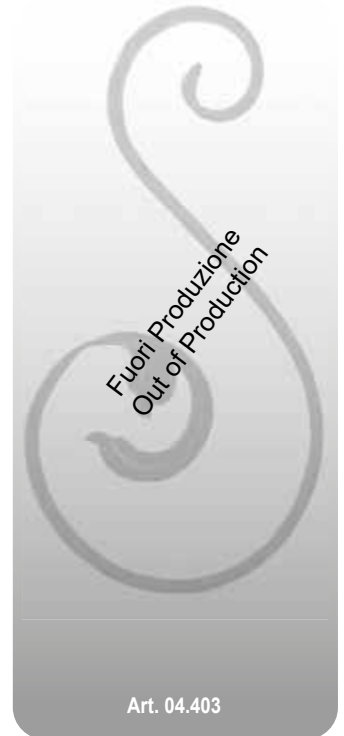

Fuori Produzione
 Out of Production

Art. 04.403



Foglia
14.221

Foglia
14.224

Martellato / *Hammered*
 H.400 x L.250 mm
Art. 04.404 ≠ 16 X 8 mm
 Sinistro / Left

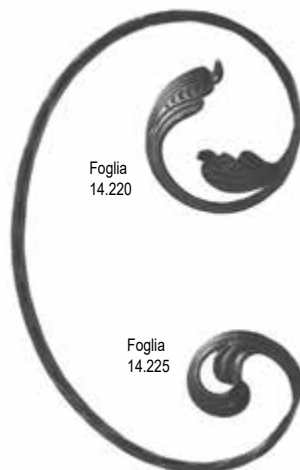

Foglia
14.220

Foglia
14.225

Martellato / *Hammered*
 H.400 x L.250 mm
Art. 04.405 ≠ 16 x 8 mm
 Destro / Right

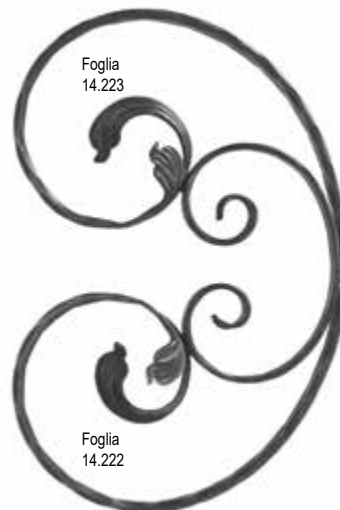

Foglia
14.223

Foglia
14.222

Martellato / *Hammered*
 H.450 x L.300 mm
Art. 04.406 ≠ 16 x 8 mm
 Sinistro / Left



Foglia
14.222

Foglia
14.223

Martellato / *Hammered*
 H.450 x L.300 mm
Art. 04.407 ≠ 16 x 8 mm
 Destro / Right



Foglia
14.225

Foglia
14.221

Martellato / Hammered
H.500 x L.260 mm
Art. 04.408 ≠ 16 x 8 mm
Sinistro / Left



Foglia
14.224

Foglia
14.220

Martellato / Hammered
H.500 x L.260 mm
Art. 04.409 ≠ 16 X 8 mm
Destro / Right

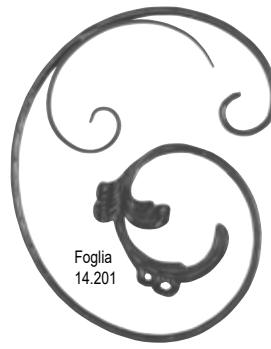

Foglia
14.201

H.370 X L.330 mm.
Art. 04.500 Ø 12 mm

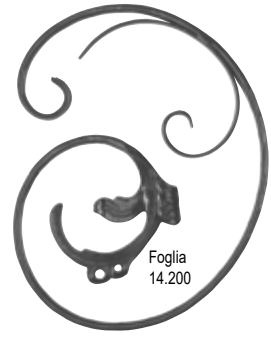

Foglia
14.200

H.370 X L.330 mm.
Art. 04.501 Ø 12 mm



Foglia
14.199

H.460 X L.440 mm.
Art. 04.502 Ø 12 mm



Foglia
14.198

H.460 X L.440 mm.
Art. 04.503 Ø 12 mm



Foglia
14.202

Foglia
14.199

H.620 X L.410 mm.
Art. 04.505 Ø 12 mm

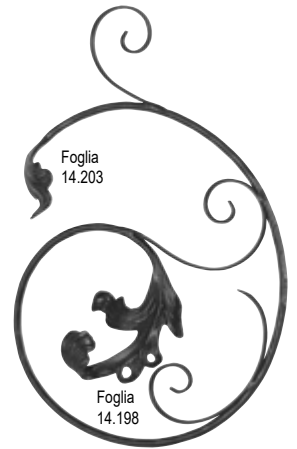

Foglia
14.203

Foglia
14.198

H.620 X L.410 mm.
Art. 04.506 Ø 12 mm

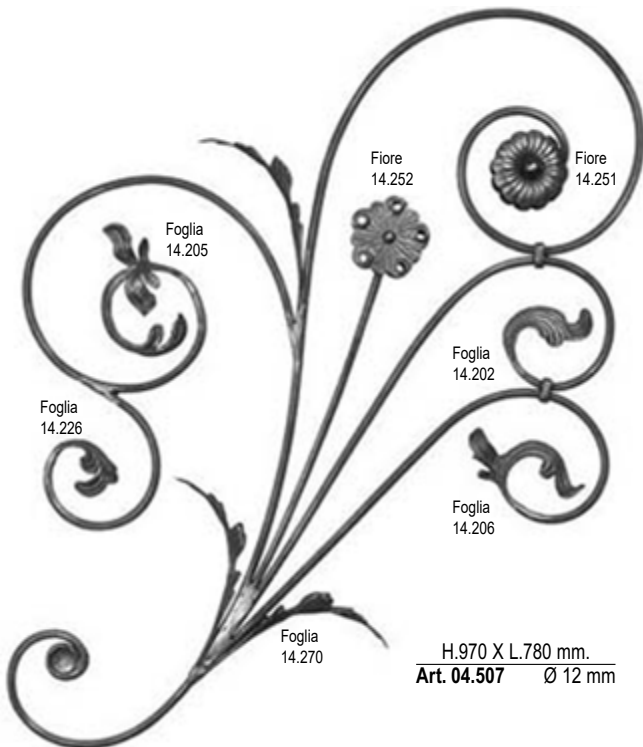

Foglia
14.205

Fiore
14.252

Fiore
14.251

Foglia
14.202

Foglia
14.206

Foglia
14.270

H.970 X L.780 mm.
Art. 04.507 Ø 12 mm

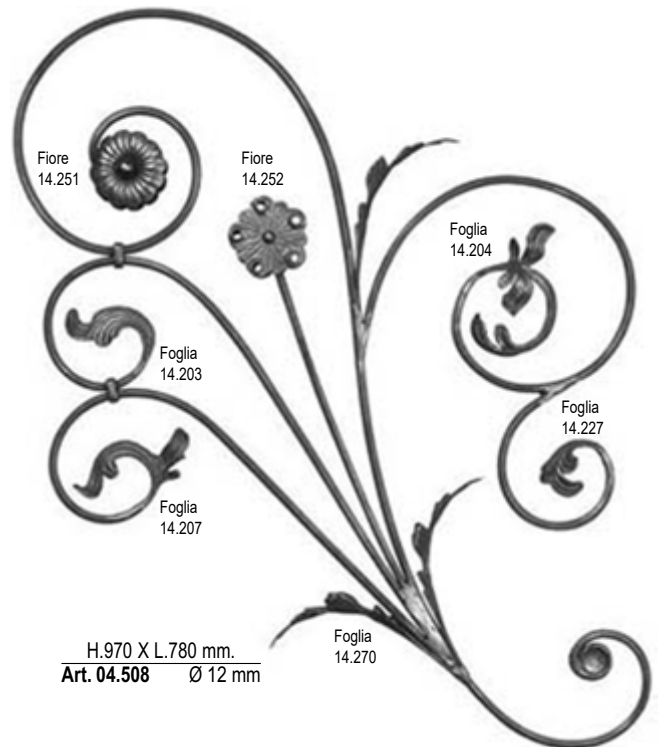

Fiore
14.251

Fiore
14.252

Foglia
14.203

Foglia
14.207

Foglia
14.270

H.970 X L.780 mm.
Art. 04.508 Ø 12 mm

Tutte le parti di questo catalogo - foto comprese - sono di proprietà Euro-Fer. La riproduzione, anche parziale, è vietata in ogni forma e con ogni mezzo. / Every part of this catalogue - photos included - is Euro-Fer's property. All forms of copying are strictly prohibited.

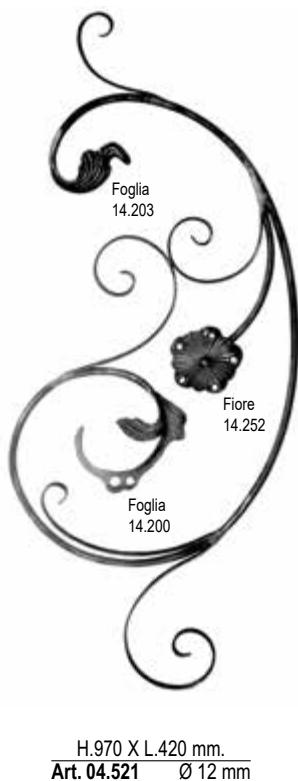
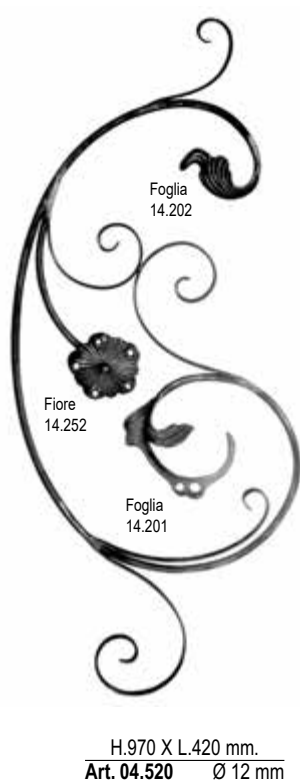
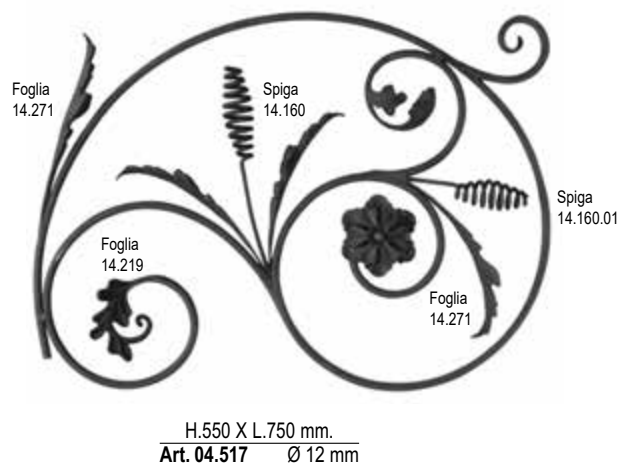
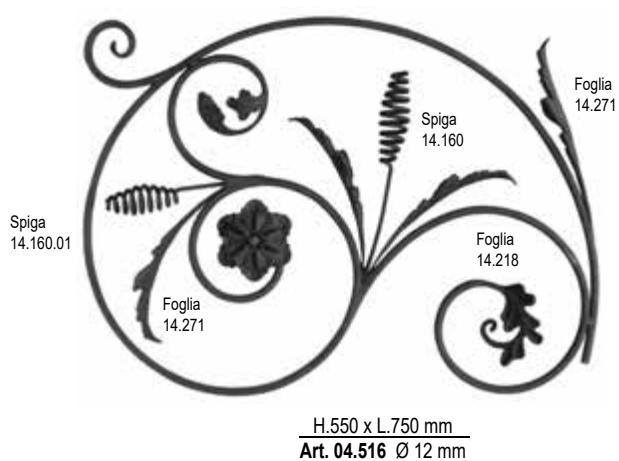
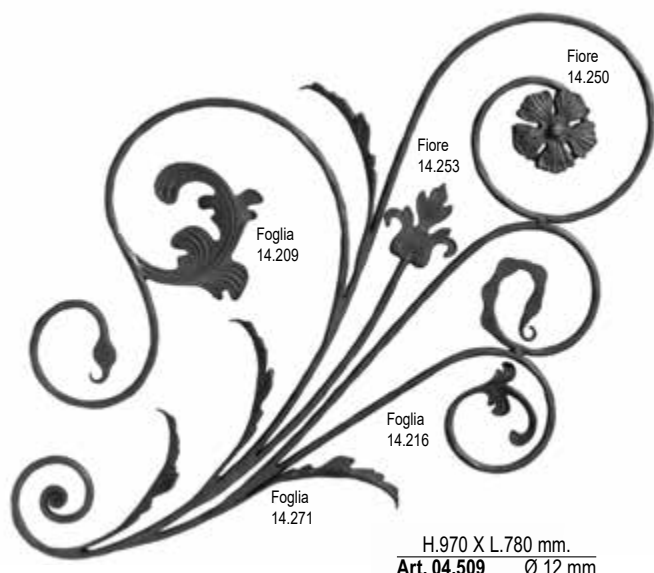



Foglia
14.215



Foglia
14.214

Rigato / Fluted
H.715 x L.190 mm
Art. 04.528 ≙ 16 x 8 mm
Sinistro / Left

Rigato / Fluted
H.715 x L.190 mm
Art. 04.529 ≙ 16 x 8 mm
Destro / Right



Foglia
14.211

Foglia
14.210

Rigato / Fluted
H.370 X L.880 mm.
Art. 04.530 ≙ 16 X 8

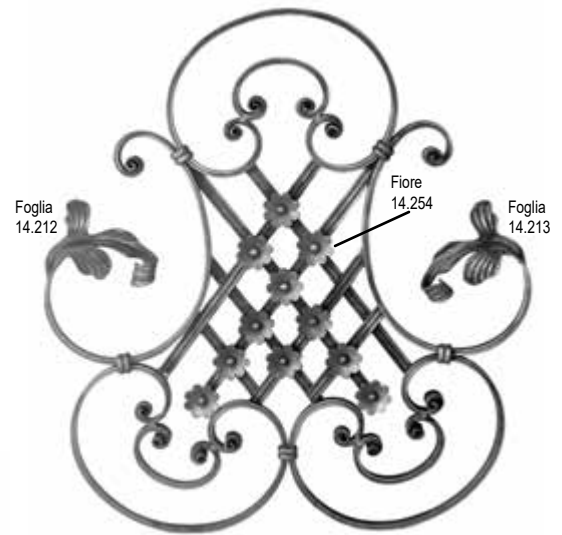

Foglia
14.212

Fiore
14.254

Foglia
14.213

Rigato / Fluted
H.710 X L.640 mm.
Art. 04.531 ≙ 16 X 8

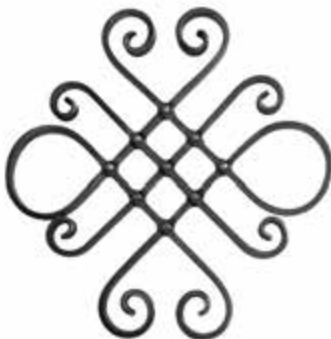

H. 400 X L.400 mm.
Art. 04.534 ≙ 16X8 mm.



H.600 X L.400 mm.
Art. 04.535 ≙ 16X8 mm.



Art. 04.533

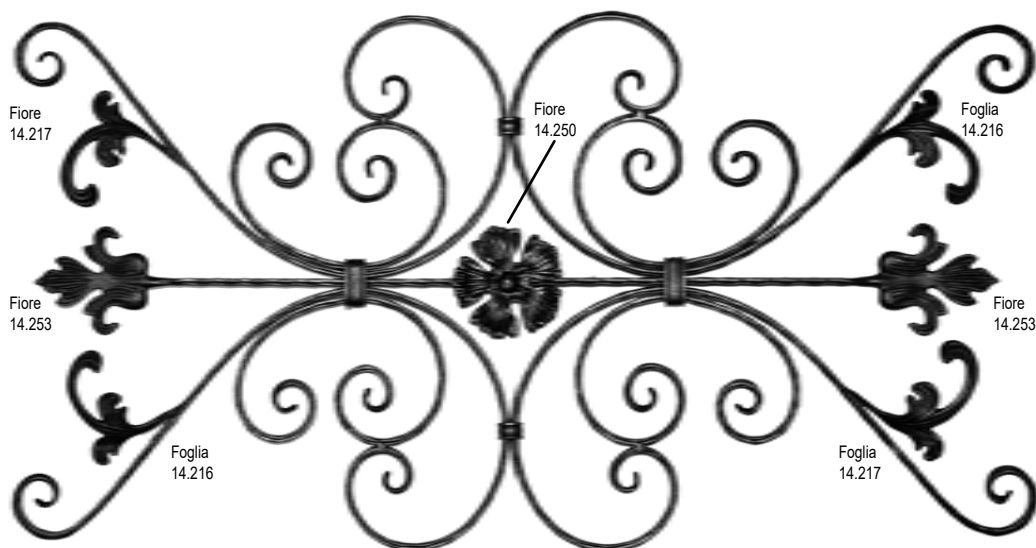

Rigato / Fluted
H.540 x L.1010 mm
Art. 04.536 \neq 20 X 8 mm



Martellato / Hammered
H.440 x L.330 mm
Art. 04.580



Martellato / Hammered
H. 460 X L. 370 mm.
Art. 04.581



Rigato / Fluted
H. 800 X L. 350 mm.
Art. 04.537 \square 12 mm.



Martellato / Hammered
H.900 x L.350 mm
Art. 04.538 \square 12 mm



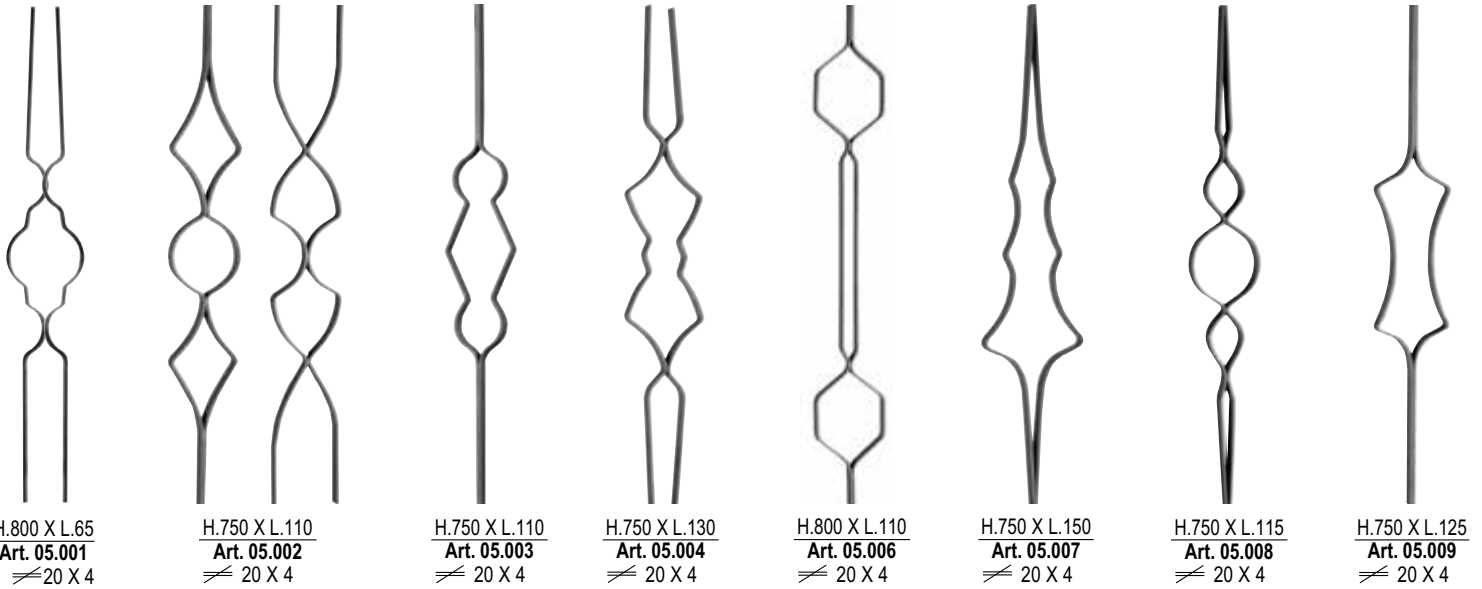

Gli elementi indicati qui sopra sono venduti singolarmente: sono accoppiati a titolo dimostrativo / The elements in the line above are sold separately: they are only in pairs for demonstration purposes

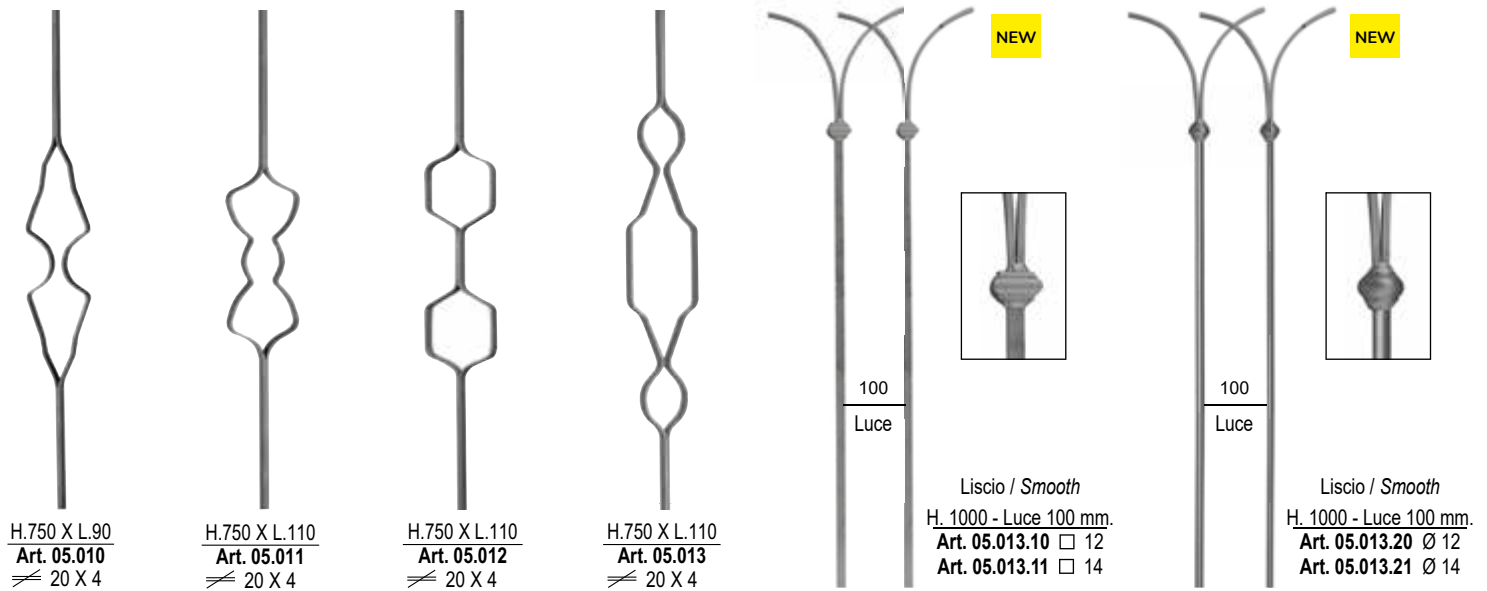

Gli elementi indicati qui sopra sono venduti singolarmente: sono accoppiati a titolo dimostrativo / The elements in the line above are sold separately: they are only in pairs for demonstration purposes

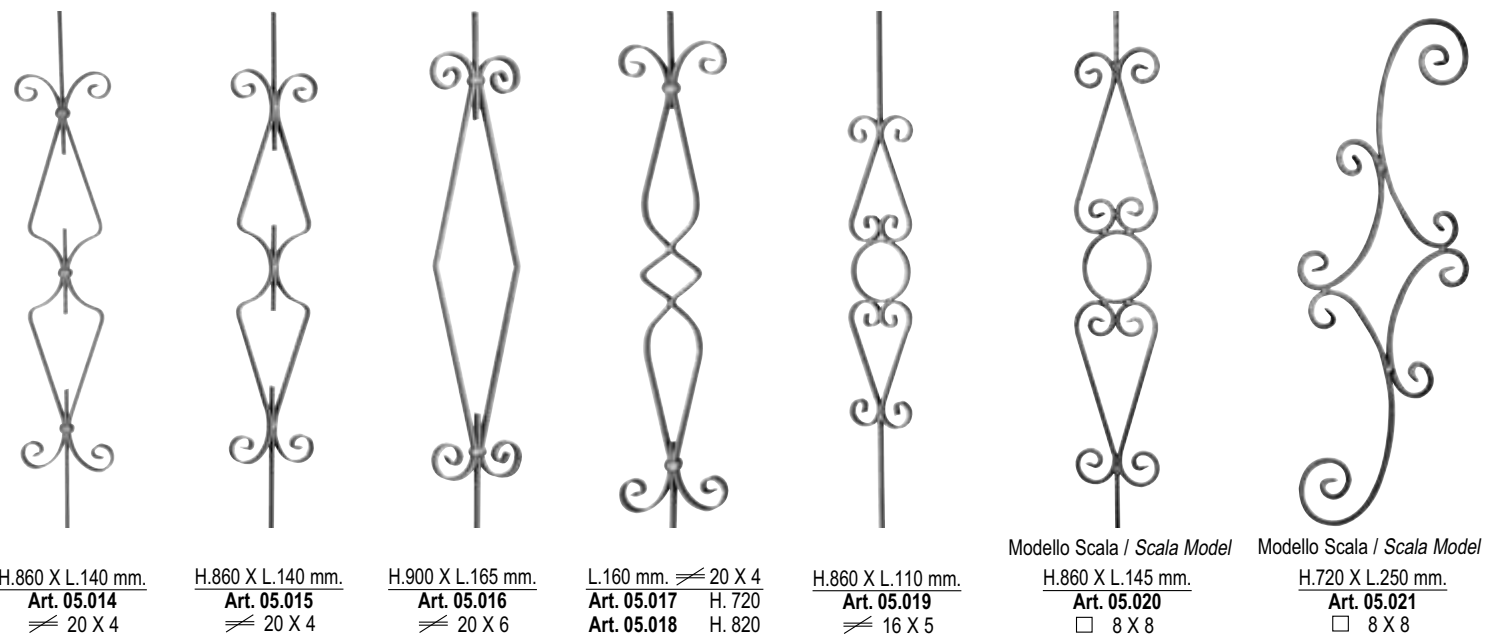

Tutte le parti di questo catalogo - foto comprese - sono di proprietà Euro-Fer. La riproduzione, anche parziale, è vietata in ogni forma e con ogni mezzo. / Every part of this catalogue - photos included - is Euro-Fer's property. All forms of copying are strictly prohibited.



H.720 X L.250 mm.
Art. 05.023
≠ 16 X 4



Tondo / Round
H.870 X L.260 mm.
Art. 05.023.01
Ø 12



H.720 X L.250 mm.
Art. 05.024
≠ 16 X 4



H.720 X L.250 mm.
Art. 05.025
≠ 16 X 4

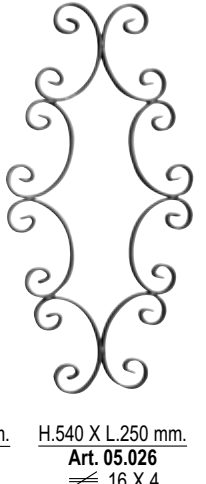

H.540 X L.250 mm.
Art. 05.026
≠ 16 X 4

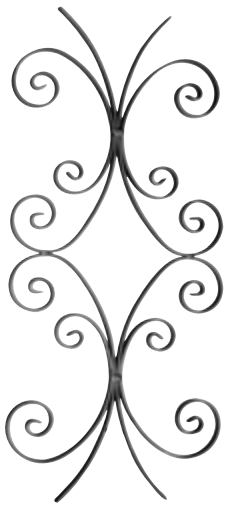

H.720 X L.330 mm.
Art. 05.028
≠ 16 X 4



Ferro Spigolato
Edged Bar
H.950 X L.125 mm.
Art. 05.029
□ 14 X 14

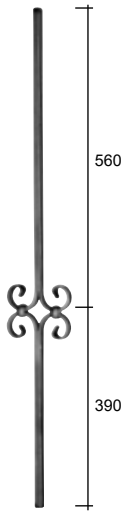

Ferro Spigolato
Edged Bar
H.950 X L.125 mm.
Art. 05.030
□ 14 X 14



Ferro Spigolato
Edged Bar
H.950 X L.125 mm.
Art. 05.031
□ 14 X 14



H.750 X L.200 mm.
Art. 05.032
3 ≠ 16 X 4



H.750 X L.200 mm.
Art. 05.033
3 ≠ 16 X 4



H.750 X L.200 mm.
Art. 05.034
4 ≠ 16 X 4



H.750 X L.200 mm.
Art. 05.035
4 ≠ 16 X 4

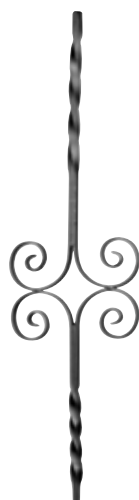

H.750 X L.200 mm.
Art. 05.036
3 ≠ 16 X 4



H.750 X L.200 mm.
Art. 05.037
3 ≠ 16 X 4



H.750 mm.
Art. 05.038 ≠ 16 X 4
Art. 05.039 ≠ 20 X 4

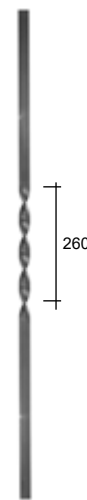

H.950 mm.
Art. 05.043.01
≠ 20 X 6

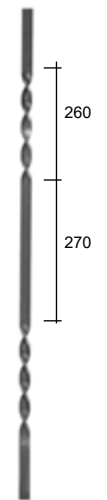

H.950 mm.
Art. 05.043.02
≠ 20 X 6

H.850 mm.
Art. 05.040 ≠ 16 X 4
Art. 05.041 ≠ 20 X 4

H.900 mm.
Art. 05.042 ≠ 16 X 4
Art. 05.043 ≠ 20 X 4

Tutte le parti di questo catalogo - foto comprese - sono di proprietà Euro-Fer. La riproduzione, anche parziale, è vietata in ogni forma e con ogni mezzo. / Every part of this catalogue - photos included - is Euro-Fer's property. All forms of copying are strictly prohibited.

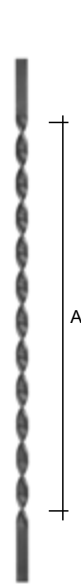

H.720 mm.
Art. 05.043.03
≠ 20 X 6
A = 550 mm.
H.950 mm.
Art. 05.043.04
≠ 20 X 6
A = 700 mm.

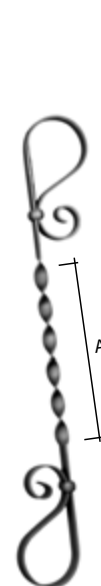

H. 730 X L.90 mm.
Art. 05.044
≠ 20 x 4 mm
A= 330 mm.

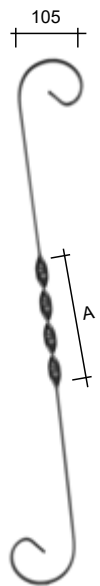

H.350 mm. - A = 100 mm.
Art. 05.044.01 ≠ 20 X 5
H.650 mm. - A = 220 mm.
Art. 05.044.02 ≠ 20 X 5
H.850 mm. - A = 220 mm.
Art. 05.044.03 ≠ 20 X 5
H.950 mm. - A = 220 mm.
Art. 05.044.04 ≠ 20 X 5



H.950 mm.
Art. 05.045 □12
Art. 05.045.01 □14
Art. 05.045.02 □16



H.950 mm.
Art. 05.046 □12
Art. 05.046.01 □14
Art. 05.046.02 □16



H.750 mm.
Art. 05.047 □8
Art. 05.048 □10
Art. 05.049 □12
Art. 05.050 □14
Art. 05.051 □16



H.950 mm.
Art. 05.062 □12



H.950 mm.
Art. 05.063 □12



H.950 X L.110 mm.
Art. 05.064
□12 ≠12 X 4



H.950 X L.165 mm.
Art. 05.065
□12 ≠12 X 6



H.950 X L.165 mm.
Art. 05.066
□12 ≠12 X 6

H.1200 mm.
Art. 05.045.03 □12
Art. 05.045.04 □14
Art. 05.045.05 □16

H.1500 mm.
Art. 05.045.06 □12
Art. 05.045.07 □14
Art. 05.045.08 □16

H.850 mm.
Art. 05.052 □8
Art. 05.053 □10
Art. 05.054 □12
Art. 05.055 □14
Art. 05.056 □16

H.950 mm.
Art. 05.057 □8
Art. 05.058 □10
Art. 05.059 □12
Art. 05.060 □14
Art. 05.061 □16



PANNELLI LISCI E PALETTI PER RECINZIONI
PLAIN PANEL UNITS AND STAKES FOR FENCES



H.950 X L.170 mm.
Art. 05.067
 □12 ≙12 X 6



H.950 X L.170 mm.
Art. 05.068
 □12 ≙12 X 6



H.950 X L.110 mm.
Art. 05.069
 □12 ≙12 X 6



H.950 X L.140 mm.
Art. 05.070
 □12 ≙12 X 6



H.950 X L.140 mm.
Art. 05.071
 □12 ≙12 X 6



H.950 X L.155 mm.
Art. 05.071.01
 □12 ≙12 X 6
 H.950 X L.155 mm.
Art. 05.071.02
 □14 ≙14 X 6



H.950 X L.155 mm.
Art. 05.071.03
 □12 ≙12 X 6
 H.950 X L.155 mm.
Art. 05.071.04
 □14 ≙14 X 6

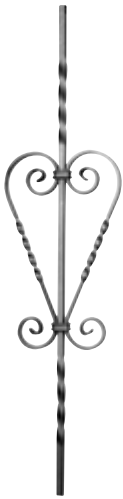

H.950 X L.220 mm.
Art. 05.072
 □12 ≙12 X 6



H.950 X L.180 mm.
Art. 05.073
 □12 ≙12 X 6



H.950 X L.220 mm.
Art. 05.074
 □12 ≙12 X 6

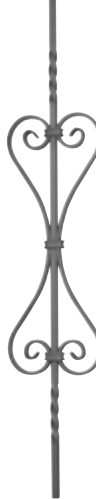

H.950 X L.170 mm.
Art. 05.075
 □12 ≙12 X 6



H.950 X L.180 mm.
Art. 05.076
 □12 ≙12 X 6



H.1200 X L.185 mm
Art. 05.076.01
 □16 ≙16 X 4



H.950 x L.180 mm
Art. 05.076.02
 □12 mm ≙12 x 6



H.950 X L.220 mm.
Art. 05.077
 □12 ≙12 X 6



H.950 X L.240 mm.
Art. 05.078
 □12 ≙12 X 6



H.950 X L.150 mm.
Art. 05.079
 □12 ≙12 X 6



H.950 X L.220 mm.
Art. 05.080
 □12 ≙12 X 6



H.950 X L.150 mm.
Art. 05.081
 □12 ≙12 X 6



H.950 x L.100 mm
Art. 05.081.50 □14



H.950 X L.220 mm.
Art. 05.082
 □12 ≙12 X 6

Tutte le parti di questo catalogo - foto comprese - sono di proprietà Euro-Fer. La riproduzione, anche parziale, è vietata in ogni forma e con ogni mezzo. / Every part of this catalogue - photos included - is Euro-Fer's property. All forms of copying are strictly prohibited.

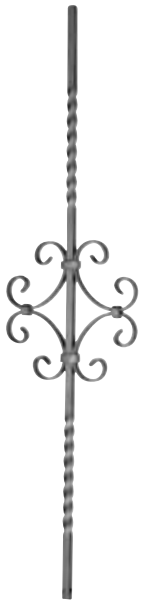

H.950 X L.210 mm.
Art. 05.083
 □12 ≙12 X 4

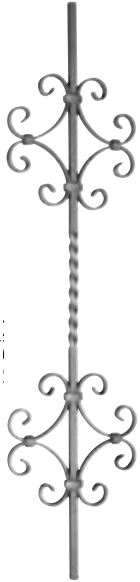

H.950 X L.210 mm.
Art. 05.084
 □12 ≙12 X 4



H.950 X L.270 mm.
Art. 05.085
 □12 ≙12 X 6

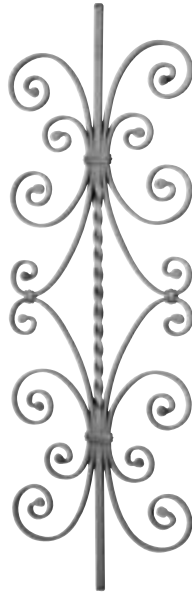

H.950 X L.300 mm.
Art. 05.086
 □12 ≙12 X 6



H.950 X L.220 mm.
Art. 05.087
 □12 ≙12 X 6

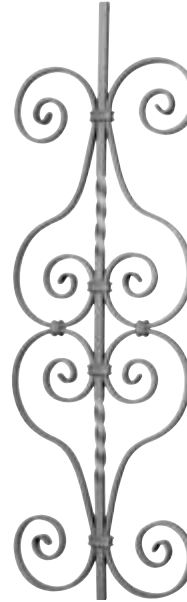

H.950 X L.275 mm.
Art. 05.088
 □12 ≙12 X 6



H.950 X L.180 mm.
Art. 05.088.01
 □12 ≙12 X 6

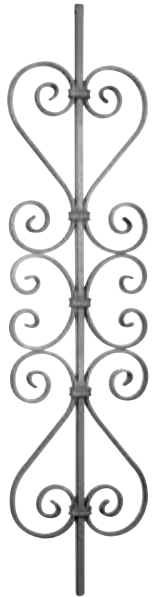

H.950 X L.220 mm.
Art. 05.089
 □12 ≙12 X 6



NEW



Liscio / Smooth
 H. 950 X L. 72 mm.
Art. 05.089.10
 □ 12

NEW



Liscio / Smooth
 H. 950 X L. 72 mm.
Art. 05.089.11
 □ 12



PANNELLI LISCI E PALETTI PER RECINZIONI
PLAIN PANEL UNITS AND STAKES FOR FENCES



H.950 X L.190 mm.
Art. 05.090
 □12 ≙ 12 X 6



H.950 X L.190 mm.
Art. 05.091
 □12 ≙ 12 X 6



H.950 X L.100 mm.
Art. 05.092
 ≙ 40 X 4



H.950 X L.100 mm.
Art. 05.093
 ≙ 40 X 4

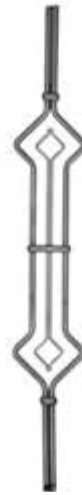

Tondo / Round
 H.950 X L.130 mm.
Art. 05.094 ØØ12



Tondo / Round
 H.950 X L.130 mm.
Art. 05.094.01 ØØ12



Tondo / Round
 H.950 X L.130 mm.
Art. 05.094.02 ØØ12



Tondo / Round
 H.950 X L.270 mm.
Art. 05.094.03 ØØ12



Tondo / Round
 H.900 X L.360 mm.
Art. 05.094.04 Ø14



Tondo / Round
 H.900 X L.360 mm.
Art. 05.094.05 Ø14



H.950 X L.125 mm.
Art. 05.095 □ 12



H.800 X L.100 mm.
Art. 05.096 □ 8
Art. 05.097 □ 10
 H.950 X L.100 mm.
Art. 05.098 □ 8
Art. 05.099 □ 10



H.800 X L.100 mm.
Art. 05.100 □ 8
Art. 05.101 □ 10
 H.950 X L.100 mm.
Art. 05.102 □ 8
Art. 05.103 □ 10



H.800 X L.160 mm.
Art. 05.104 □ 8
 H.950 X L.160 mm.
Art. 05.105 □ 8



H.800 X L.110 mm.
Art. 05.106 □ 10



H.800 X L.200 mm.
Art. 05.107 □ 8



H.800 X L.260 mm.
Art. 05.108 □ 8



H.800 X L.140 mm.
Art. 05.109 □ 8
 H.950 X L.140 mm.
Art. 05.110 □ 8



H.800 X L.200 mm.
Art. 05.111 □ 8
 H.950 X L.200 mm.
Art. 05.112 □ 8



H.800 X L.140 mm.
Art. 05.113 □ 8
 H.950 X L.140 mm.
Art. 05.114 □ 8



H.950 X L.240 mm.
Art. 05.115
 □12 ≙ 12 X 6

Tutte le parti di questo catalogo - foto comprese - sono di proprietà Euro-Fer. La riproduzione, anche parziale, è vietata in ogni forma e con ogni mezzo. / Every part of this catalogue - photos included - is Euro-Fer's property. All forms of copying are strictly prohibited.



H.950 X L.160 mm.
Art. 05.116
□ 12 ≠ 12 X 6



H.820 X L.215 mm.
Art. 05.117 □ 8
H.950 X L.215 mm.
Art. 05.118 □ 8



H.820 X L.205 mm.
Art. 05.119 □ 8
H.950 X L.205 mm.
Art. 05.120 □ 8



Art. 05.121



H.840 X L.150 mm.
Art. 05.122
≠ 12 X 6



Rigato / Fluted
H.950 x L.240 mm
Art. 05.122.50
□ 12 mm ≠ 12 x 6



Rigato / Fluted
H.950 x L.240 mm
Art. 05.122.51
□ 12 mm ≠ 12 x 6



Liscio / Smooth
H.950 mm
Art. 05.123 □ 12 mm
Art. 05.123.01 □ 14 mm
Art. 05.123.ES □ 12 mm
Art. 05.123.01.ES □ 14 mm
Art. 05.123.02 □ 16 mm
Art. 05.123.02.ES □ 16 mm

.ES = "Modello España"
.ES = "España Model"

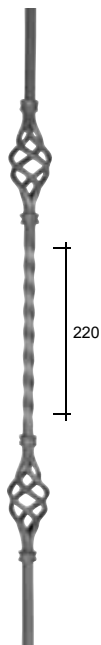

Liscio / Smooth
H.950 mm
Art. 05.124 □ 12 mm
Art. 05.124.01 □ 14 mm
Art. 05.124.ES □ 12 mm
Art. 05.124.01.ES □ 14 mm
Art. 05.124.06 □ 16 mm
Art. 05.124.06.ES □ 16 mm



Liscio / Smooth
H.950 mm
Art. 05.124.02 □ 12 mm
H.950 mm
Art. 05.124.03 □ 14 mm
H.950 mm
Art. 05.124.07 □ 16 mm



Liscio / Smooth
H.950 mm
Art. 05.124.04 □ 12 mm
H.950 mm
Art. 05.124.05 □ 14 mm
H.950 mm
Art. 05.124.08 □ 16 mm



H.950 X L.150 mm.
Art. 05.125
□ 12 ≠ 12 X 6



H.950 X L.150 mm.
Art. 05.126
□ 12 ≠ 12 X 6



H.950 X L.220 mm.
Art. 05.127
□ 12 ≠ 12 X 6



H.950 X L.140 mm.
Art. 05.128
 □ 12 ≧ 12 X 6



H.950 X L.205 mm.
Art. 05.129
 □ 12 ≧ 12 X 6



H.950 X L.170 mm.
Art. 05.130
 □ 12 ≧ 12 X 6



H.950 X L.170 mm.
Art. 05.131
 □ 12 ≧ 12 X 6



H.950 X L.230 mm.
Art. 05.132
 □ 12 ≧ 12 X 6

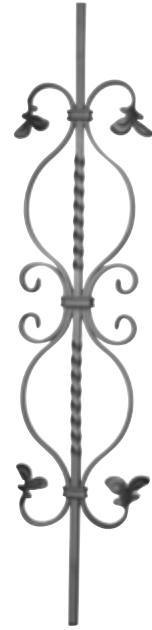

H.950 X L.185 mm.
Art. 05.133
 □ 12 ≧ 12 X 6



H.950 X L.215 mm.
Art. 05.134
 □ 12 ≧ 12 X 6



H.950 X L.215 mm.
Art. 05.135
 □ 12 ≧ 12 X 6

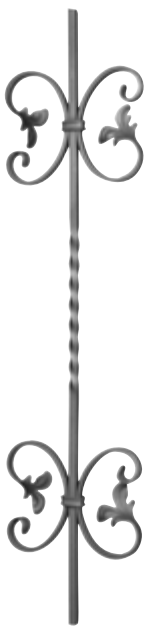

H.950 X L.215 mm.
Art. 05.136
 □ 12 ≧ 12 X 6



Liscio / Smooth
 H.950 x L.235 mm
Art. 05.136.01
 □ 12 mm ≧ 12 x 6 mm



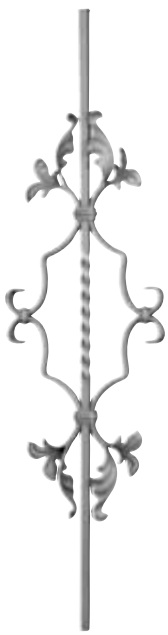

H.950 X L.250 mm.
Art. 05.137
 □ 12 ≙ 12 X 6



H.950 X L.250 mm.
Art. 05.138
 □ 12 ≙ 12 X 6



H.950 X L.170 mm.
Art. 05.139
 □ 12 ≙ 12 X 6



H.950 X L.170 mm.
Art. 05.140
 □ 12 ≙ 12 X 6



H.950 X L.260 mm.
Art. 05.141
 □ 12 ≙ 12 X 6
Art. 05.141.02
 □ 14 ≙ 14 X 6



H.950 X L.230 mm.
Art. 05.141.01
 □ 12 ≙ 12 X 6
Art. 05.141.03
 □ 14 ≙ 14 X 6



Liscio / Smooth
 H.950 x L.280 mm
Art. 05.141.04
 □ 12 ≙ 12 x 6

PP
 pallina piccola
 small ball
 petite boule



H.860 X L.350 mm.
Art. 05.142 ≙ 12 X 6
Art. 05.142.04 ≙ 14 X 6
Art. 05.142.05 ≙ 16 X 8
 Mod. Scala / *Scala Model*
Art. 05.142.06 ≙ 12 X 6
Art. 05.142.07 ≙ 14 X 6
Art. 05.142.08 ≙ 16 X 8



H.860 X L.350 mm.
Art. 05.142.01 ≙ 12 X 6
Art. 05.142.09 ≙ 14 X 6
Art. 05.142.10 ≙ 16 X 8
 Mod. Scala / *Scala Model*
Art. 05.142.11 ≙ 12 X 6
Art. 05.142.12 ≙ 14 X 6
Art. 05.142.13 ≙ 16 X 8



H.950 X L.175 mm.
Art. 05.142.02 □ 12
 H.950 X L.175 mm.
Art. 05.142.03 □ 14



H.950 X L.260 mm.
Art. 05.143
 □ 12 ≙ 12 X 6

PANNELLI LISCI E PALETTI PER RECINZIONI
PLAIN PANEL UNITS AND STAKES FOR FENCES

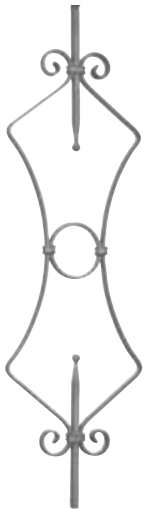

H.950 X L.260 mm.
Art. 05.144
 □ 12 ≧ 12 X 6



H.950 X L.260 mm.
Art. 05.145
 □ 12 ≧ 12 X 6

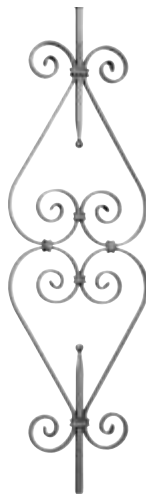

H.950 X L.260 mm.
Art. 05.146
 □ 12 ≧ 12 X 6



Art. 05.147



H.950 X L.290 mm.
Art. 05.148
 □ 12 ≧ 12 X 6



H.950 X L.205 mm.
Art. 05.149
 □ 12 ≧ 12 X 6



H.950 X L.140 mm.
Art. 05.149.01
 □ 12 ≧ 12 X 6



H.950 X L.190 mm.
Art. 05.150
 □ 12 ≧ 12 X 6



H.950 X L.145 mm.
Art. 05.150.01
 □ 12 ≧ 12 X 6
Art. 05.150.02
 □ 14 ≧ 14 X 6



H.950 X L.95 mm.
Art. 05.151
 □ 12 ≧ 12 X 6



H.950 X L.210 mm.
Art. 05.152
 □ 12 ≧ 12 X 6



H.950 X L.150 mm.
Art. 05.152.01 □ 8



H.950 X L.205 mm.
Art. 05.153
 □ 12 ≧ 12 X 6

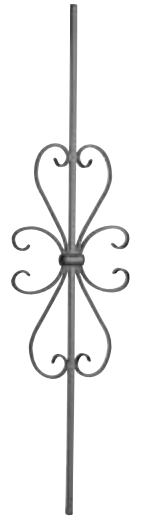

H.950 X L.225 mm.
Art. 05.153.01
 □ 12 ≧ 12 X 6



H.950 X L.220 mm.
Art. 05.154
 □ 12 ≧ 12 X 6



H.950 X L.230 mm.
Art. 05.154.01
 □ 12 ≧ 12 X 6
Art. 05.154.08
 □ 14 ≧ 14 X 6



H.950 X L.185 mm.
Art. 05.154.02
 □ 14 ≧ 14 X 6



H.950 X L.200 mm.
Art. 05.154.03
 □ 12 ≧ 12 X 6
Art. 05.154.09
 □ 14 ≧ 14 X 6



H.950 X L.220 mm.
Art. 05.154.04
 □ 12 ≧ 12 X 6
Art. 05.154.10
 □ 16 ≧ 16 X 8



H.950 X L.205 mm.
Art. 05.154.05
 □ 12 ≧ 12 X 6
Art. 05.154.11
 □ 16 ≧ 16 X 8



H.950 X L.245 mm.
Art. 05.154.06
 □ 12 ≧ 12 X 6

Tutte le parti di questo catalogo - foto comprese - sono di proprietà Euro-Fer. La riproduzione, anche parziale, è vietata in ogni forma e con ogni mezzo. / Every part of this catalogue - photos included - is Euro-Fer's property. All forms of copying are strictly prohibited.



H.830 X L.280 mm.
Art. 05.154.07
≠ 16 X 6



Fuori Produzione
Out of Production

Art. 05.154.12



Fuori Produzione
Out of Production

Art. 05.154.13



Fuori Produzione
Out of Production

Art. 05.154.14



Fuori Produzione
Out of Production

Art. 05.154.15



Liscio / Smooth
H.900 x L.275 mm
Art. 05.154.16
≠ 20 x 6 mm



Rigato / Fluted
H.950 x L.190 mm
Art. 05.154.17
≠ 16 x 8 mm



Martellato / Hammered
H.950 x L.230 mm
Art. 05.154.18
≠ 16 x 8 mm



Martellato / Hammered
H.950 x L.230 mm
Art. 05.154.19
≠ 16 x 8 mm



Liscio / Smooth
H.950 x L.180 mm
Art. 05.154.20 □ 12 mm
Con fiori su ambo i lati /
Flowers on both sides



Liscio / Smooth
H.950 mm

- Art. 05.154.100 □ 12 mm
- Art. 05.154.101 □ 14 mm
- Art. 05.154.102 □ 16 mm
- Art. 05.154.103 □ 18 mm
- Art. 05.154.104 □ 20 mm



Liscio / Smooth
H.950 mm

- Art. 05.154.200 Ø 12 mm
- Art. 05.154.201 Ø 14 mm
- Art. 05.154.202 Ø 16 mm
- Art. 05.154.203 Ø 18 mm
- Art. 05.154.204 Ø 20 mm

PANNELLI LISCI E PALETTI PER RECINZIONI
PLAIN PANEL UNITS AND STAKES FOR FENCES

← Punta a matita /
Pencil Point

← Punta a piramide →
Pyramid Point

Tondo / Round

H.950 mm.

- Art. 05.155 Ø 12
- Art. 05.156 Ø 14
- Art. 05.157 Ø 16
- Art. 05.158 Ø 18
- Art. 05.159 Ø 20

H.1000 mm.

- Art. 05.160 Ø 12
- Art. 05.161 Ø 14
- Art. 05.162 Ø 16
- Art. 05.163 Ø 18
- Art. 05.164 Ø 20

H.1200 mm.

- Art. 05.165 Ø 12
- Art. 05.166 Ø 14
- Art. 05.167 Ø 16
- Art. 05.168 Ø 18
- Art. 05.169 Ø 20

H.1500 mm.

- Art. 05.170 Ø 12
- Art. 05.171 Ø 14
- Art. 05.172 Ø 16
- Art. 05.173 Ø 18
- Art. 05.174 Ø 20

H.950 mm.

- | | |
|------------------|------------------|
| Art. 05.175 □ 12 | Art. 05.193 □ 12 |
| Art. 05.176 □ 14 | Art. 05.194 □ 14 |
| Art. 05.177 □ 16 | Art. 05.195 □ 16 |
| Art. 05.178 □ 18 | Art. 05.196 □ 18 |
| Art. 05.179 □ 20 | Art. 05.197 □ 20 |
| Art. 05.180 □ 25 | Art. 05.198 □ 25 |
| Art. 05.181 □ 30 | Art. 05.199 □ 30 |
| Art. 05.182 □ 35 | Art. 05.200 □ 35 |
| Art. 05.183 □ 40 | Art. 05.201 □ 40 |

H.1200 mm.

- | | |
|------------------|------------------|
| Art. 05.184 □ 12 | Art. 05.202 □ 12 |
| Art. 05.185 □ 14 | Art. 05.203 □ 14 |
| Art. 05.186 □ 16 | Art. 05.204 □ 16 |
| Art. 05.187 □ 18 | Art. 05.205 □ 18 |
| Art. 05.188 □ 20 | Art. 05.206 □ 20 |
| Art. 05.189 □ 25 | Art. 05.207 □ 25 |
| Art. 05.190 □ 30 | Art. 05.208 □ 30 |
| Art. 05.191 □ 35 | Art. 05.209 □ 35 |
| Art. 05.192 □ 40 | Art. 05.210 □ 40 |

H.1000 mm.

- | | |
|------------------|------------------|
| Art. 05.184 □ 12 | Art. 05.202 □ 12 |
| Art. 05.185 □ 14 | Art. 05.203 □ 14 |
| Art. 05.186 □ 16 | Art. 05.204 □ 16 |
| Art. 05.187 □ 18 | Art. 05.205 □ 18 |
| Art. 05.188 □ 20 | Art. 05.206 □ 20 |
| Art. 05.189 □ 25 | Art. 05.207 □ 25 |
| Art. 05.190 □ 30 | Art. 05.208 □ 30 |
| Art. 05.191 □ 35 | Art. 05.209 □ 35 |
| Art. 05.192 □ 40 | Art. 05.210 □ 40 |

H.1500 mm.

- | | |
|------------------|------------------|
| Art. 05.184 □ 12 | Art. 05.202 □ 12 |
| Art. 05.185 □ 14 | Art. 05.203 □ 14 |
| Art. 05.186 □ 16 | Art. 05.204 □ 16 |
| Art. 05.187 □ 18 | Art. 05.205 □ 18 |
| Art. 05.188 □ 20 | Art. 05.206 □ 20 |
| Art. 05.189 □ 25 | Art. 05.207 □ 25 |
| Art. 05.190 □ 30 | Art. 05.208 □ 30 |
| Art. 05.191 □ 35 | Art. 05.209 □ 35 |
| Art. 05.192 □ 40 | Art. 05.210 □ 40 |

Martellato / Hammered

H.950 mm.

- Art. 05.211 □ 12
- Art. 05.212 □ 14
- Art. 05.213 □ 16
- Art. 05.214 □ 18
- Art. 05.215 □ 20

H.1000 mm.

- Art. 05.216 □ 12
- Art. 05.217 □ 14
- Art. 05.218 □ 16
- Art. 05.219 □ 18
- Art. 05.220 □ 20

H.1200 mm.

- Art. 05.221 □ 12
- Art. 05.222 □ 14
- Art. 05.223 □ 16
- Art. 05.224 □ 18
- Art. 05.225 □ 20

H.1500 mm.

- Art. 05.226 □ 12
- Art. 05.227 □ 14
- Art. 05.228 □ 16
- Art. 05.229 □ 18
- Art. 05.230 □ 20

Tubo / Tube

H.900 x L.140 mm

Art. 05.229.01 Ø 20 mm

H.1150 x L.140 mm

Art. 05.229.02 Ø 20 mm

H.1475 x L.140 mm

Art. 05.229.03 Ø 20 mm

H.1800 x L.140 mm

Art. 05.229.04 Ø 20 mm

206

Pieno / Solid

H.1000 X L.124 mm.

Art. 05.230.01 Ø 12

H.1000 X L.128 mm.

Art. 05.230.02 Ø 14

H.1000 X L.124 mm.

Art. 05.230.03 □ 12

H.1000 X L.128 mm.

Art. 05.230.04 □ 14

Pieno / Solid

H.1000 X L.230 mm.

Art. 05.230.05 □ 12

H.1000 X L.234 mm.

Art. 05.230.06 □ 14

H.1000 X L.230 mm.

Art. 05.230.07 Ø 12

H.1000 X L.234 mm.

Art. 05.230.08 Ø 14

Palline Grandi / Large Balls



Martellato / Hammered

H.950 mm.

- Art. 05.230.09 □ 12
- Art. 05.230.10 □ 14
- Art. 05.230.11 □ 16
- Art. 05.230.12 □ 18

H.1000 mm.

- Art. 05.230.13 □ 12
- Art. 05.230.14 □ 14
- Art. 05.230.15 □ 16
- Art. 05.230.16 □ 18

H.1200 mm.

- Art. 05.230.17 □ 12
- Art. 05.230.18 □ 14
- Art. 05.230.19 □ 16
- Art. 05.230.20 □ 18

H.1500 mm.

- Art. 05.230.21 □ 12
- Art. 05.230.22 □ 14
- Art. 05.230.23 □ 16
- Art. 05.230.24 □ 18

H.950 mm.

- Art. 05.230.25 □ 12
- Art. 05.230.26 □ 14
- Art. 05.230.27 □ 16
- Art. 05.230.28 □ 18

H.1000 mm.

- Art. 05.230.29 □ 12
- Art. 05.230.30 □ 14
- Art. 05.230.31 □ 16
- Art. 05.230.32 □ 18

H.1200 mm.

- Art. 05.230.33 □ 12
- Art. 05.230.34 □ 14
- Art. 05.230.35 □ 16
- Art. 05.230.36 □ 18

H.1500 mm.

- Art. 05.230.37 □ 12
- Art. 05.230.38 □ 14
- Art. 05.230.39 □ 16
- Art. 05.230.40 □ 18

Tondo / Round

H.950 mm.

- Art. 05.230.41 Ø12
- Art. 05.230.42 Ø14
- Art. 05.230.43 Ø16
- Art. 05.230.44 Ø18

H.1000 mm.

- Art. 05.230.45 Ø12
- Art. 05.230.46 Ø14
- Art. 05.230.47 Ø16
- Art. 05.230.48 Ø18

H.1200 mm.

- Art. 05.230.49 Ø12
- Art. 05.230.50 Ø14
- Art. 05.230.51 Ø16
- Art. 05.230.52 Ø18

H.1500 mm.

- Art. 05.230.53 Ø12
- Art. 05.230.54 Ø14
- Art. 05.230.55 Ø16
- Art. 05.230.56 Ø18

H.950 mm.

- Art. 05.230.57 □ 12
- Art. 05.230.58 □ 14
- Art. 05.230.59 □ 16
- Art. 05.230.60 □ 18

H.1000 mm.

- Art. 05.230.61 □ 12
- Art. 05.230.62 □ 14
- Art. 05.230.63 □ 16
- Art. 05.230.64 □ 18

H.1200 mm.

- Art. 05.230.65 □ 12
- Art. 05.230.66 □ 14
- Art. 05.230.67 □ 16
- Art. 05.230.68 □ 18

H.1500 mm.

- Art. 05.230.69 □ 12
- Art. 05.230.70 □ 14
- Art. 05.230.71 □ 16
- Art. 05.230.72 □ 18





Fascetta inserita a caldo / Hot-inserted clip



Martellato / Hammered

H.950 mm.	
Art. 05.230.73	<input type="checkbox"/> 14
Art. 05.230.74	<input type="checkbox"/> 16
H.1000 mm.	
Art. 05.230.75	<input type="checkbox"/> 14
Art. 05.230.76	<input type="checkbox"/> 16
H.1200 mm.	
Art. 05.230.77	<input type="checkbox"/> 14
Art. 05.230.78	<input type="checkbox"/> 16
H.1500 mm.	
Art. 05.230.79	<input type="checkbox"/> 14
Art. 05.230.80	<input type="checkbox"/> 16
H.2000 mm.	
Art. 05.230.81	<input type="checkbox"/> 14
Art. 05.230.82	<input type="checkbox"/> 16

H.950 mm.	
Art. 05.230.83	<input type="checkbox"/> 14
Art. 05.230.84	<input type="checkbox"/> 16
H.1000 mm.	
Art. 05.230.85	<input type="checkbox"/> 14
Art. 05.230.86	<input type="checkbox"/> 16
H.1200 mm.	
Art. 05.230.87	<input type="checkbox"/> 14
Art. 05.230.88	<input type="checkbox"/> 16
H.1500 mm.	
Art. 05.230.89	<input type="checkbox"/> 14
Art. 05.230.90	<input type="checkbox"/> 16
H.2000 mm.	
Art. 05.230.91	<input type="checkbox"/> 14
Art. 05.230.92	<input type="checkbox"/> 16

Tondo / Round

H.950 mm.	
Art. 05.230.93	<input type="checkbox"/> Ø14
Art. 05.230.94	<input type="checkbox"/> Ø16
H.1000 mm.	
Art. 05.230.95	<input type="checkbox"/> Ø14
Art. 05.230.96	<input type="checkbox"/> Ø16
H.1200 mm.	
Art. 05.230.97	<input type="checkbox"/> Ø14
Art. 05.230.98	<input type="checkbox"/> Ø16
H.1500 mm.	
Art. 05.230.99	<input type="checkbox"/> Ø14
Art. 05.230.100	<input type="checkbox"/> Ø16
H.2000 mm.	
Art. 05.230.101	<input type="checkbox"/> Ø14
Art. 05.230.102	<input type="checkbox"/> Ø16

Martellato / Hammered

H.950 mm.	
Art. 05.230.103	<input type="checkbox"/> 14
Art. 05.230.104	<input type="checkbox"/> 16
H.1000 mm.	
Art. 05.230.105	<input type="checkbox"/> 14
Art. 05.230.106	<input type="checkbox"/> 16
H.1200 mm.	
Art. 05.230.107	<input type="checkbox"/> 14
Art. 05.230.108	<input type="checkbox"/> 16
H.1500 mm.	
Art. 05.230.109	<input type="checkbox"/> 14
Art. 05.230.110	<input type="checkbox"/> 16
H.2000 mm.	
Art. 05.230.111	<input type="checkbox"/> 14
Art. 05.230.112	<input type="checkbox"/> 16

H.950 mm.	
Art. 05.230.113	<input type="checkbox"/> 14
Art. 05.230.114	<input type="checkbox"/> 16
H.1000 mm.	
Art. 05.230.115	<input type="checkbox"/> 14
Art. 05.230.116	<input type="checkbox"/> 16
H.1200 mm.	
Art. 05.230.117	<input type="checkbox"/> 14
Art. 05.230.118	<input type="checkbox"/> 16
H.1500 mm.	
Art. 05.230.119	<input type="checkbox"/> 14
Art. 05.230.120	<input type="checkbox"/> 16
H.2000 mm.	
Art. 05.230.121	<input type="checkbox"/> 14
Art. 05.230.122	<input type="checkbox"/> 16

Tondo / Round

H.950 mm.	
Art. 05.230.123	<input type="checkbox"/> Ø14
Art. 05.230.124	<input type="checkbox"/> Ø16
H.1000 mm.	
Art. 05.230.125	<input type="checkbox"/> Ø14
Art. 05.230.126	<input type="checkbox"/> Ø16
H.1200 mm.	
Art. 05.230.127	<input type="checkbox"/> Ø14
Art. 05.230.128	<input type="checkbox"/> Ø16
H.1500 mm.	
Art. 05.230.129	<input type="checkbox"/> Ø14
Art. 05.230.130	<input type="checkbox"/> Ø16
H.2000 mm.	
Art. 05.230.131	<input type="checkbox"/> Ø14
Art. 05.230.132	<input type="checkbox"/> Ø16



Martellato / Hammered

H.1000 mm.	
Art. 05.230.133	<input type="checkbox"/> 14
Art. 05.230.134	<input type="checkbox"/> 16
Art. 05.230.135	<input type="checkbox"/> 18
H.1200 mm.	
Art. 05.230.136	<input type="checkbox"/> 14
Art. 05.230.137	<input type="checkbox"/> 16
Art. 05.230.138	<input type="checkbox"/> 18
H.1500 mm.	
Art. 05.230.139	<input type="checkbox"/> 14
Art. 05.230.140	<input type="checkbox"/> 16
Art. 05.230.141	<input type="checkbox"/> 18

H.1000 mm.	
Art. 05.230.142	<input type="checkbox"/> 14
Art. 05.230.143	<input type="checkbox"/> 16
Art. 05.230.144	<input type="checkbox"/> 18
H.1200 mm.	
Art. 05.230.145	<input type="checkbox"/> 14
Art. 05.230.146	<input type="checkbox"/> 16
Art. 05.230.147	<input type="checkbox"/> 18
H.1500 mm.	
Art. 05.230.148	<input type="checkbox"/> 14
Art. 05.230.149	<input type="checkbox"/> 16
Art. 05.230.150	<input type="checkbox"/> 18

Tondo / Round

H.1000 mm.	
Art. 05.230.151	<input type="checkbox"/> Ø14
Art. 05.230.152	<input type="checkbox"/> Ø16
Art. 05.230.153	<input type="checkbox"/> Ø18
H.1200 mm.	
Art. 05.230.154	<input type="checkbox"/> Ø14
Art. 05.230.155	<input type="checkbox"/> Ø16
Art. 05.230.156	<input type="checkbox"/> Ø18
H.1500 mm.	
Art. 05.230.157	<input type="checkbox"/> Ø14
Art. 05.230.158	<input type="checkbox"/> Ø16
Art. 05.230.159	<input type="checkbox"/> Ø18

Tondo Lavorato
Worked Round Bar

H.1000 mm.	
Art. 05.230.160	<input type="checkbox"/> Ø14
Art. 05.230.161	<input type="checkbox"/> Ø16
Art. 05.230.162	<input type="checkbox"/> Ø18
H.1200 mm.	
Art. 05.230.163	<input type="checkbox"/> Ø14
Art. 05.230.164	<input type="checkbox"/> Ø16
Art. 05.230.165	<input type="checkbox"/> Ø18
H.1500 mm.	
Art. 05.230.166	<input type="checkbox"/> Ø14
Art. 05.230.167	<input type="checkbox"/> Ø16
Art. 05.230.168	<input type="checkbox"/> Ø18

Liscio / Smooth
H.950 x L.120 mm
Art. 05.230.169 12

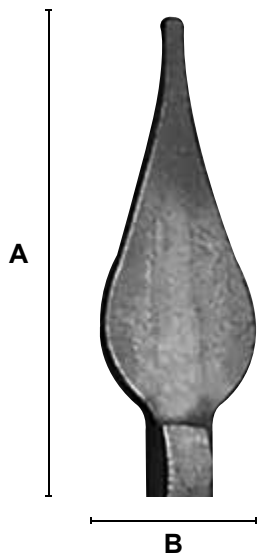
FIAMMA CLASSICA
Classic flame

Sezione tonda Round section	Sezione quadra Square section
Ø 12 mm	■ 12 mm
A = 100 mm B = 39 mm	A = 105 mm B = 40 mm
Ø 14 mm	■ 14 mm
A = 100 mm B = 40 mm	A = 105 mm B = 43 mm
Ø 16 mm	■ 16 mm
A = 111 mm B = 45 mm	A = 110 mm B = 47 mm

 Tolleranza 1 - 2 mm
 Tolerance 1 - 2 mm

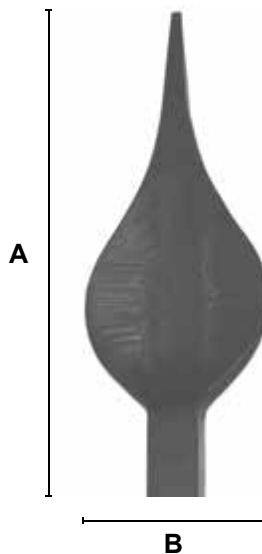
FIAMMA GRANDE
Large flame

Sezione tonda Round section	Sezione quadra Square section
Ø 12 mm	■ 12 mm
A = 112 mm B = 44 mm	A = 120 mm B = 48 mm
Ø 14 mm	■ 14 mm
A = 113 mm B = 50 mm	A = 130 mm B = 50 mm
Ø 16 mm	■ 16 mm
A = 113 mm B = 53 mm	A = 135 mm B = 53 mm

 Tolleranza 1 - 2 mm
 Tolerance 1 - 2 mm

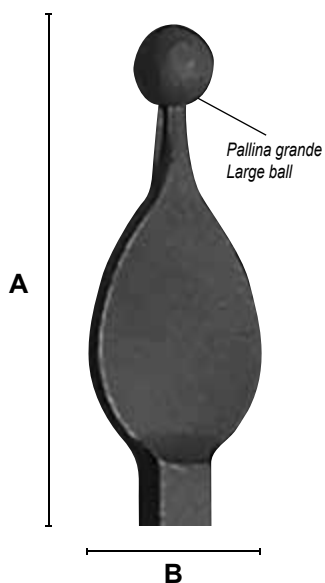
FIAMMA + PALLINA
Flame + ball

Sezione tonda Round section	Sezione quadra Square section
Ø 12 mm	■ 12 mm
A = 90 mm B = 35 mm	A = 100 mm B = 40 mm
Ø 14 mm	■ 14 mm
A = 100 mm B = 40 mm	A = 110 mm B = 42 mm
Ø 16 mm	■ 16 mm
A = 105 mm B = 44 mm	A = 120 mm B = 50 mm

 Tolleranza 1 - 2 mm
 Tolerance 1 - 2 mm

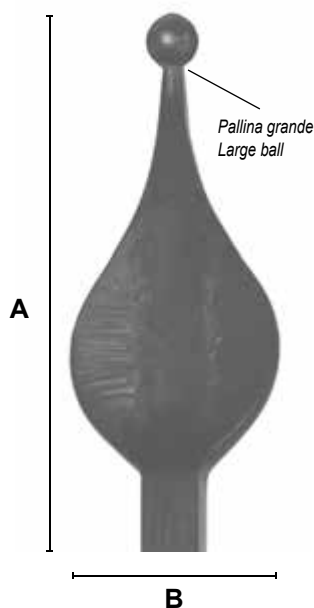
FIAMMA GRANDE + PALLINA
Large flame + ball

Sezione tonda Round section	Sezione quadra Square section
Ø 12 mm	■ 12 mm
A = 130 mm B = 44 mm	A = 135 mm B = 47 mm
Ø 14 mm	■ 14 mm
A = 140 mm B = 48 mm	A = 140 mm B = 50 mm
Ø 16 mm	■ 16 mm
A = 145 mm B = 50 mm	A = 145 mm B = 53 mm

 Tolleranza 1 - 2 mm
 Tolerance 1 - 2 mm



Fiamma classica / Classic flame

Fiamma + pallina / Flame + ball

H.950 mm.	
Art. 05.231	Ø12
Art. 05.232	Ø14
Art. 05.233	Ø16
Art. 05.234	Ø18
Art. 05.235	Ø20
H.1000 mm.	
Art. 05.236	Ø12
Art. 05.237	Ø14
Art. 05.238	Ø16
Art. 05.239	Ø18
Art. 05.240	Ø20
H.1200 mm.	
Art. 05.241	Ø12
Art. 05.242	Ø14
Art. 05.243	Ø16
Art. 05.244	Ø18
Art. 05.245	Ø20
H.1500 mm.	
Art. 05.246	Ø12
Art. 05.247	Ø14
Art. 05.248	Ø16
Art. 05.249	Ø18
Art. 05.250	Ø20

H.950 mm.	
Art. 05.231.01	Ø12
Art. 05.232.01	Ø14
Art. 05.233.01	Ø16
H.1000 mm.	
Art. 05.236.01	Ø12
Art. 05.237.01	Ø14
Art. 05.238.01	Ø16
H.1200 mm.	
Art. 05.241.01	Ø12
Art. 05.242.01	Ø14
Art. 05.243.01	Ø16
Art. 05.245.01	Ø20
H.1500 mm.	
Art. 05.246.01	Ø12
Art. 05.247.01	Ø14
Art. 05.248.01	Ø16
H.950 mm.	
Art. 09.442.01	□ 12
Art. 09.443.01	□ 14
Art. 09.444.01	□ 16
H.1000 mm.	
Art. 09.445.01	□ 12
Art. 09.446.01	□ 14
Art. 09.447.01	□ 16
H.1200 mm.	
Art. 09.448.01	□ 12
Art. 09.449.01	□ 14
Art. 09.450.01	□ 16
H.1500 mm.	
Art. 09.451.01	□ 12
Art. 09.452.01	□ 14
Art. 09.453.01	□ 16

Fiamma grande / Large flame

Fiamma classica / Classic flame

Fiamma grande / Large flame

Fiamma grande + pallina / Large flame + ball

Fiamma classica / Classic flame

Fiamma grande / Large flame

Tondo / Round	
H.950 mm	
Art. 05.231.02	Ø 12
Art. 05.232.02	Ø 14
Art. 05.233.02	Ø 16
H.1000 mm	
Art. 05.236.02	Ø 12
Art. 05.237.02	Ø 14
Art. 05.238.02	Ø 16
H.1200 mm	
Art. 05.241.02	Ø 12
Art. 05.242.02	Ø 14
Art. 05.243.02	Ø 16
H.1500 mm	
Art. 05.246.02	Ø 12
Art. 05.247.02	Ø 14
Art. 05.248.02	Ø 16

H.950 mm.	
Art. 05.251	□ 12
Art. 05.252	□ 14
Art. 05.253	□ 16
Art. 05.254	□ 18
Art. 05.255	□ 20
H.1000 mm.	
Art. 05.256	□ 12
Art. 05.257	□ 14
Art. 05.258	□ 16
Art. 05.259	□ 18
Art. 05.260	□ 20
H.1200 mm.	
Art. 05.261	□ 12
Art. 05.262	□ 14
Art. 05.263	□ 16
Art. 05.264	□ 18
Art. 05.265	□ 20
H.1500 mm.	
Art. 05.266	□ 12
Art. 05.267	□ 14
Art. 05.268	□ 16
Art. 05.269	□ 18
Art. 05.270	□ 20

Liscio / Smooth	
H.950 mm	
Art. 05.251.02	□ 12
Art. 05.252.02	□ 14
Art. 05.253.02	□ 16
H.1000 mm	
Art. 05.256.02	□ 12
Art. 05.257.02	□ 14
Art. 05.258.02	□ 16
H.1200 mm	
Art. 05.261.02	□ 12
Art. 05.262.02	□ 14
Art. 05.263.02	□ 16
H.1500 mm	
Art. 05.266.02	□ 12
Art. 05.267.02	□ 14
Art. 05.268.02	□ 16

Liscio / Smooth	
H.950 mm	
Art. 05.268.50	□ 12
Art. 05.268.51	□ 14
Art. 05.268.52	□ 16
Art. 05.268.53	Ø 12
Art. 05.268.54	Ø 14
Art. 05.268.55	Ø 16
H.1000 mm	
Art. 05.268.56	□ 12
Art. 05.268.57	□ 14
Art. 05.268.58	□ 16
Art. 05.268.59	Ø 12
Art. 05.268.60	Ø 14
Art. 05.268.61	Ø 16
H.1200 mm	
Art. 05.268.62	□ 12
Art. 05.268.63	□ 14
Art. 05.268.64	□ 16
Art. 05.268.65	Ø 12
Art. 05.268.66	Ø 14
Art. 05.268.67	Ø 16
H.1500 mm	
Art. 05.268.68	□ 12
Art. 05.268.69	□ 14
Art. 05.268.70	□ 16
Art. 05.268.71	Ø 12
Art. 05.268.72	Ø 14
Art. 05.268.73	Ø 16

Martellato / Hammered	
H.950 mm.	
Art. 05.271	□ 12
Art. 05.272	□ 14
Art. 05.273	□ 16
Art. 05.274	□ 18
Art. 05.275	□ 20
H.1000 mm.	
Art. 05.276	□ 12
Art. 05.277	□ 14
Art. 05.278	□ 16
Art. 05.279	□ 18
Art. 05.280	□ 20
H.1200 mm.	
Art. 05.281	□ 12
Art. 05.282	□ 14
Art. 05.283	□ 16
Art. 05.284	□ 18
Art. 05.285	□ 20
H.1500 mm.	
Art. 05.286	□ 12
Art. 05.287	□ 14
Art. 05.288	□ 16
Art. 05.289	□ 18
Art. 05.290	□ 20

Martellato / Hammered	
H.950 mm	
Art. 05.271.02	□ 12
Art. 05.272.02	□ 14
Art. 05.273.02	□ 16
H.1000 mm	
Art. 05.276.02	□ 12
Art. 05.277.02	□ 14
Art. 05.278.02	□ 16
H.1200 mm	
Art. 05.281.02	□ 12
Art. 05.282.02	□ 14
Art. 05.283.02	□ 16
H.1500 mm	
Art. 05.286.02	□ 12
Art. 05.287.02	□ 14
Art. 05.288.02	□ 16



Schiacciata sullo spigolo /
Ornament on the edge

Liscio / Smooth

H.950 mm

Art. 05.289.01 12
Art. 05.289.02 14
Art. 05.289.03 16

H.1000 mm

Art. 05.289.04 12
Art. 05.289.05 14
Art. 05.289.06 16

H.1200 mm

Art. 05.289.07 12
Art. 05.289.08 14
Art. 05.289.09 16

H.1500 mm

Art. 05.289.10 12
Art. 05.289.11 14
Art. 05.289.12 16



Martellato / Hammered

H.950 mm

Art. 05.290.01 12
Art. 05.290.02 14
Art. 05.290.03 16

H.1000 mm

Art. 05.290.04 12
Art. 05.290.05 14
Art. 05.290.06 16

H.1200 mm

Art. 05.290.07 12
Art. 05.290.08 14
Art. 05.290.09 16

H.1500 mm

Art. 05.290.10 12
Art. 05.290.11 14
Art. 05.290.12 16



Liscio / Smooth

H.950 mm

Art. 05.290.13 12
Art. 05.290.14 14
Art. 05.290.15 16

H.1000 mm

Art. 05.290.16 12
Art. 05.290.17 14
Art. 05.290.18 16

H.1200 mm

Art. 05.290.19 12
Art. 05.290.20 14
Art. 05.290.21 16

H.1500 mm

Art. 05.290.22 12
Art. 05.290.23 14
Art. 05.290.24 16



H.950 mm.

Art. 05.291 12
Art. 05.292 14
Art. 05.293 16

H.1000 mm.

Art. 05.294 12
Art. 05.295 14
Art. 05.296 16

H.1200 mm.

Art. 05.297 12
Art. 05.298 14
Art. 05.299 16

H.1500 mm.

Art. 05.300 12
Art. 05.301 14
Art. 05.302 16



H.950 mm.

Art. 05.303 12
Art. 05.304 14
Art. 05.305 16
Art. 05.306 18
Art. 05.307 20

H.1000 mm.

Art. 05.308 12
Art. 05.309 14
Art. 05.310 16
Art. 05.311 18
Art. 05.312 20

H.1200 mm.

Art. 05.313 12
Art. 05.314 14
Art. 05.315 16
Art. 05.316 18
Art. 05.317 20

H.1500 mm.

Art. 05.318 12
Art. 05.319 14
Art. 05.320 16
Art. 05.321 18
Art. 05.322 20



H.950 mm.

Art. 05.323 12
Art. 05.324 14
Art. 05.325 16
Art. 05.326 18
Art. 05.327 20

H.1000 mm.

Art. 05.328 12
Art. 05.329 14
Art. 05.330 16
Art. 05.331 18
Art. 05.332 20

H.1200 mm.

Art. 05.333 12
Art. 05.334 14
Art. 05.335 16
Art. 05.336 18
Art. 05.337 20

H.1500 mm.

Art. 05.338 12
Art. 05.339 14
Art. 05.340 16
Art. 05.341 18
Art. 05.342 20



Liscio / Smooth

H.950 mm

Art. 05.342.20 12
Art. 05.342.21 14

H.1000 mm

Art. 05.342.22 12
Art. 05.342.23 14

H.1200 mm

Art. 05.342.24 12
Art. 05.342.25 14

H.1500 mm

Art. 05.342.26 12
Art. 05.342.27 14



Liscio

≠ 25 x 8 mm

Art. 05.342.100 H.950
Art. 05.342.101 H.1000
Art. 05.342.102 H.1200
Art. 05.342.103 H.1500

Liscio

≠ 30 x 8 mm

Art. 05.342.104 H.950
Art. 05.342.105 H.1000
Art. 05.342.106 H.1200
Art. 05.342.107 H.1500



Martellato / Hammered

H.950 mm.

Art. 05.343 12
Art. 05.344 14

H.1000 mm.

Art. 05.345 12
Art. 05.346 14

H.1200 mm.

Art. 05.347 12
Art. 05.348 14

H.1500 mm.

Art. 05.349 12
Art. 05.350 14

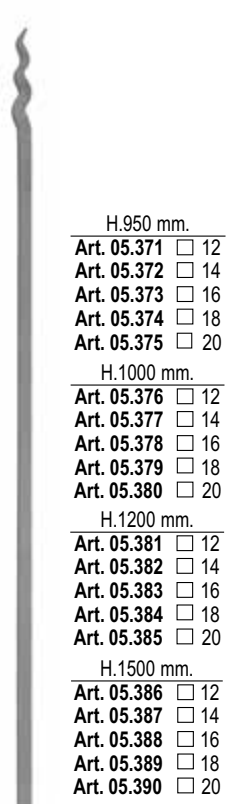
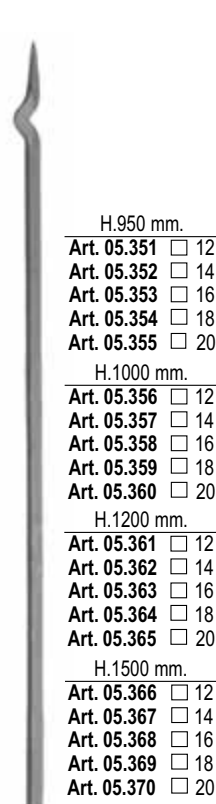

DIMENSIONI PALLINE PICCOLE E PALLINE GRANDI

Small balls and Large balls size

PALLINE PICCOLE /
SMALL BALLS



PALLINE GRANDI /
LARGE BALLS



sezione ferro iron section	pallina piccola small ball	pallina grande large ball
-------------------------------	-------------------------------	------------------------------

Sezione tonda / Round section		
Ø 12 mm	Ø 12 mm	Ø 14 mm
Ø 14 mm	Ø 14 mm	Ø 16 mm
Ø 16 mm	Ø 16 mm	Ø 18 mm
Ø 18 mm	Ø 18 mm	Ø 20 mm
Ø 20 mm	Ø 20 mm	Ø 24 mm

Sezione quadra / Square section		
■ 12x12 mm	Ø 12 mm	Ø 16 mm
■ 14x14 mm	Ø 14 mm	Ø 18 mm
■ 16x16 mm	Ø 16 mm	Ø 20 mm
■ 18x18 mm	Ø 18 mm	Ø 20 mm
■ 20x20 mm	Ø 20 mm	Ø 24 mm

PALLINE GRANDI / LARGE BALLS



Martellato / Hammered

H.950 mm.

Art. 05.390.01 □ 12
Art. 05.390.02 □ 14

H.1000 mm.

Art. 05.390.03 □ 12
Art. 05.390.04 □ 14

H.1200 mm.

Art. 05.390.05 □ 12
Art. 05.390.06 □ 14

H.1500 mm.

Art. 05.390.07 □ 12
Art. 05.390.08 □ 14

Martellato / Hammered

H.950 mm.

Art. 05.390.09 □ 12
Art. 05.390.10 □ 14

H.1000 mm.

Art. 05.390.11 □ 12
Art. 05.390.12 □ 14

H.1200 mm.

Art. 05.390.13 □ 12
Art. 05.390.14 □ 14

H.1500 mm.

Art. 05.390.15 □ 12
Art. 05.390.16 □ 14

H.950 mm.

Art. 05.399 □ 12
Art. 05.400 □ 14

H.1000 mm.

Art. 05.401 □ 12
Art. 05.402 □ 14

H.1200 mm.

Art. 05.403 □ 12
Art. 05.404 □ 14

H.1500 mm.

Art. 05.405 □ 12
Art. 05.406 □ 14

H.950 mm.

Art. 05.407 □ 12
Art. 05.408 □ 14

H.1000 mm.

Art. 05.409 □ 12
Art. 05.410 □ 14

H.1200 mm.

Art. 05.411 □ 12
Art. 05.412 □ 14

H.1500 mm.

Art. 05.413 □ 12
Art. 05.414 □ 14

Tondo / Round

H.950 mm.

Art. 05.414.01 Ø12
Art. 05.414.02 Ø14
Art. 05.414.03 Ø16

H.1000 mm.

Art. 05.414.04 Ø12
Art. 05.414.05 Ø14
Art. 05.414.06 Ø16

H.1200 mm.

Art. 05.414.07 Ø12
Art. 05.414.08 Ø14
Art. 05.414.09 Ø16

H.1500 mm.

Art. 05.414.10 Ø12
Art. 05.414.11 Ø14
Art. 05.414.12 Ø16

Tondo / Round

H.950 mm.

Art. 05.414.13 Ø12
Art. 05.414.14 Ø14
Art. 05.414.15 Ø16

H.1000 mm.

Art. 05.414.16 Ø12
Art. 05.414.17 Ø14
Art. 05.414.18 Ø16

H.1200 mm.

Art. 05.414.19 Ø12
Art. 05.414.20 Ø14
Art. 05.414.21 Ø16

H.1500 mm.

Art. 05.414.22 Ø12
Art. 05.414.23 Ø14
Art. 05.414.24 Ø16

H.950 mm.

Art. 05.415 □ 12
Art. 05.416 □ 14

H.1000 mm.

Art. 05.417 □ 12
Art. 05.418 □ 14

H.1200 mm.

Art. 05.419 □ 12
Art. 05.420 □ 14

H.1500 mm.

Art. 05.421 □ 12
Art. 05.422 □ 14

PALLINE PICCOLE / SMALL BALLS

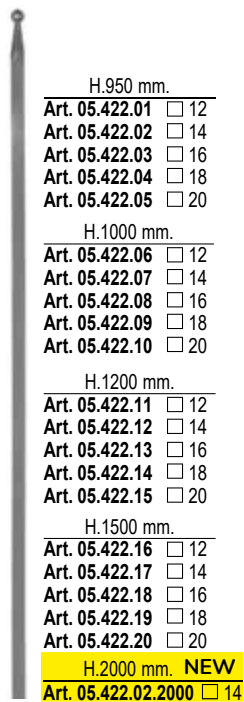

- H.950 mm.
Art. 05.422.01 12
Art. 05.422.02 14
Art. 05.422.03 16
Art. 05.422.04 18
Art. 05.422.05 20
- H.1000 mm.
Art. 05.422.06 12
Art. 05.422.07 14
Art. 05.422.08 16
Art. 05.422.09 18
Art. 05.422.10 20
- H.1200 mm.
Art. 05.422.11 12
Art. 05.422.12 14
Art. 05.422.13 16
Art. 05.422.14 18
Art. 05.422.15 20
- H.1500 mm.
Art. 05.422.16 12
Art. 05.422.17 14
Art. 05.422.18 16
Art. 05.422.19 18
Art. 05.422.20 20
- H.2000 mm. **NEW**
Art. 05.422.02.2000 14

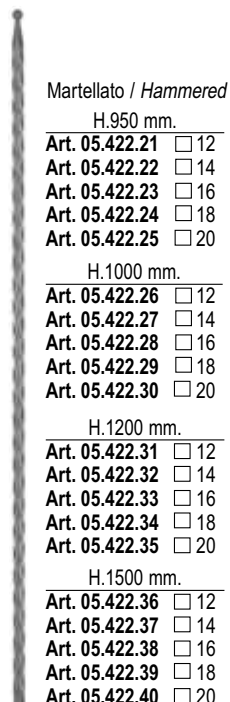

- Martellato / *Hammered*
H.950 mm.
Art. 05.422.21 12
Art. 05.422.22 14
Art. 05.422.23 16
Art. 05.422.24 18
Art. 05.422.25 20
- H.1000 mm.
Art. 05.422.26 12
Art. 05.422.27 14
Art. 05.422.28 16
Art. 05.422.29 18
Art. 05.422.30 20
- H.1200 mm.
Art. 05.422.31 12
Art. 05.422.32 14
Art. 05.422.33 16
Art. 05.422.34 18
Art. 05.422.35 20
- H.1500 mm.
Art. 05.422.36 12
Art. 05.422.37 14
Art. 05.422.38 16
Art. 05.422.39 18
Art. 05.422.40 20

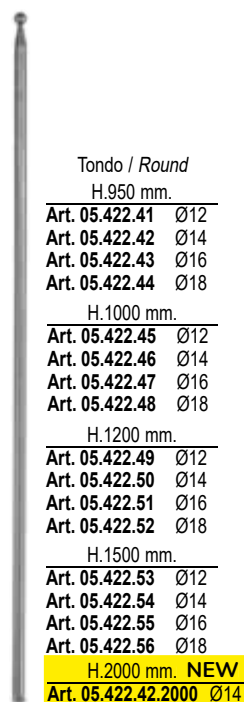

- Tondo / *Round*
H.950 mm.
Art. 05.422.41 Ø12
Art. 05.422.42 Ø14
Art. 05.422.43 Ø16
Art. 05.422.44 Ø18
- H.1000 mm.
Art. 05.422.45 Ø12
Art. 05.422.46 Ø14
Art. 05.422.47 Ø16
Art. 05.422.48 Ø18
- H.1200 mm.
Art. 05.422.49 Ø12
Art. 05.422.50 Ø14
Art. 05.422.51 Ø16
Art. 05.422.52 Ø18
- H.1500 mm.
Art. 05.422.53 Ø12
Art. 05.422.54 Ø14
Art. 05.422.55 Ø16
Art. 05.422.56 Ø18
- H.2000 mm. **NEW**
Art. 05.422.42.2000 Ø14

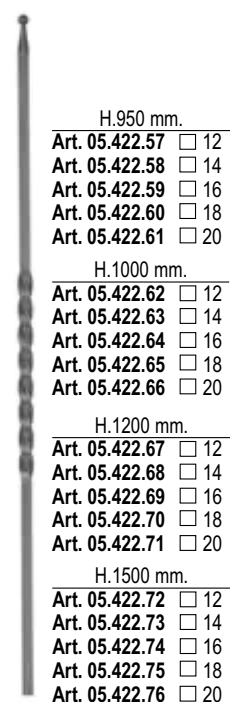

- H.950 mm.
Art. 05.422.57 12
Art. 05.422.58 14
Art. 05.422.59 16
Art. 05.422.60 18
Art. 05.422.61 20
- H.1000 mm.
Art. 05.422.62 12
Art. 05.422.63 14
Art. 05.422.64 16
Art. 05.422.65 18
Art. 05.422.66 20
- H.1200 mm.
Art. 05.422.67 12
Art. 05.422.68 14
Art. 05.422.69 16
Art. 05.422.70 18
Art. 05.422.71 20
- H.1500 mm.
Art. 05.422.72 12
Art. 05.422.73 14
Art. 05.422.74 16
Art. 05.422.75 18
Art. 05.422.76 20

PALLINE PICCOLE / SMALL BALLS



- H.950 mm.
Art. 05.422.77 12
Art. 05.422.78 14
Art. 05.422.79 16

- Martellato / *Hammered*
H.950 mm.
Art. 05.422.80 12
Art. 05.422.81 14
Art. 05.422.82 16

- Tondo / *Round*
H.950 mm.
Art. 05.422.83 Ø14
Art. 05.422.84 Ø16

- H.950 mm.
Art. 05.422.85 12
Art. 05.422.86 14
Art. 05.422.87 16

- Martellato / *Hammered*
H.950 mm.
Art. 05.422.88 12
Art. 05.422.89 14
Art. 05.422.90 16

- Tondo / *Round*
H.950 mm.
Art. 05.422.91 Ø14
Art. 05.422.92 Ø16

- H.950 mm.
Art. 05.422.93 12
Art. 05.422.94 14
Art. 05.422.95 16

PALLINE PICCOLE / SMALL BALLS

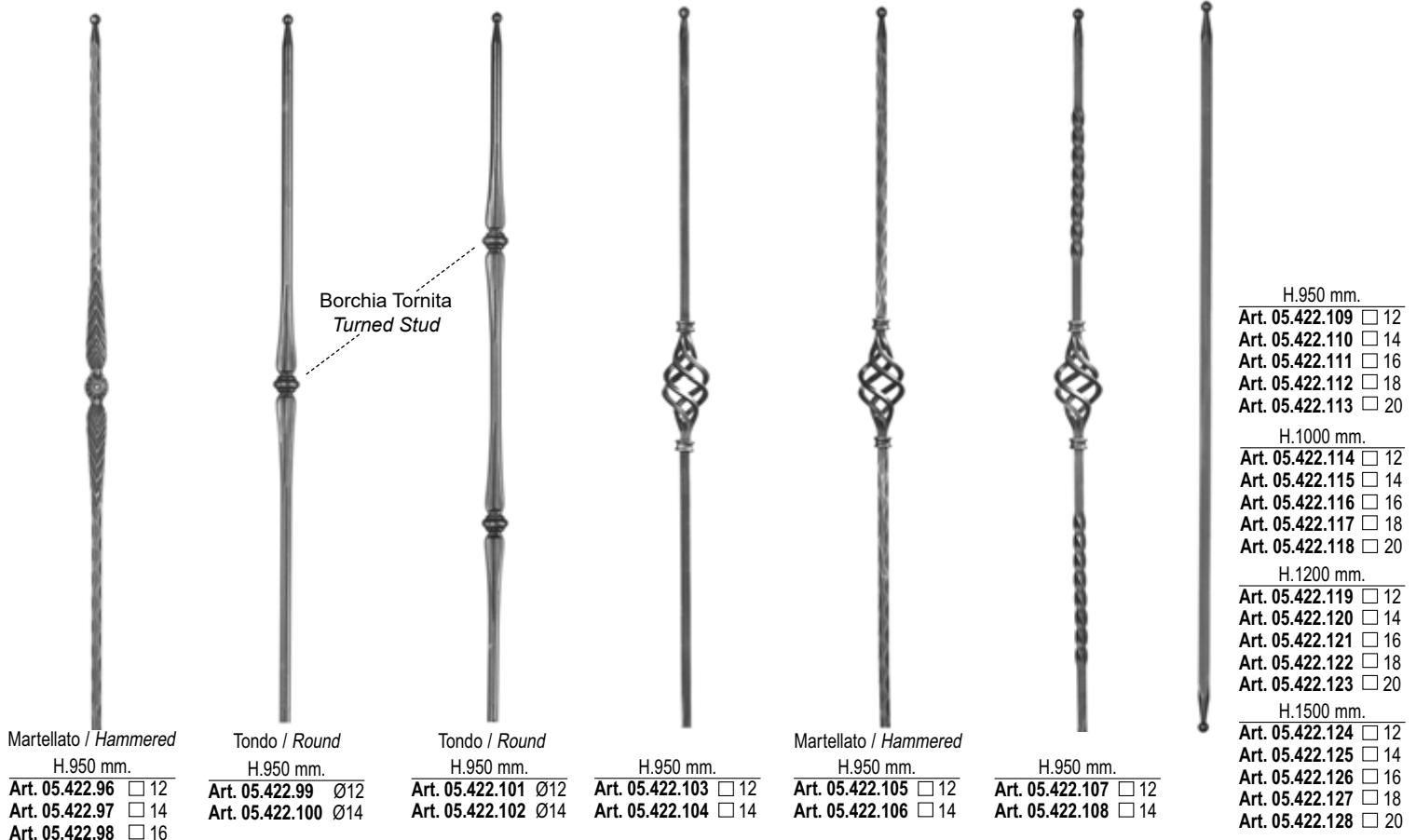

Martellato / Hammered
H.950 mm.
Art. 05.422.96 12
Art. 05.422.97 14
Art. 05.422.98 16

Tondo / Round
H.950 mm.
Art. 05.422.99 \varnothing 12
Art. 05.422.100 \varnothing 14

Tondo / Round
H.950 mm.
Art. 05.422.101 \varnothing 12
Art. 05.422.102 \varnothing 14

H.950 mm.
Art. 05.422.103 12
Art. 05.422.104 14

Martellato / Hammered
H.950 mm.
Art. 05.422.105 12
Art. 05.422.106 14

H.950 mm.
Art. 05.422.107 12
Art. 05.422.108 14

H.950 mm.
Art. 05.422.109 12
Art. 05.422.110 14
Art. 05.422.111 16
Art. 05.422.112 18
Art. 05.422.113 20

H.1000 mm.
Art. 05.422.114 12
Art. 05.422.115 14
Art. 05.422.116 16
Art. 05.422.117 18
Art. 05.422.118 20

H.1200 mm.
Art. 05.422.119 12
Art. 05.422.120 14
Art. 05.422.121 16
Art. 05.422.122 18
Art. 05.422.123 20

H.1500 mm.
Art. 05.422.124 12
Art. 05.422.125 14
Art. 05.422.126 16
Art. 05.422.127 18
Art. 05.422.128 20

PALLINE PICCOLE / SMALL BALLS

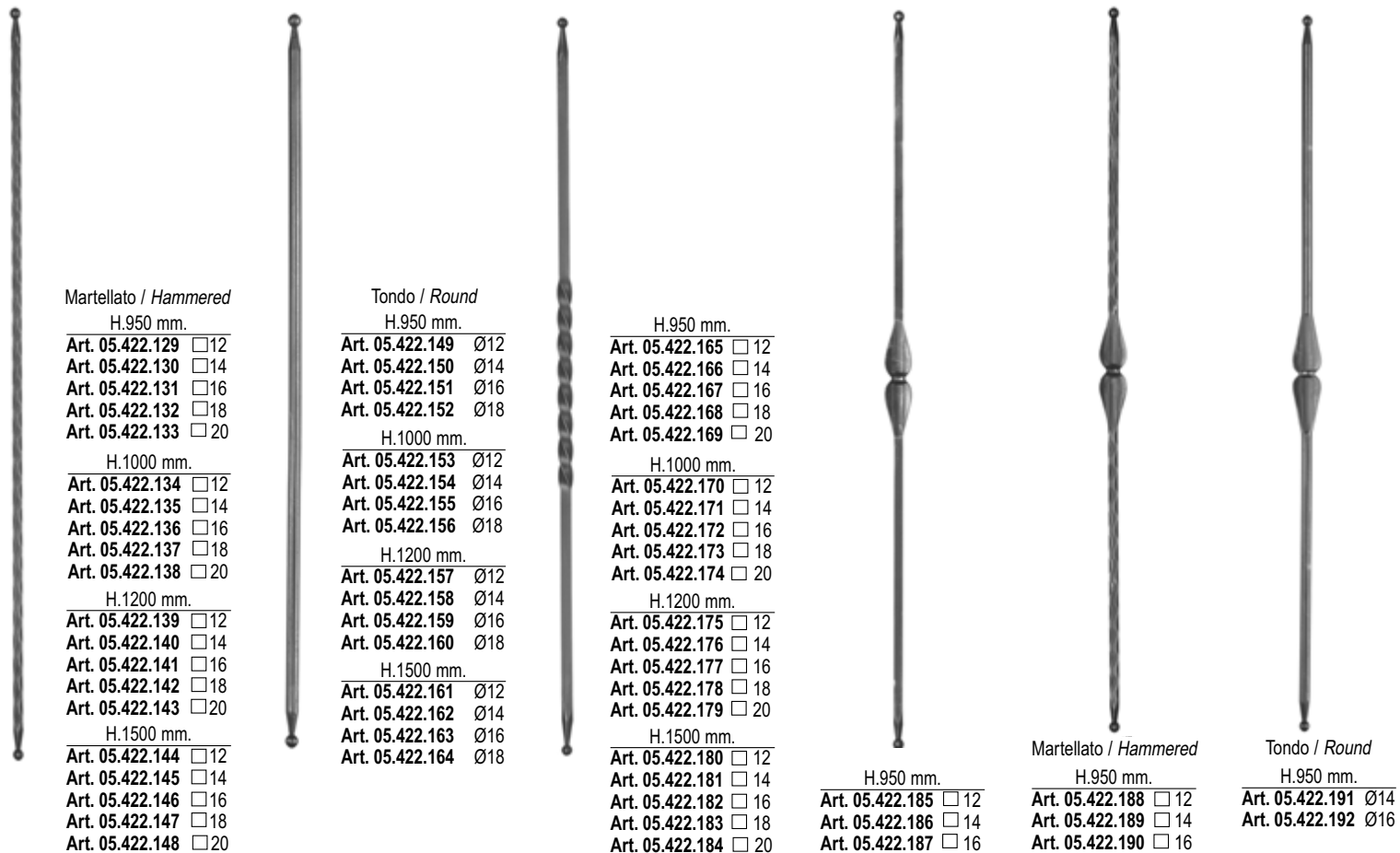

Martellato / Hammered
H.950 mm.
Art. 05.422.129 12
Art. 05.422.130 14
Art. 05.422.131 16
Art. 05.422.132 18
Art. 05.422.133 20

H.1000 mm.
Art. 05.422.134 12
Art. 05.422.135 14
Art. 05.422.136 16
Art. 05.422.137 18
Art. 05.422.138 20

H.1200 mm.
Art. 05.422.139 12
Art. 05.422.140 14
Art. 05.422.141 16
Art. 05.422.142 18
Art. 05.422.143 20

H.1500 mm.
Art. 05.422.144 12
Art. 05.422.145 14
Art. 05.422.146 16
Art. 05.422.147 18
Art. 05.422.148 20

Tondo / Round
H.950 mm.
Art. 05.422.149 \varnothing 12
Art. 05.422.150 \varnothing 14
Art. 05.422.151 \varnothing 16
Art. 05.422.152 \varnothing 18

H.1000 mm.
Art. 05.422.153 \varnothing 12
Art. 05.422.154 \varnothing 14
Art. 05.422.155 \varnothing 16
Art. 05.422.156 \varnothing 18

H.1200 mm.
Art. 05.422.157 \varnothing 12
Art. 05.422.158 \varnothing 14
Art. 05.422.159 \varnothing 16
Art. 05.422.160 \varnothing 18

H.1500 mm.
Art. 05.422.161 \varnothing 12
Art. 05.422.162 \varnothing 14
Art. 05.422.163 \varnothing 16
Art. 05.422.164 \varnothing 18

H.950 mm.
Art. 05.422.165 12
Art. 05.422.166 14
Art. 05.422.167 16
Art. 05.422.168 18
Art. 05.422.169 20

H.1000 mm.
Art. 05.422.170 12
Art. 05.422.171 14
Art. 05.422.172 16
Art. 05.422.173 18
Art. 05.422.174 20

H.1200 mm.
Art. 05.422.175 12
Art. 05.422.176 14
Art. 05.422.177 16
Art. 05.422.178 18
Art. 05.422.179 20

H.1500 mm.
Art. 05.422.180 12
Art. 05.422.181 14
Art. 05.422.182 16
Art. 05.422.183 18
Art. 05.422.184 20

H.950 mm.
Art. 05.422.185 12
Art. 05.422.186 14
Art. 05.422.187 16

Martellato / Hammered
H.950 mm.
Art. 05.422.188 12
Art. 05.422.189 14
Art. 05.422.190 16

Tondo / Round
H.950 mm.
Art. 05.422.191 \varnothing 14
Art. 05.422.192 \varnothing 16

PALLINE PICCOLE / SMALL BALLS

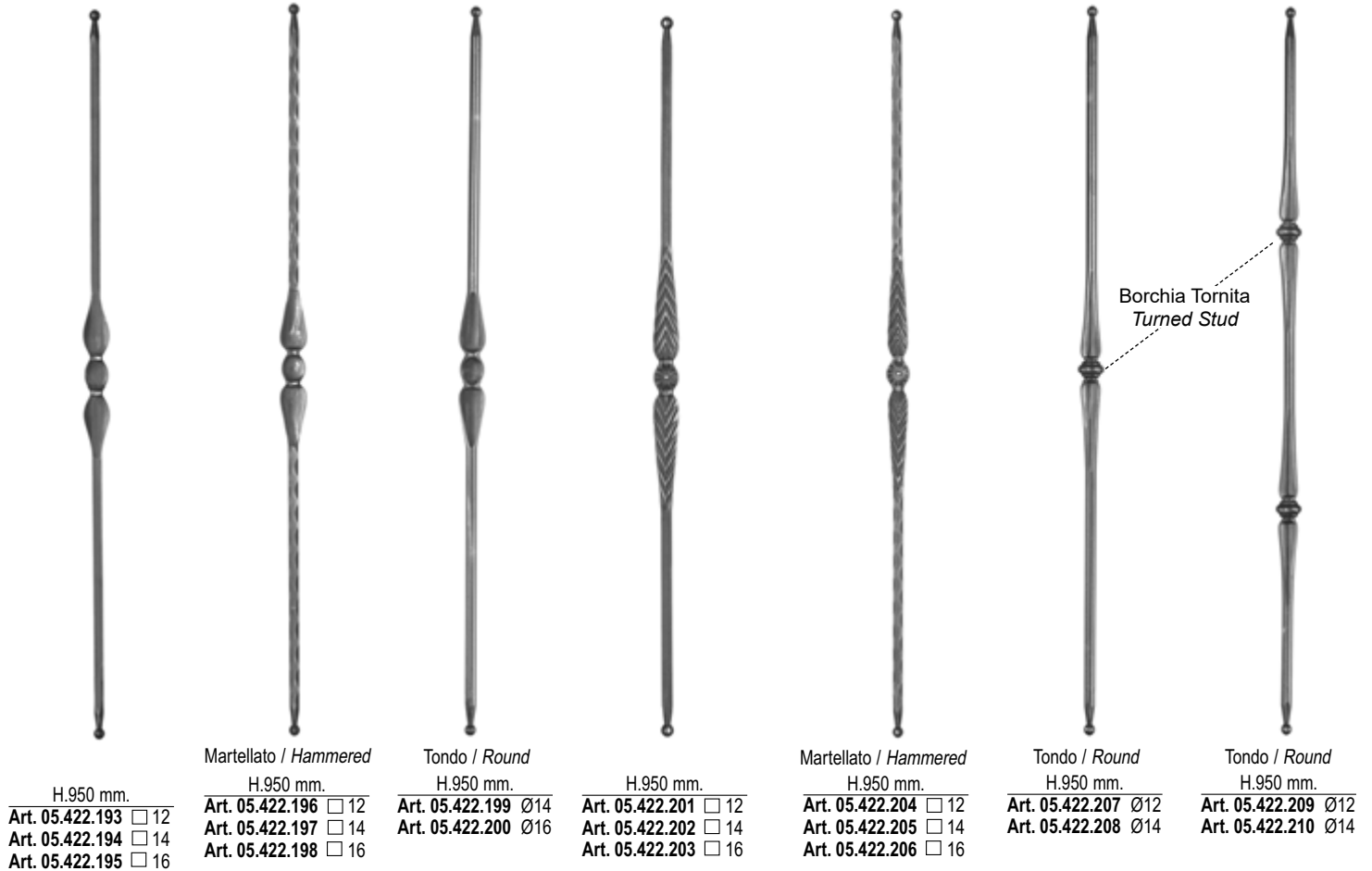

PALLINE PICCOLE / SMALL BALLS

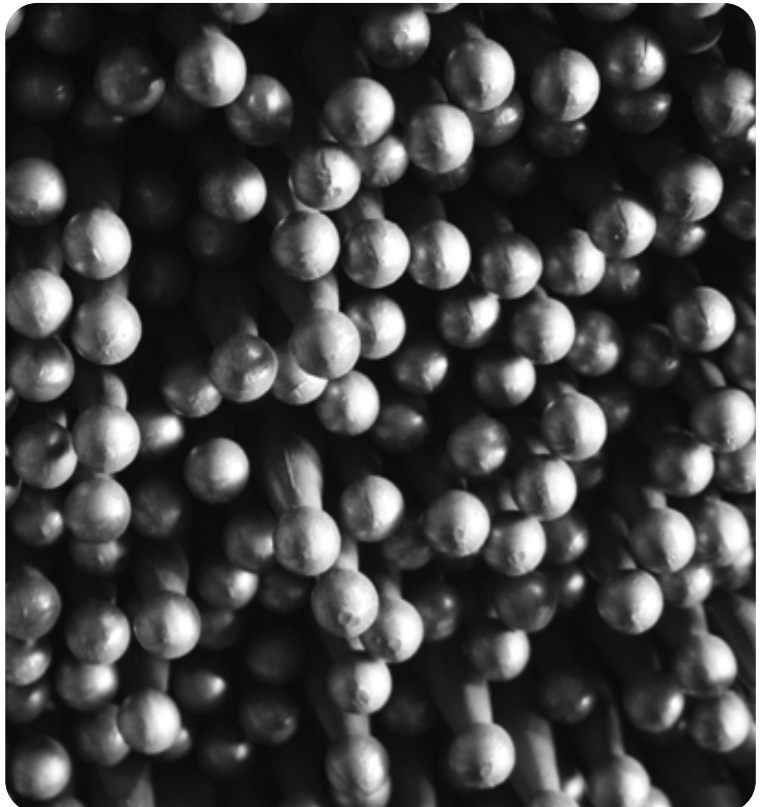

Tutte le parti di questo catalogo - foto comprese - sono di proprietà Euro-Fer. La riproduzione, anche parziale, è vietata in ogni forma e con ogni mezzo. / Every part of this catalogue - photos included - is Euro-Fer's property. All forms of copying are strictly prohibited.

PALLINE SU BARRE / BALLS ON BARS

SU RICHIESTA SIAMO IN GRADO DI PRODURRE I SEGUENTI PALETTI CON PALLINA ANCHE SU MISURA.
ON REQUEST WE ARE ABLE TO MANUFACTURE THE FOLLOWING BALL ON BAR INFILLS, CUSTOMIZED ALSO AVAILABLE.

- Pallina / Ball Ø 16 mm - H. 1000
Art. 05.427.100 tondo liscio Ø 12 mm con pallina Ø 16 mm / round plain 12 mm solid bar with 16 mm ball
- Pallina / Ball Ø 18 mm - H. 1000
Art. 05.427.110 tondo liscio Ø 12 mm con pallina Ø 18 mm / round plain 12 mm solid bar with 18 mm ball
Art. 05.427.112 tondo liscio Ø 14 mm con pallina Ø 18 mm / round plain 14 mm solid bar with 18 mm ball
- Art. 05.427.115** quadro liscio □ 12x12 mm con pallina Ø 18 mm / square plain □ 12x12 mm solid bar with 18 mm ball
- Pallina / Ball Ø 20 mm - H. 1000
Art. 05.427.130 tondo liscio Ø 12 mm con pallina Ø 20 mm / round plain 12 mm solid bar with 20 mm ball
Art. 05.427.132 tondo liscio Ø 14 mm con pallina Ø 20 mm / round plain 12 mm solid bar with 20 mm ball
Art. 05.427.134 tondo liscio Ø 16 mm con pallina Ø 20 mm / round plain 14 mm solid bar with 20 mm ball
- Art. 05.427.140** quadro liscio □ 12x12 mm con pallina Ø 20 mm / square plain □ 12x12 mm solid bar with 20 mm ball
Art. 05.427.142 quadro liscio □ 14x14 mm con pallina Ø 20 mm / square plain □ 14x14 mm solid bar with 20 mm ball
- Pallina / Ball Ø 24 mm - H. 1000
Art. 05.427.160 tondo liscio Ø 12 mm con pallina Ø 24 mm / round plain 12 mm solid bar with 24 mm ball
Art. 05.427.162 tondo liscio Ø 14 mm con pallina Ø 24 mm / round plain 12 mm solid bar with 24 mm ball
Art. 05.427.164 tondo liscio Ø 16 mm con pallina Ø 24 mm / round plain 14 mm solid bar with 24 mm ball
- Art. 05.427.170** quadro liscio □ 12x12 mm con pallina Ø 24 mm / square plain □ 12x12 mm solid bar with 24 mm ball
Art. 05.427.172 quadro liscio □ 14x14 mm con pallina Ø 24 mm / square plain □ 14x14 mm solid bar with 24 mm ball
Art. 05.427.174 quadro liscio □ 16x16 mm con pallina Ø 24 mm / square plain □ 16x16 mm solid bar with 24 mm ball



Paletti / Bars H. 1000

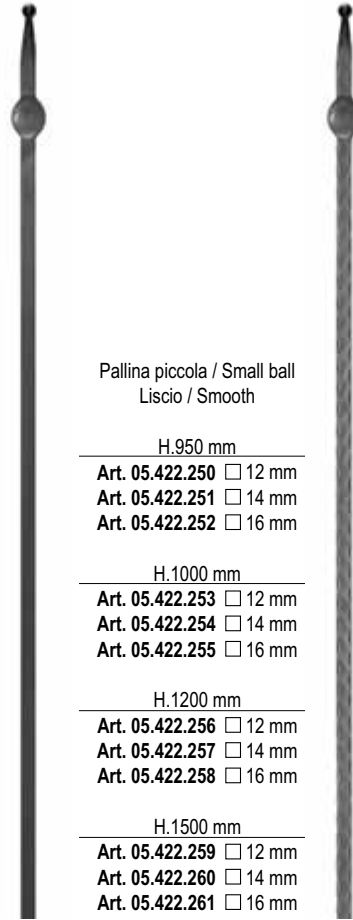

Pallina piccola / Small ball
Liscio / Smooth

H.950 mm

- Art. 05.422.250** □ 12 mm
Art. 05.422.251 □ 14 mm
Art. 05.422.252 □ 16 mm

H.1000 mm

- Art. 05.422.253** □ 12 mm
Art. 05.422.254 □ 14 mm
Art. 05.422.255 □ 16 mm

H.1200 mm

- Art. 05.422.256** □ 12 mm
Art. 05.422.260 □ 14 mm
Art. 05.422.258 □ 16 mm

H.1500 mm

- Art. 05.422.259** □ 12 mm
Art. 05.422.260 □ 14 mm
Art. 05.422.261 □ 16 mm

Pallina piccola / Small ball
Martellato / Hammered

H.950 mm

- Art. 05.422.300** □ 12 mm
Art. 05.422.301 □ 14 mm
Art. 05.422.302 □ 16 mm

H.1000 mm

- Art. 05.422.303** □ 12 mm
Art. 05.422.307 □ 14 mm
Art. 05.422.305 □ 16 mm

H.1200 mm

- Art. 05.422.306** □ 12 mm
Art. 05.422.310 □ 14 mm
Art. 05.422.308 □ 16 mm

H.1500 mm

- Art. 05.422.309** □ 12 mm
Art. 05.422.310 □ 14 mm
Art. 05.422.311 □ 16 mm

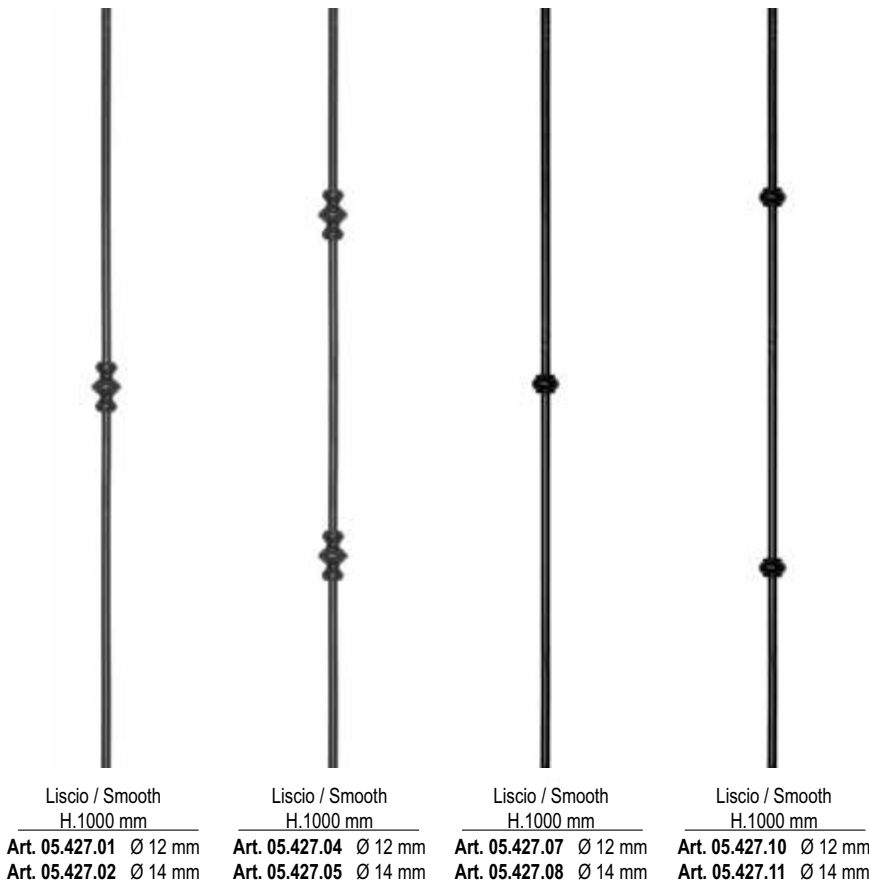

Liscio / Smooth
H.1000 mm

- Art. 05.427.01** Ø 12 mm
Art. 05.427.02 Ø 14 mm

Liscio / Smooth
H.1000 mm

- Art. 05.427.04** Ø 12 mm
Art. 05.427.05 Ø 14 mm

Liscio / Smooth
H.1000 mm

- Art. 05.427.07** Ø 12 mm
Art. 05.427.08 Ø 14 mm

Liscio / Smooth
H.1000 mm

- Art. 05.427.10** Ø 12 mm
Art. 05.427.11 Ø 14 mm

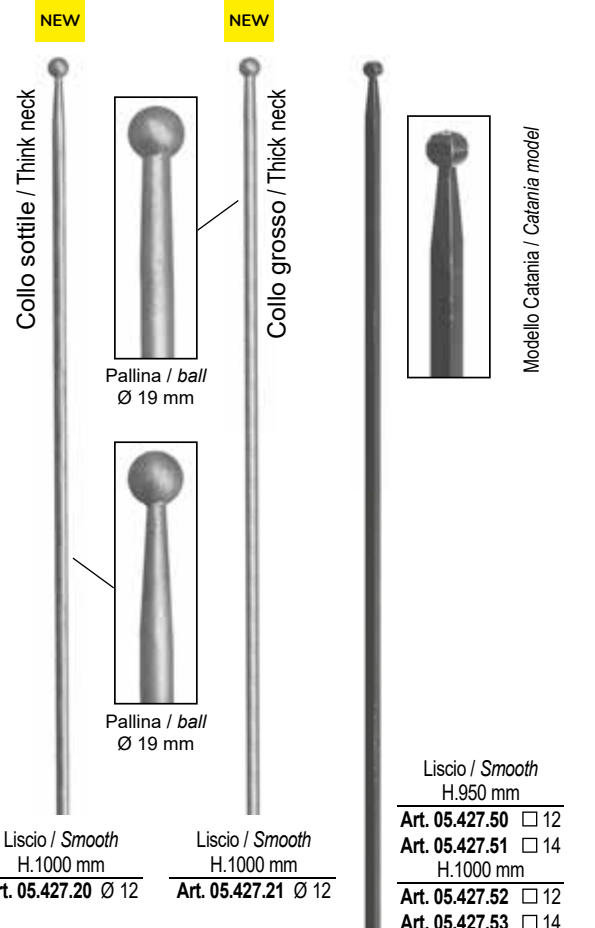

Collo sottile / Thin neck

Pallina / ball
Ø 19 mm

Pallina / ball
Ø 19 mm

Collo grosso / Thick neck

Liscio / Smooth
H.950 mm

- Art. 05.427.50** □ 12
Art. 05.427.51 □ 14
H.1000 mm
Art. 05.427.52 □ 12
Art. 05.427.53 □ 14

Modello Catania / Catania model

NEW

BORCHIE IN OTTONE / BRASS STUDS



H.950 X L.40 mm.
Art. 05.431.01 Ø 40



H.950 X L.35 mm.
Art. 05.431.02 Ø 36



H.950 X L.35 mm.
Art. 05.431.03 Ø 35



H.950 X L.42 mm.
Art. 05.431.04 Ø 40



H.950 X L. 40 mm.
Art. 05.431.05 Ø 40



Tubi ferro conificati / Cone - shaped iron tubes

H.730 mm.
Art. 05.428 Ø 22
Art. 05.429 Ø 30
H.830 mm.
Art. 05.430 Ø 22
Art. 05.431 Ø 30



H.950 mm.
Art. 05.432 □ 12



H.950 mm.
Art. 05.433 □ 12



Martell. / Hammered
H.950 mm.
Art. 05.434 □ 12



Martell. / Hammered
H.950 mm.
Art. 05.435 □ 12



H.950 mm.
Art. 05.436 Ø 15

Pigne a 9 Trafilati / 9 - Element Basket

NEW



Liscio / Smooth
H.1000 mm
Art. 05.436.10 □ 14
Art. 05.436.15 □ 12

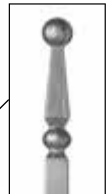

NEW



Liscio / Smooth
H.1000 mm
Art. 05.436.20 Ø 12

Tutte le parti di questo catalogo - foto comprese - sono di proprietà Euro-Fer. La riproduzione, anche parziale, è vietata in ogni forma e con ogni mezzo. / Every part of this catalogue - photos included - is Euro-Fer's property. All forms of copying are strictly prohibited.

PANNELLI LISCI E PALETTI PER RECINZIONI
PLAIN PANEL UNITS AND STAKES FOR FENCES



H.900 X L.330 mm.
Art. 05.437 Ø 14



H.900 X L.350 mm.
Art. 05.437.01 ≙ 12 X 6 mm.
Art. 05.437.02 ≙ 14 X 6 mm.

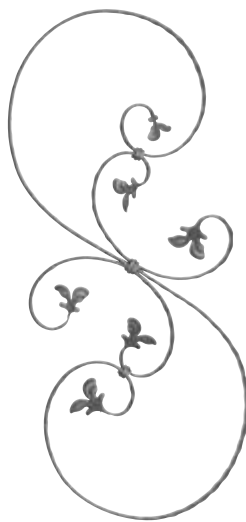

Martellato / *Hammered*
 H.860 X L.350 mm.
Art. 05.438 ≙ 12 X 6 mm.
Art. 05.438.01 ≙ 16 X 5 mm.



Martellato / *Hammered*
 H.860 X L.350 mm.
Art. 05.438.02 ≙ 12 X 6 mm.
Art. 05.438.03 ≙ 16 X 5 mm.



Liscio / *Smooth*
 H.900 X L.330 mm.
Art. 05.439 □ 14
 Martellato / *Hammered*
 H.900 X L.330 mm.
Art. 05.440 □ 14



Con fiori su ambo i lati
Flowers on both sides
 H.900 X L.350 mm.
Art. 05.440.01 □ 12



H.900 X L.350 mm.
Art. 05.440.02 Ø 10



Modello Scala / *Scala Model*
 H.860 x L.350 mm
Art. 05.440.03 ≙ 14 x 6 mm



Liscio / *Smooth*
 H.900 x L.370 mm
Art. 05.440.05 ≙ 12 x 6 mm



H.1100 mm.
Art. 05.441 □ 25
Art. 05.442 □ 30



Liscio / *Smooth*
 H.950 mm.
Art. 05.443 Ø 12



Liscio / *Smooth*
 H.950 mm.
Art. 05.444 Ø 12



Liscio / *Smooth*
 H.950 mm.
Art. 05.445 Ø 12

⊗ fiori da entrambi i lati / *flowers on both sides*

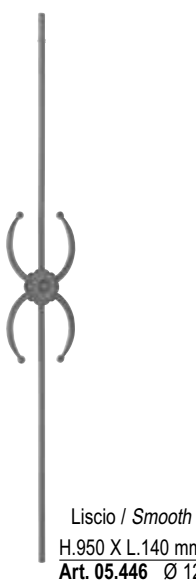

Liscio / *Smooth*
 H.950 X L.140 mm
Art. 05.446 Ø 12



Liscio / *Smooth*
 H.950 X L.100 mm.
Art. 05.447 Ø 12



Liscio / *Smooth*
 H.950 X L.100 mm.
Art. 05.448 Ø 12



Liscio / *Smooth*
 H.950 x L.180 mm
Art. 05.448.01 Ø 12 mm
 Con fiori su ambo i lati /
Flowers on both sides



Fiore in ottone / *Brass flower*



Liscio / *Smooth*
 H.950 x mm
Art. 05.448.02
 Ø 12 mm
Art. 05.448.03
 Ø 14 mm

Con fiori su ambo i lati / *Flowers on both sides*



Liscio / *Smooth*
 H.950 X L.120 mm.
Art. 05.449 Ø 12

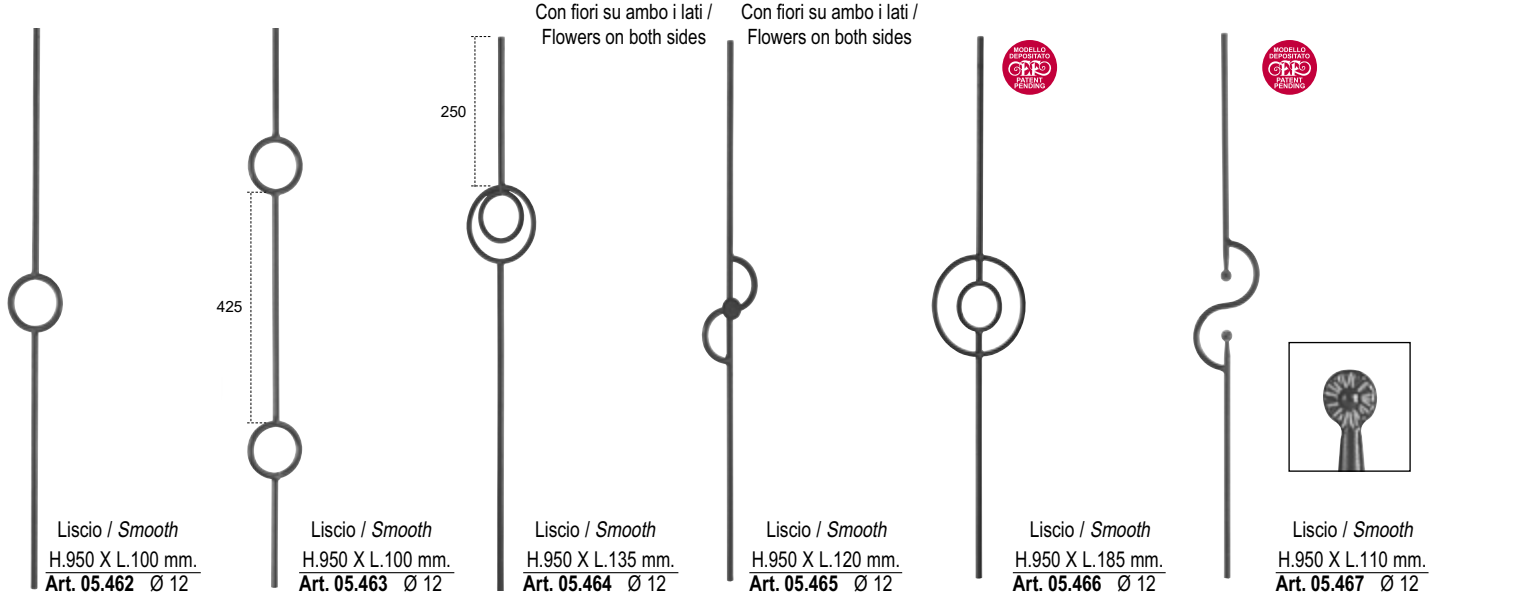
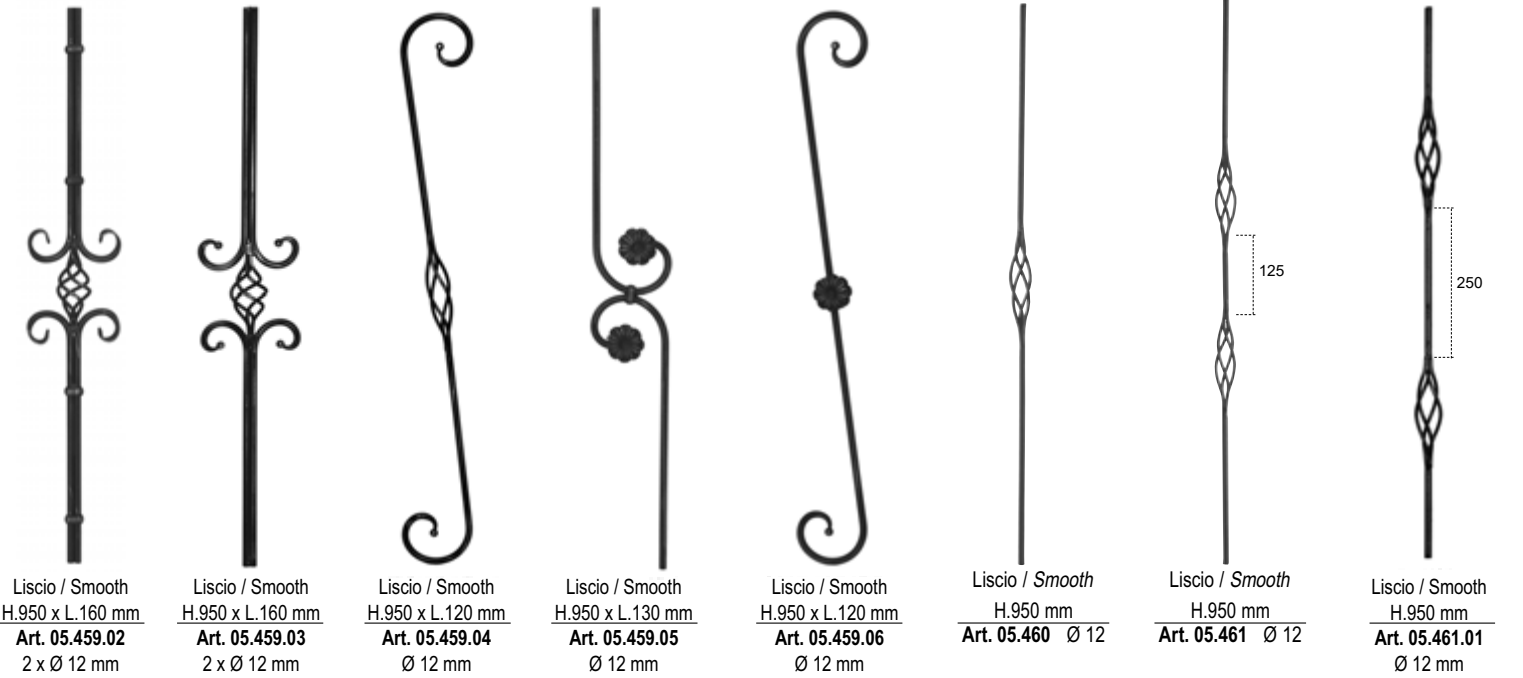
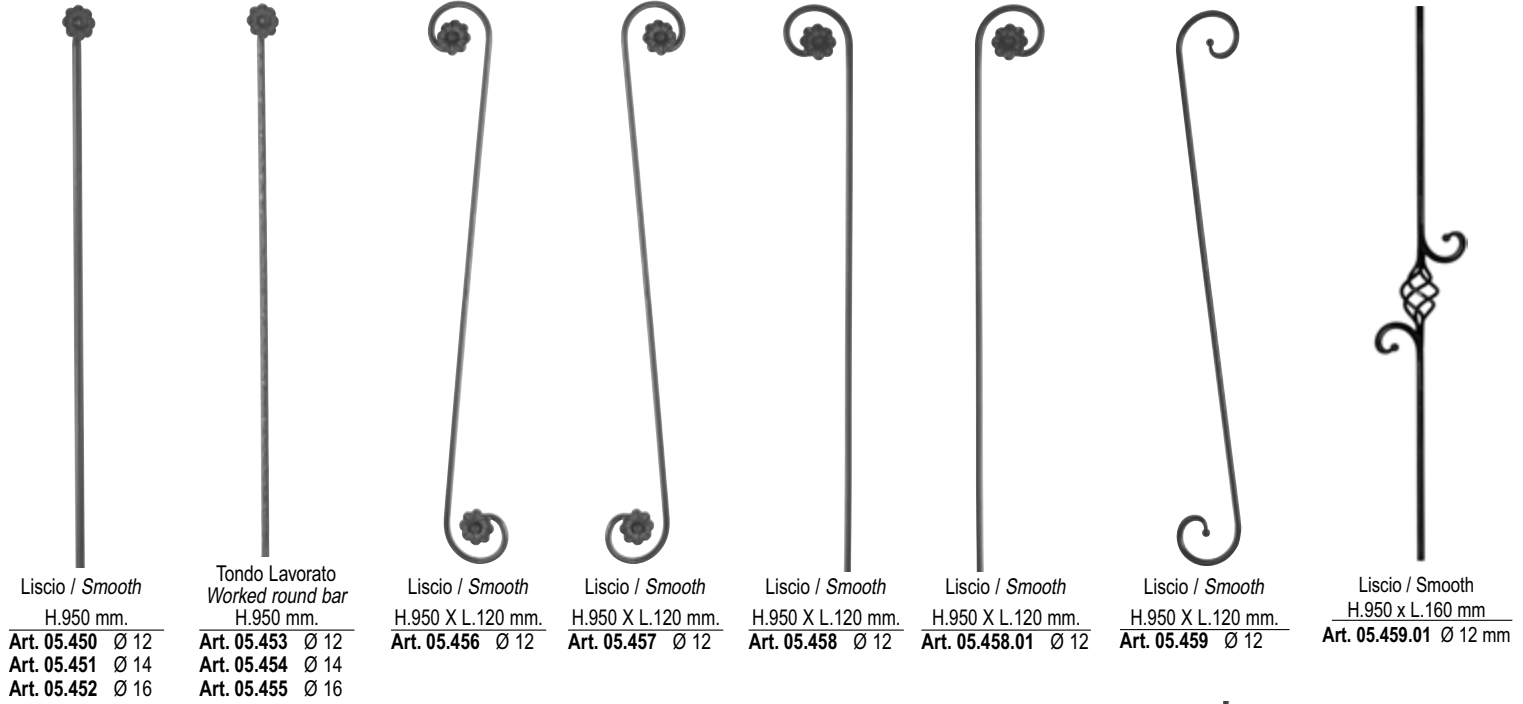

Tutte le parti di questo catalogo - foto comprese - sono di proprietà Euro-Fer. La riproduzione, anche parziale, è vietata in ogni forma e con ogni mezzo. / Every part of this catalogue - photos included - is Euro-Fer's property. All forms of copying are strictly prohibited.

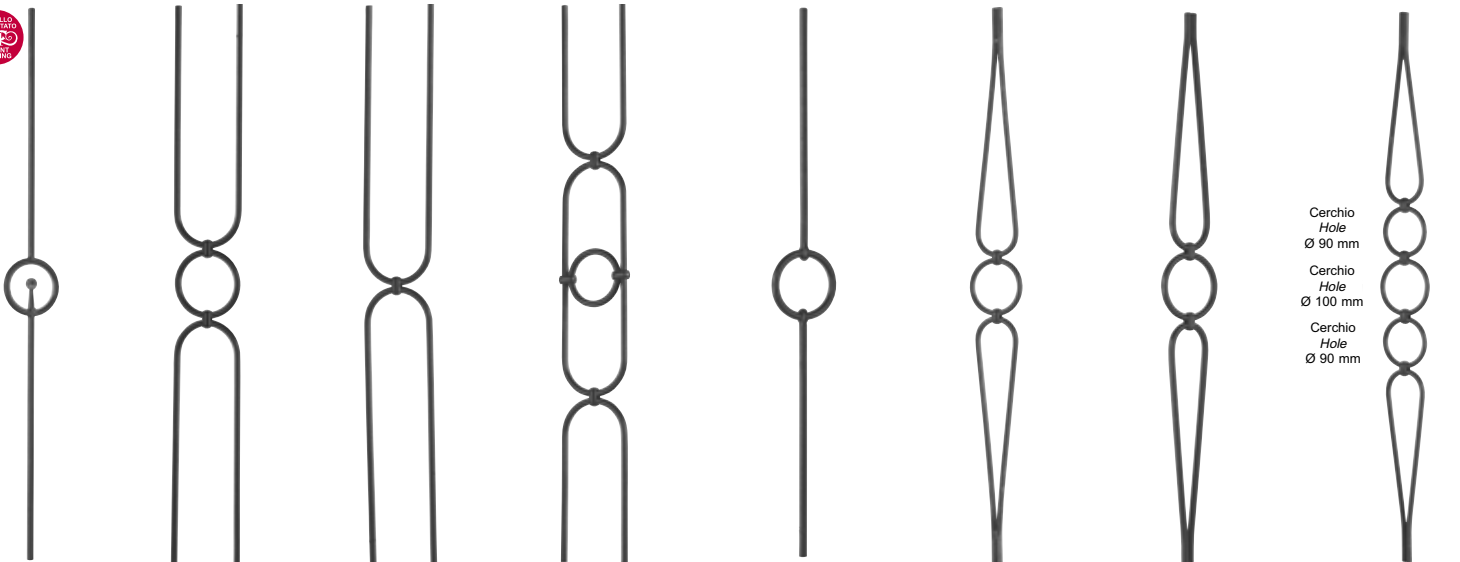

Cerchio Hole
 Ø 90 mm
 Cerchio Hole
 Ø 100 mm
 Cerchio Hole
 Ø 90 mm

Liscio / Smooth H.950 X L.100 mm. Art. 05.468 Ø 12	Liscio / Smooth H.950 X L.125 mm. Art. 05.469 Ø 12 Art. 05.469.01 Ø 14	Liscio / Smooth H.950 X L.125 mm. Art. 05.470 Ø 12 Art. 05.470.01 Ø 14	Liscio / Smooth H.950 X L.130 mm. Art. 05.471 Ø 12 Art. 05.471.01 Ø 14	Liscio / Smooth H.950 X L.125 mm. Art. 05.472 Ø 12 Art. 05.472.01 Ø 14	Liscio / Smooth H.950 X L.125 mm. Art. 05.473 Ø 12 Art. 05.473.01 Ø 10	Liscio / Smooth H.950 X L.100 mm. Art. 05.474 Ø 10	Liscio / Smooth H.950 X L.100 mm. Art. 05.475 Ø 10
--	---	---	---	---	---	--	--

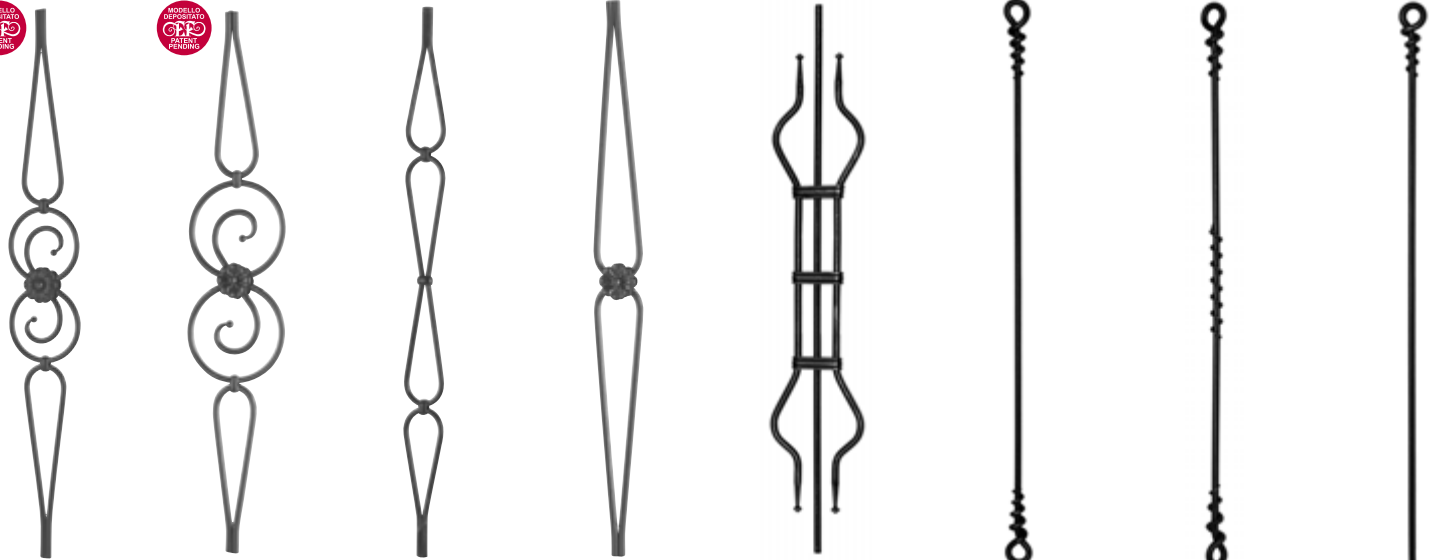

Liscio / Smooth H.950 X L.140 mm. Art. 05.476 Ø 10	Liscio / Smooth H.950 X L.180 mm. Art. 05.477 Ø 12	Liscio / Smooth H.950 X L.75 mm. Art. 05.478 Ø 10 Art. 05.478.01 Ø 12	Liscio / Smooth H.950 X L.85 mm. Art. 05.479 Ø 10 Art. 05.479.01 Ø 12	Liscio / Smooth H.950 x L.150 mm Art. 05.479.02 Ø 12 mm	Liscio / Smooth H.1000 x L.45 mm Art. 05.479.10 Ø 12 mm	Liscio / Smooth H.1000 x L.45 mm Art. 05.479.11 Ø 12 mm	Liscio / Smooth H.1000 x L.45 mm Art. 05.479.12 Ø 12 mm
--	--	--	--	---	---	---	---

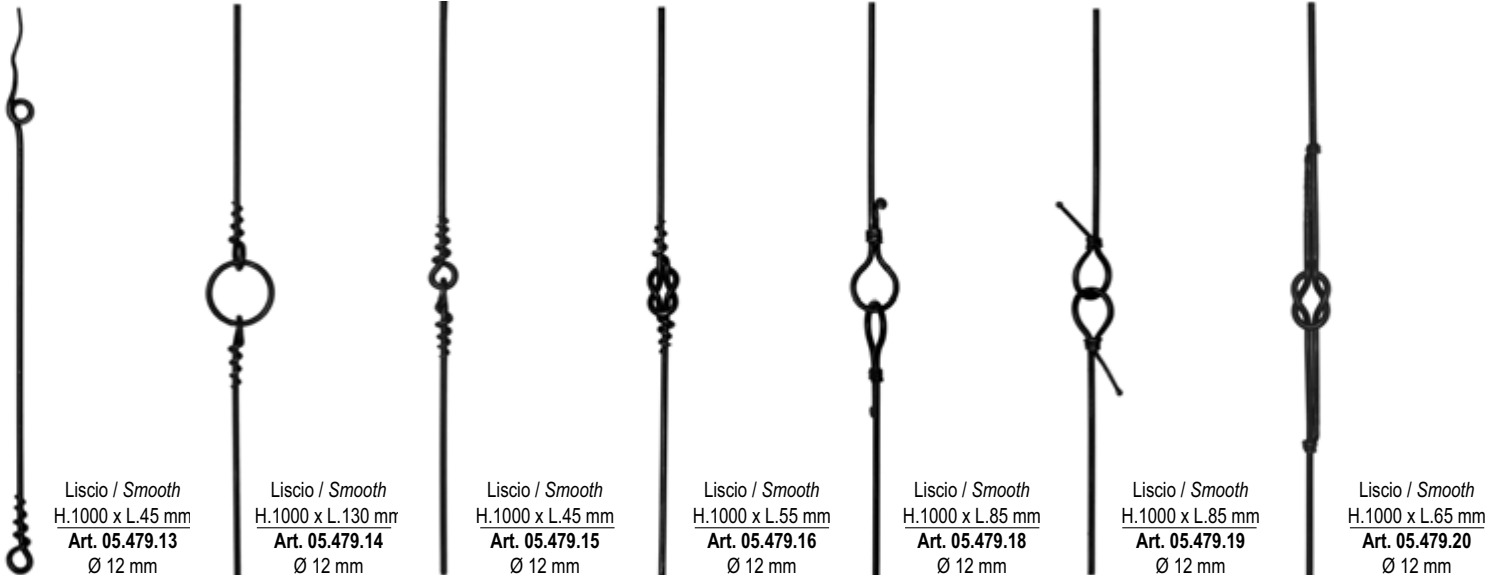

Liscio / Smooth H.1000 x L.45 mm Art. 05.479.13 Ø 12 mm	Liscio / Smooth H.1000 x L.130 mm Art. 05.479.14 Ø 12 mm	Liscio / Smooth H.1000 x L.45 mm Art. 05.479.15 Ø 12 mm	Liscio / Smooth H.1000 x L.55 mm Art. 05.479.16 Ø 12 mm	Liscio / Smooth H.1000 x L.85 mm Art. 05.479.18 Ø 12 mm	Liscio / Smooth H.1000 x L.85 mm Art. 05.479.19 Ø 12 mm	Liscio / Smooth H.1000 x L.65 mm Art. 05.479.20 Ø 12 mm
---	--	---	---	---	---	---

Tutte le parti di questo catalogo - foto comprese - sono di proprietà Euro-Fer. La riproduzione, anche parziale, è vietata in ogni forma e con ogni mezzo. / Every part of this catalogue - photos included - is Euro-Fer's property. All forms of copying are strictly prohibited.



Liscio / Smooth
H.1000 x L.120 mm

Art. 05.479.29
□ 12 mm
Art. 05.479.30
□ 16 mm



Liscio / Smooth
H.1000 x L.120 mm
Art. 05.479.31
□ 16 mm



Liscio / Smooth
H.1000 x L.120 mm
Art. 05.479.32
□ 16 mm



Liscio / Smooth
H.1000 x L.120 mm
Art. 05.479.33
□ 16 mm



Liscio / Smooth
H.1000 x L.120 mm
Art. 05.479.34
□ 16 mm



Liscio / Smooth
H.1000 x L.120 mm
Art. 05.479.35
□ 16 mm



NEW

Liscio / Smooth
H.1000 x L.120 mm
Art. 05.479.50 □ 12 mm
Art. 05.479.51 □ 16 mm



NEW

Liscio / Smooth
H.1000 x L.120 mm
Art. 05.479.60
□ 12 mm
Art. 05.479.61
□ 16 mm



Liscio / Smooth
H.950 X L.175 mm.
Art. 05.480 Ø 14



Liscio / Smooth
H.950 X L.100 mm.
Art. 05.481 Ø 12



Liscio / Smooth
H.950 X L.100 mm.
Art. 05.482 Ø 12



Liscio / Smooth
H.950 X L.165 mm.
Art. 05.483 Ø 12



Liscio / Smooth
H.950 X L.165 mm.
Art. 05.484 Ø 12



Liscio / Smooth
H.950 X L.125 mm.
Art. 05.485 Ø 12



Liscio / Smooth
H.950 X L.130 mm.
Art. 05.486 Ø 12



Liscio / Smooth
H.950 X L.105 mm.
Art. 05.487 Ø 12

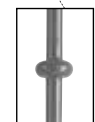
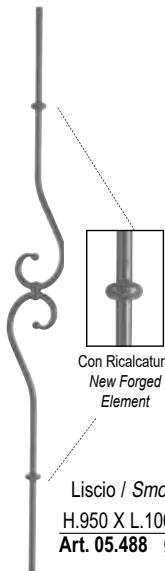

Con Ricalcatura
New Forged
Element

Liscio / Smooth
H.950 X L.100 mm.
Art. 05.488 Ø 12



Liscio / Smooth
H.950 X L.125 mm.
Art. 05.489 Ø 14



Liscio / Smooth
H.950 X L.110 mm.
Art. 05.490 Ø 14



Liscio / Smooth
H.950 X L.155 mm.
Art. 05.491 Ø 12

PANNELLI LISCI E PALETTI PER RECINZIONI
PLAIN PANEL UNITS AND STAKES FOR FENCES

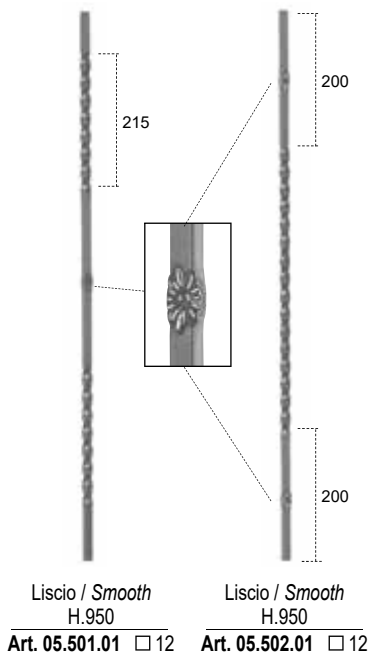
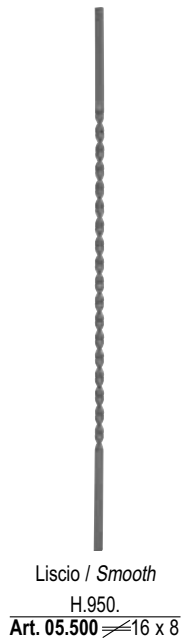
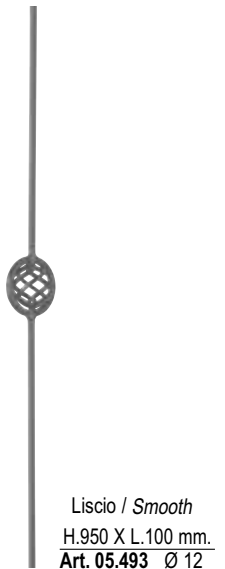
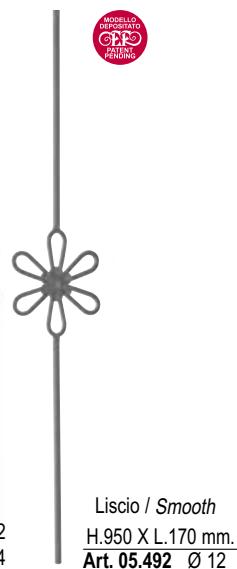
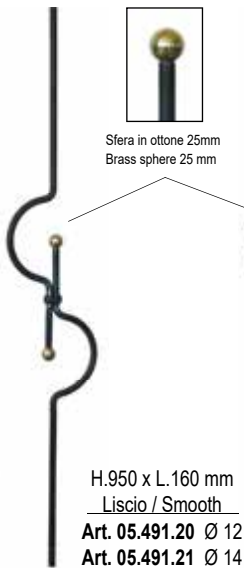
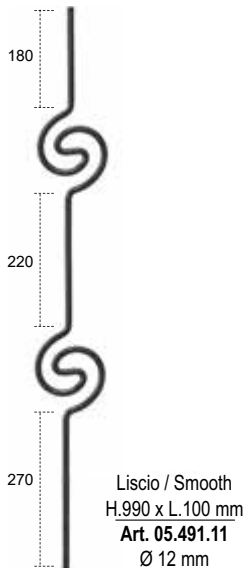
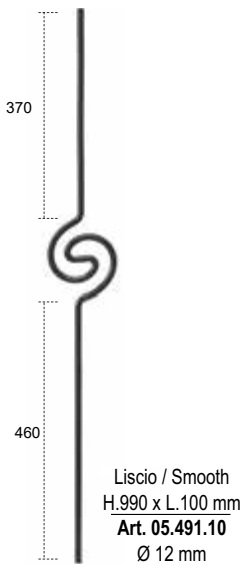



H.950 x L.115 mm
Martellato / *Hammered*
Art. 05.509.05 □ 12
Liscio / *Smooth*
Art. 05.509.06 □ 12



H.950 X L.90 mm.
Art. 05.510 □ 12



H.950 X L.145 mm.
Art. 05.511 □ 10



H.950 X L.140 mm.
Art. 05.512 □ 12



H.950 X L.140 mm.
Art. 05.513 □ 12



Liscio / *Smooth*
H.1000 x L.120 mm
Art. 05.513.100 □ 16
Art. 05.513.101 □ 20



Liscio / *Smooth*
H.1000 x L.120 mm
Art. 05.513.102 □ 16



Liscio / *Smooth*
H.1000 x L.120 mm
Art. 05.513.103 □ 16



Liscio / *Smooth*
H.1000 x L.135 mm
Art. 05.513.104 □ 16
Art. 05.513.105 □ 20



Liscio / *Smooth*
H.1000 x L.120 mm
Art. 05.513.106 □ 16



Liscio / *Smooth*
H.1000 x L.155 mm
Art. 05.513.107 □ 16



Liscio / *Smooth*
H.1000 x L.165 mm
Art. 05.513.108 □ 16



Liscio / *Smooth*
H.1000 x L.135 mm
Art. 05.513.109 □ 16



Liscio / *Smooth*
H.1000 x L.200 mm
Art. 05.513.110
□ 16 ≠ 16 x 8



Liscio / *Smooth*
H.1000 x L.190 mm
Art. 05.513.111
□ 16 ≠ 16 x 8



Liscio / *Smooth*
H.1000 x L.140 mm
Art. 05.513.112 □ 16



Liscio / *Smooth*
H.950 X L.200 mm.
Art. 05.515 □ 10



Liscio / *Smooth*
H.950 X L.165 mm.
Art. 05.516 □ 10



Liscio / *Smooth*
H.950 X L.200 mm.
Art. 05.517 □ 12

PANNELLI LISCI E PALETTI PER RECINZIONI
PLAIN PANEL UNITS AND STAKES FOR FENCES



Con Ricalcatura
New Forged
Element



Liscio / Smooth
H.950 X L.180 mm.
Art. 05.519 □ 12



Liscio / Smooth
H.950 X L.220 mm.
Art. 05.520 □ 12
≠ 12 x 6



Liscio / Smooth
H.950 X L.175 mm.
Art. 05.521 □ 10
≠ 12 x 6

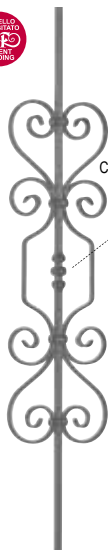

Liscio / Smooth
H.950 X L.180 mm.
Art. 05.522 □ 12



Liscio / Smooth
H.950 mm.
Art. 05.523 □ 12



Liscio / Smooth
H.950 mm.
Art. 05.523.01 □ 12



Martellato / Hammered
H.950 mm.
Art. 05.524 □ 12
Art. 05.524.01 □ 14



Martellato / Hammered
H.950 mm.
Art. 05.524.02 □ 12
Art. 05.524.03 □ 14



Liscio / Smooth
H.950 mm.
Art. 05.525 □ 12
Art. 05.525.01 □ 14



Liscio / Smooth
H.950 mm.
Art. 05.525.02 □ 12
Art. 05.525.03 □ 14



Liscio / Smooth
H.950 x L.60 mm
Art. 05.525.04
□ 12 mm



Liscio / Smooth
H.950 x L.60 mm
Art. 05.525.06
□ 12 mm



Liscio / Smooth
H.950 x L.75 mm
Art. 05.525.12
□ 12



Liscio / Smooth
H.950 mm.
Art. 05.526 □ 14
Art. 05.526.01 □ 12



Martellato / Hammered
H.950 mm.
Art. 05.527 □ 14
Art. 05.527.01 □ 12

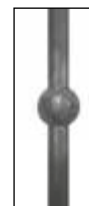

Sfera / Sphere
Ø22



H.950 mm
Art. 05.527.10 □ 12
H.1000 mm
Art. 05.527.11 □ 12

Sfera / Sphere Ø35

Art. 05.527.45 Ø12 H 950 mm
Art. 05.527.46 Ø12 H 1000 mm
Art. 05.527.47 Ø12 H 1200 mm

H 950 mm
Art. 05.527.50 Ø16
Art. 05.527.51 □ 12
Art. 05.527.52 □ 14

H 1000 mm
Art. 05.527.53 Ø16
Art. 05.527.54 □ 12
Art. 05.527.55 □ 14

H 1200 mm
Art. 05.527.56 Ø16
Art. 05.527.57 □ 12
Art. 05.527.58 □ 14

H 1500 mm
Art. 05.527.59 Ø16

Sfera / Sphere Ø30

Art. 05.527.60 Ø12 H 950 mm
Art. 05.527.61 Ø12 H 1000 mm
Art. 05.527.62 Ø12 H 1200 mm

Art. 05.527.64 Ø14 H 950 mm
Art. 05.527.65 Ø14 H 1000 mm
Art. 05.527.66 Ø14 H 1200 mm

Sfera / Sphere Ø25

H 950 mm
Art. 05.527.70 Ø12
Art. 05.527.71 Ø14

H 1000 mm
Art. 05.527.73 Ø12
Art. 05.527.74 Ø14

H 1200 mm
Art. 05.527.76 Ø12
Art. 05.527.77 Ø14

H 1500 mm
Art. 05.527.79 Ø12
Art. 05.527.80 Ø14

Art. 05.527.81 □ 12 H 950 mm
Art. 05.527.82 □ 12 H 1000 mm
Art. 05.527.83 □ 12 H 1200 mm

Sfera / Sphere Ø20

Art. 05.527.90 Ø12 H 950 mm
Art. 05.527.91 Ø12 H 1000 mm
Art. 05.527.92 Ø12 H 1200 mm



Lancia elettrosaldata /
Electro-welded spear

Lancia mod. /
Spear mod.
Art.13.072

Liscio / Smooth

H.950 mm.

Art. 05.528 12

Art. 05.528.01 14

H.1000 mm.

Art. 05.528.02 12

Art. 05.528.03 14

H.1200 mm.

Art. 05.528.04 12

Art. 05.528.05 14

H.1500 mm.

Art. 05.528.06 12

Art. 05.528.07 14



Lancia elettrosaldata /
Electro-welded spear

Lancia mod. /
Spear mod.
Art.13.060.02

Liscio / Smooth

H.950 mm.

Art. 05.529 12

Art. 05.529.01 14

H.1000 mm.

Art. 05.529.02 12

Art. 05.529.03 14

H.1200 mm.

Art. 05.529.04 12

Art. 05.529.05 14

H.1500 mm.

Art. 05.529.06 12

Art. 05.529.07 14



Lancia elettrosaldata /
Electro-welded spear

Lancia mod. /
Spear mod.
Art.13.056

Liscio / Smooth

H.950 mm.

Art. 05.530 12

Art. 05.530.01 14

H.1000 mm.

Art. 05.530.02 12

Art. 05.530.03 14

H.1200 mm.

Art. 05.530.04 12

Art. 05.530.05 14

H.1500 mm.

Art. 05.530.06 12

Art. 05.530.07 14



Lancia elettrosaldata /
Electro-welded spear

Lancia mod. /
Spear mod.
Art.13.098.02

Liscio / Smooth

H.950 mm.

Art. 05.531 12

Art. 05.531.01 14

H.1000 mm.

Art. 05.531.02 12

Art. 05.531.03 14

H.1200 mm.

Art. 05.531.04 12

Art. 05.531.05 14

H.1500 mm.

Art. 05.531.06 12

Art. 05.531.07 14



Lancia elettrosaldata /
Electro-welded spear

Lancia mod. /
Spear mod.
Art.13.092

Liscio / Smooth

H.950 mm

Art. 05.531.08 12 mm

Art. 05.531.09 14 mm

H.1000 mm

Art. 05.531.10 12 mm

Art. 05.531.11 14 mm

H.1200 mm

Art. 05.531.12 12 mm

Art. 05.531.13 14 mm

H.1500 mm

Art. 05.531.14 12 mm

Art. 05.531.15 14 mm



Lancia elettrosaldata /
Electro-welded spear

Lancia mod. /
Spear mod.
Art.13.077

H.950 mm

Art. 05.531.16 12 mm

Art. 05.531.17 14 mm

H.1000 mm

Art. 05.531.18 12 mm

Art. 05.531.19 14 mm

H.1200 mm

Art. 05.531.20 12 mm

Art. 05.531.21 14 mm

H.1500 mm

Art. 05.531.22 12 mm

Art. 05.531.23 14 mm



Lancia elettrosaldata /
Electro-welded spear

Lancia mod. /
Spear mod.
Art.13.061

H.950 mm

Art. 05.531.24 16 mm

H.1000 mm

Art. 05.531.25 16 mm

H.1200 mm

Art. 05.531.26 16 mm

H.1500 mm

Art. 05.531.27 16 mm



Lancia elettrosaldata /
Electro-welded spear

Lancia mod. /
Spear mod.
Art.13.077.06

H.950 mm

Art. 05.531.28 12 mm

Art. 05.531.29 14 mm

H.1000 mm

Art. 05.531.30 12 mm

Art. 05.531.31 14 mm

H.1200 mm

Art. 05.531.32 12 mm

Art. 05.531.33 14 mm

H.1500 mm

Art. 05.531.34 12 mm

Art. 05.531.35 14 mm



Art. 05.531.80
 12 H 950 mm
Art. 05.531.81
 12 H 1000 mm
Art. 05.531.82
 12 H 1200 mm



Art. 05.531.100
 12 H 1000 mm
Art. 05.531.101
 12 H 1200 mm

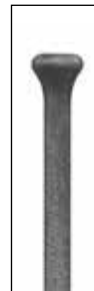

Art. 05.531.110
 12 H 1000 mm
Art. 05.531.111
 12 H 1200 mm

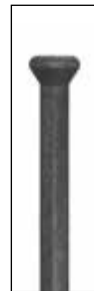

Art. 05.531.116
 12 H 1000 mm
Art. 05.531.117
 12 H 1200 mm



Art. 05.531.120
 12 H 1000 mm
Art. 05.531.121
 12 H 1200 mm

PANNELLI LISCI E PALETTI PER RECINZIONI
PLAIN PANEL UNITS AND STAKES FOR FENCES

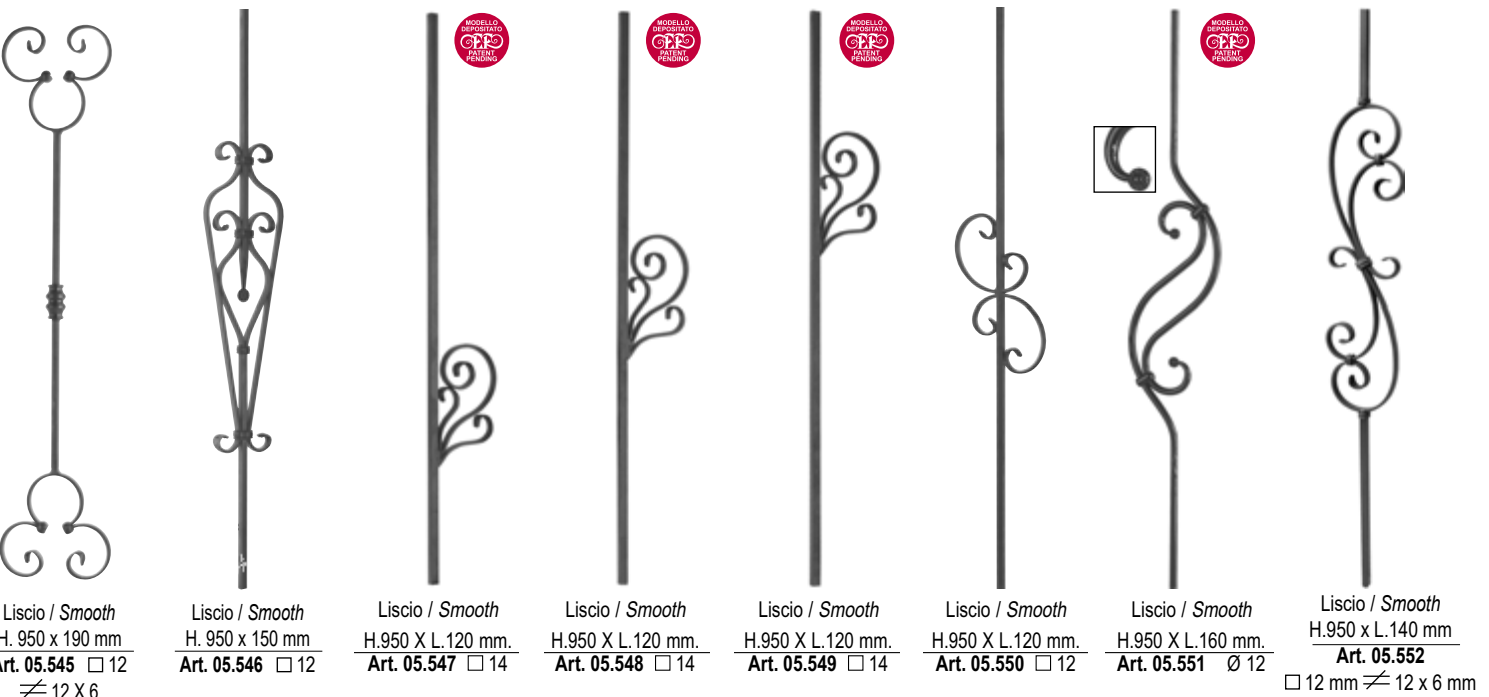
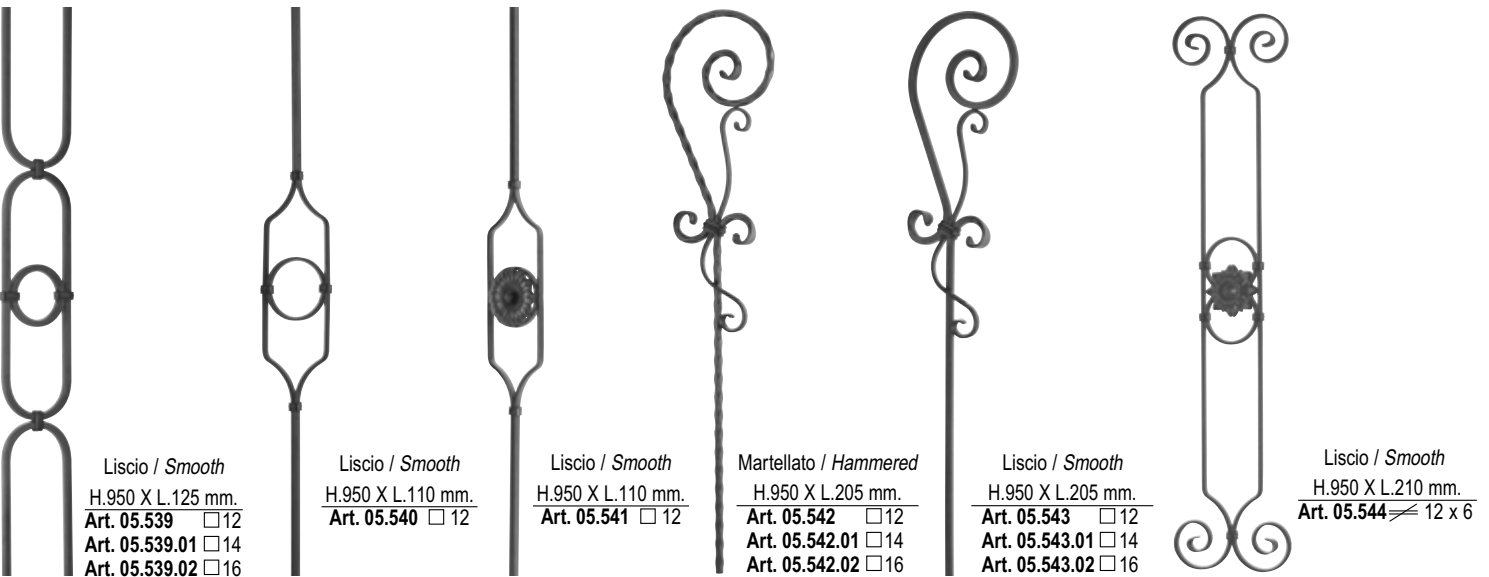
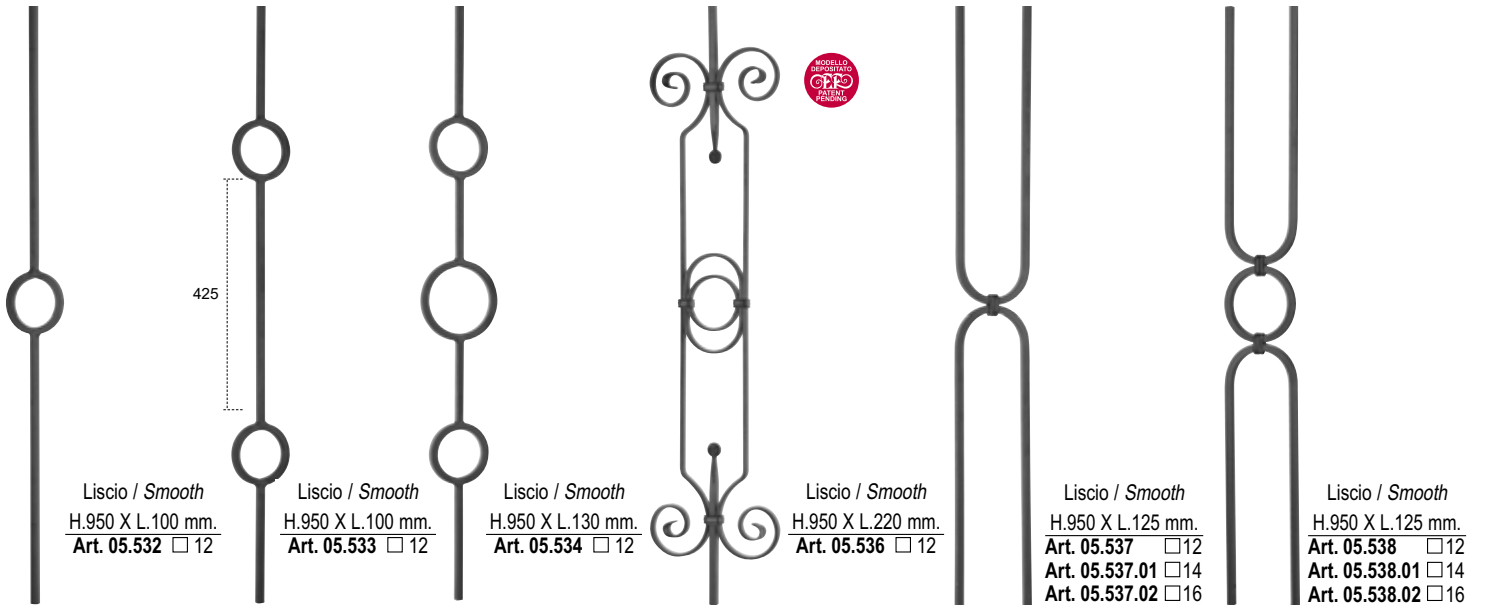

Tutte le parti di questo catalogo - foto comprese - sono di proprietà Euro-Fer. La riproduzione, anche parziale, è vietata in ogni forma e con ogni mezzo. / Every part of this catalogue - photos included - is Euro-Fer's property. All forms of copying are strictly prohibited.

PS
 pallina "a sole"
 sun ball



Martellato / *Hammered*

- H.950 mm.
 Art. 05.553 □ 12
 Art. 05.553.01 □ 14
 Art. 05.553.02 Ø 12
 Art. 05.553.03 Ø 14
 H.1000 mm.
 Art. 05.553.04 □ 12
 Art. 05.553.05 □ 14
 Art. 05.553.06 Ø 12
 Art. 05.553.07 Ø 14
 H.1200 mm.
 Art. 05.553.08 □ 12
 Art. 05.553.09 □ 14
 Art. 05.553.10 Ø 12
 Art. 05.553.11 Ø 14
 H.1500 mm.
 Art. 05.553.12 □ 12
 Art. 05.553.13 □ 14
 Art. 05.553.14 Ø 12
 Art. 05.553.15 Ø 14

Liscio / *Smooth*

- H.950 mm.
 Art. 05.554 □ 12
 Art. 05.554.01 □ 14
 Art. 05.554.02 Ø 12
 Art. 05.554.03 Ø 14
 H.1000 mm.
 Art. 05.554.04 □ 12
 Art. 05.554.05 □ 14
 Art. 05.554.06 Ø 12
 Art. 05.554.07 Ø 14
 H.1200 mm.
 Art. 05.554.08 □ 12
 Art. 05.554.09 □ 14
 Art. 05.554.10 Ø 12
 Art. 05.554.11 Ø 14
 H.1500 mm.
 Art. 05.554.12 □ 12
 Art. 05.554.13 □ 14
 Art. 05.554.14 Ø 12
 Art. 05.554.15 Ø 14

Tondo Corteccia
Bark Model
 H.950 mm

- Art. 05.555 Ø 12
 Art. 05.555.01 Ø 14
 H.1000 mm.
 Art. 05.555.02 Ø 12
 Art. 05.555.03 Ø 14
 H.1200 mm.
 Art. 05.555.04 Ø 12
 Art. 05.555.05 Ø 14
 H.1500 mm.
 Art. 05.555.06 Ø 12
 Art. 05.555.07 Ø 14

Liscio / *Smooth*

- H.950 mm.
 Art. 05.556 Ø 12
 Art. 05.556.01 Ø 14
 H.1000 mm.
 Art. 05.556.02 Ø 12
 Art. 05.556.03 Ø 14
 H.1200 mm.
 Art. 05.556.04 Ø 12
 Art. 05.556.05 Ø 14
 H.1500 mm.
 Art. 05.556.06 Ø 12
 Art. 05.556.07 Ø 14

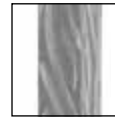

NEW



Liscio / *Smooth*
 H.950 X L.250 mm.
 Art. 05.560 Ø 10
 Art. 05.560.01 Ø 12



Liscio / *Smooth*
 H.950 x L.420 mm
 Art. 05.560.02 Ø 12 mm

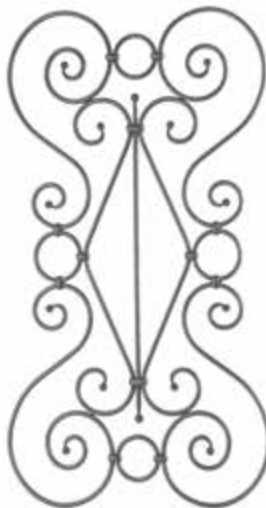

Liscio / *Smooth*
 H.950 X L.520 mm.
 Art. 05.561 Ø 10
 Art. 05.561.01 Ø 12



Art. 05.561.02

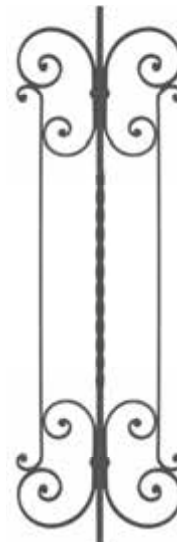

Liscio / *Smooth*
 H.1000 x L.310 mm
 Art. 05.561.05
 □ 12 mm ≠ 12 x 6 mm



Liscio / *Smooth*
 H.900 X L.175 mm.
 Art. 05.562 Ø 12



Tutte le parti di questo catalogo - foto comprese - sono di proprietà Euro-Fer. La riproduzione, anche parziale, è vietata in ogni forma e con ogni mezzo. / Every part of this catalogue - photos included - is Euro-Fer's property. All forms of copying are strictly prohibited.



NEW



NEW



NEW



Art. 05.562.20

Liscio / Smooth
H.1200 x L.420 mm ca.
Rosa / Rose Ø 10 mm
Paletto / Bar Ø 12 mm

Art. 05.562.21

Martellato / Hammered
H.1200 x L.420 mm ca.
Rosa / Rose Ø 12 mm
Paletto / Bar Ø 12 mm

Art. 05.562.22

Modello Corteccia / Bark Model
H.1200 x L.420 mm ca.
Rosa / Rose Ø 12 mm
Paletto / Bar Ø 12 mm

Art. SW 05.562.20

Liscio / Smooth
H.1200 x L.420 mm ca.
Rosa / Rose Ø 10 mm
Paletto / Bar Ø 12 mm

Art. 05.563.20

Liscio / Smooth
H.1200 x L.420 mm ca.
Rosa / Rose □ 10 mm
Paletto / Bar □ 12 mm

Art. SW 05.563.20

Liscio / Smooth
H.1200 x L.420 mm ca.
Rosa / Rose □ 10 mm
Paletto / Bar □ 12 mm



ROSE COLLECTION
CRYSTALS FROM SWAROVSKI®

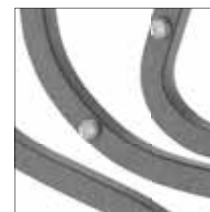

ROSE COLLECTION
CRYSTALS FROM SWAROVSKI®



Liscio / Smooth
H. 1000 X L. 400 mm
Art. 05.562.25
Rosa/rose Ø 12

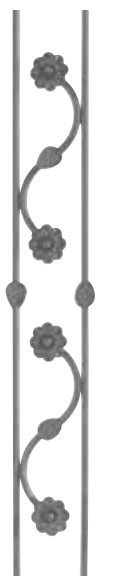

Liscio / Smooth
H.950 X L. 120 mm.
Art. 05.563 Ø 12

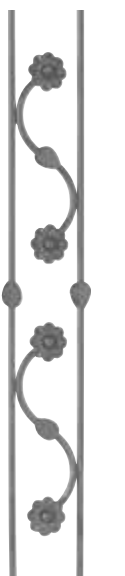

Liscio / Smooth
H.950 X L. 120 mm.
Art. 05.564 Ø 12

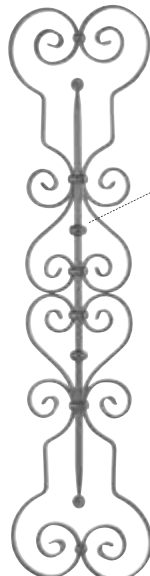

Liscio / Smooth
H.950 X L.245mm.
Art. 05.565 12 x 6
□ 12

Con Ricalcatura
New Forged
Element



Liscio / Smooth
H.950 x L.190 mm
Art. 05.566 Ø 12
Art. 05.567 □ 12



Liscio / Smooth
H.950 x L.240 mm
Art. 05.568 Ø 12
Art. 05.569 □ 12



Liscio / Smooth
H.950 x L.210 mm
Art. 05.570 Ø 12



Liscio / Smooth
 H.950 x L.230 mm
Art. 05.590 Ø 12
 Con fiori su ambo i lati /
 Flowers on both sides



Rigato / Fluted
 H.950 x L.100 mm
Art. 05.591 □ 14
Art. 05.591.01 □ 12
 Con fiori su ambo i lati /
 Flowers on both sides



Profilo a nuvola /
 Cloud profile

Profilo nuvola /
 Cloud profile
 H.950 mm
Art. 05.592 ≇ 20 x 12



Profilo nuvola /
 Cloud profile
 H.950 mm
Art. 05.592.01 ≇ 20 x 12



Forgiato / Forged
 H.950 mm
Art. 05.593 □ 14



Forgiato / Forged
 H.950 mm
Art. 05.593.01 □ 14

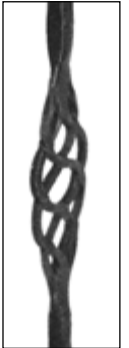

Pigna schiacciata /
 Flatted Basket



Liscio / Smooth
 H.950 x L.114 mm
Art. 05.600 □ 14

Con borchia in Acciaio Fuso / With Cast Steel stud Art.CI.13.921



Liscio / Smooth
 H.950 mm
Art. 05.700 Ø 16 x 1,5
 Tubo / Pipe bar

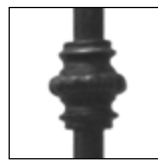

370

Liscio / Smooth
 H.950 mm
Art. 05.701 Ø 16 x 1,5
 Tubo / Pipe bar



Liscio / Smooth
 H.950 mm
Art. 05.702 Ø 16 x 1,5
 Tubo / Pipe bar



Liscio / Smooth
 H.1750 x L.320 mm
Art. 05.729.08
 □ 20 mm ≇ 16 x 8 mm



Liscio / Smooth
 H.1750 x L.320 mm
Art. 05.729.09
 □ 20 mm ≇ 16 x 8 mm

🌀 fiori da entrambi i lati / flowers on both sides



🌀 Liscio / Smooth
H. 950 X L. 190 mm.
Art. 05.800
□ 12
≠ 12 x 6



Liscio / Smooth
H. 950 X L. 210 mm.
Art. 05.801
Ø 12



🌀 Liscio / Smooth
H. 950 X L. 150 mm.
Art. 05.802
□ 12
Ø 12



🌀 Liscio / Smooth
H. 950 X L. 150 mm.
Art. 05.803
Ø 12



Liscio / Smooth
H. 950 X L. 150 mm.
Art. 05.804
Ø 10



Liscio / Smooth
H. 950 X L. 160 mm.
Art. 05.805
□ 12
≠ 12 x 6



Liscio / Smooth
H. 950 X L. 205 mm.
Art. 05.806
□ 10
≠ 10 x 5



Liscio / Smooth
H. 950 X L. 95 mm.
Art. 05.807
□ 12
≠ 12 x 6



Liscio / Smooth
H. 950 X L. 95 mm.
Art. 05.808
□ 12
≠ 12 x 6



Liscio / Smooth
H. 950 X L. 135 mm.
Art. 05.809
□ 12
≠ 12 x 6

Tutte le parti di questo catalogo - foto comprese - sono di proprietà Euro-Fer. La riproduzione, anche parziale, è vietata in ogni forma e con ogni mezzo. / Every part of this catalogue - photos included - is Euro-Fer's property. All forms of copying are strictly prohibited.

🌀 fiori da entrambi i lati / flowers on both sides

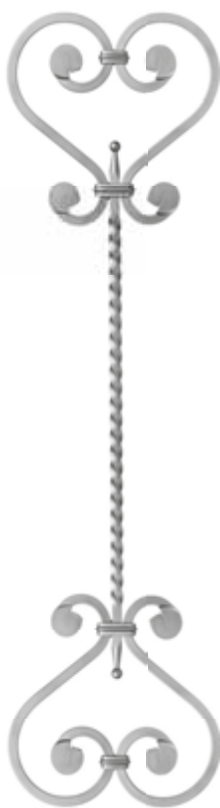

Liscio / Smooth
 H. 820 X L. 220 mm.
Art. 05.810
 □ 10



🌀 Liscio / Smooth
 H. 950 X L. 255 mm.
Art. 05.811 □ 14 ≠ 14 x 8
Art. 05.811.01 □ 16 ≠ 16 x 8



Liscio / Smooth
 H. 950 X L. 215 mm.
Art. 05.812
 □ 12 ≠ 12 x 6



Liscio / Smooth
 H. 950 X L. 130 mm.
Art. 05.813
 □ 12 ≠ 12 x 6

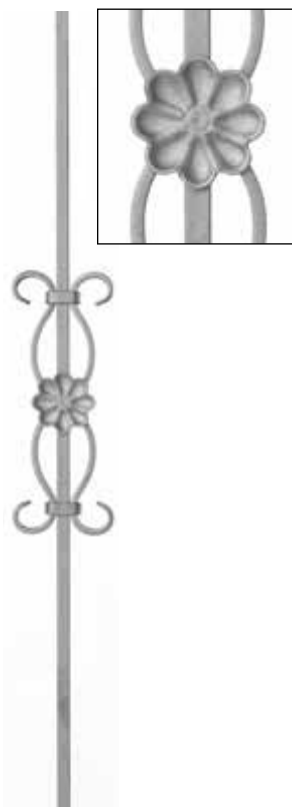

🌀 Liscio / Smooth
 H. 950 X L. 95 mm.
Art. 05.825
 □ 12 ≠ 12 x 6



Liscio / Smooth
 H. 1000 X L. 70 mm.
Art. 05.826
 □ 12 pigna / basket □ 12

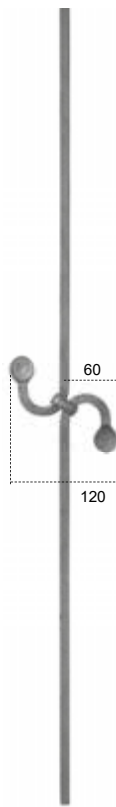

Liscio / Smooth
 H. 950 X L. 130 mm.
Art. 05.827
 □ 12

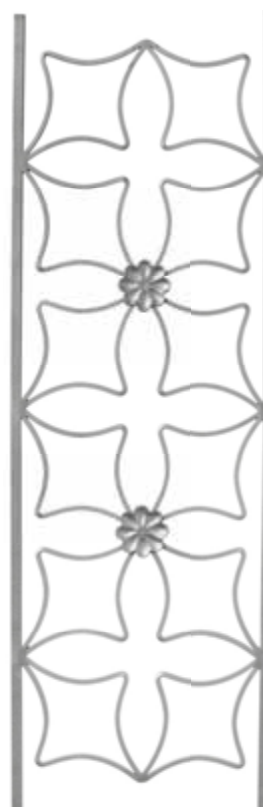

🌀 Liscio / Smooth
 H. 950 X L. 300 mm.
Art. 05.828
 □ 12 ≠ 12 x 6

🌀 fiori da entrambi i lati / flowers on both sides

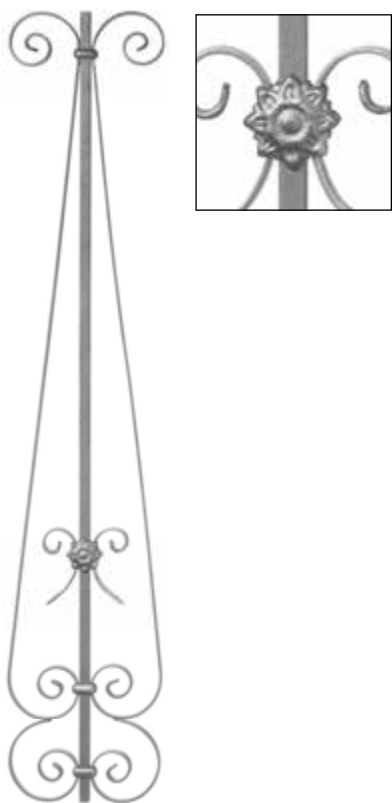

🌀 Liscio / Smooth
 H. 1220 X L. 235 mm.
 Art. 05.829
 □ 16
 ≠ 16 x 4



Liscio / Smooth
 H. 950 X L. 125 mm.
 Art. 05.830
 □ 12
 ≠ 12 x 4



Liscio / Smooth
 H. 950 X L. 120 mm.
 Art. 05.831
 □ 12
 ≠ 12 x 4



Liscio / Smooth
 H. 950 X L. 170 mm.
 Art. 05.832
 □ 12
 ≠ 12 x 6



H. 100 X L. 100 mm.
 Art. 02.050.50 ≠ 14 x 6



H. 110 X L. 110 mm.
 Art. 02.050.51 ≠ 12 x 6

H. 200 X L. 200 mm.
 Art. 02.051 □ 8 X 8
 Art. 02.052 □ 10 X 10
 Art. 02.053 □ 12 X 12

H. 80 X L. 80 mm.
 Art. 02.050.54 ≠ 12 x 6



H. 110 X L. 110 mm.
 Art. 02.050.55 ≠ 12 x 6





H.220 X L.220 mm.
Art. 02.050.56 \neq 12 x 6

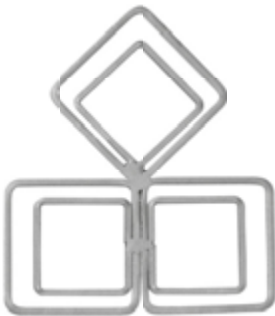

H.250 X L.220 mm.
Art. 02.050.60 \neq 12 x 6



Liscio / Smooth
H. 950 X L. 110 mm.
Art. 05.833
□ 12
 \neq 12 x 6



Liscio / Smooth
H. 950 X L. 110 mm.
Art. 05.834
□ 12
 \neq 12 x 6



Liscio / Smooth
H. 950 X L. 110 mm.
Art. 05.835
□ 12
 \neq 12 x 6



Liscio / Smooth
H. 950 X L. 110 mm.
Art. 05.836
□ 12
 \neq 12 x 6



Liscio / Smooth
H. 950 X L. 110 mm.
Art. 05.837
□ 12
 \neq 12 x 6



Liscio / Smooth
H. 950 X L. 110 mm.
Art. 05.838
□ 12
 \neq 12 x 6



Liscio / Smooth
H. 950 X L. 110 mm.
Art. 05.839
□ 12
 \neq 12 x 6

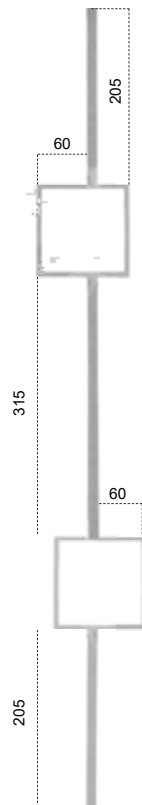

Liscio / Smooth
H. 950 X L. 110 mm.
Art. 05.840
□ 12
 \neq 12 x 6



Liscio / Smooth
H. 950 X L. 110 mm.
Art. 05.841
□ 12
 \neq 12 x 6



Liscio / Smooth
H. 950 X L. 220 mm.
Art. 05.842
□ 12
 \neq 12 x 6

🌀 fiori da entrambi i lati / flowers on both sides



Liscio / Smooth
H. 1000 X L. 183 mm.
Art. 05.843
spessore / thickness 6 mm



Liscio / Smooth
H. 950 X L. 150 mm.
Art. 05.844
□ 12 ≠ 12 x 6



Liscio / Smooth
H. 950 X L. 100 mm.
Art. 05.845
Ø 12



🌀 Liscio / Smooth
H. 950 X L. 100 mm.
Art. 05.846
Ø 12

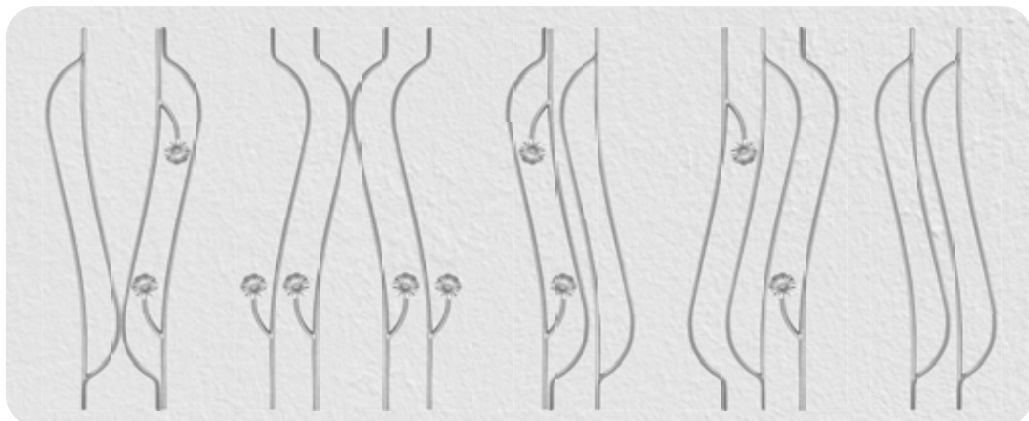



Mart./Hammered
H.950 mm.
Art. 06.001 12
Art. 06.002 14

Mart./Hammered
H.950 mm.
Art. 06.003
 12 X 12

Mart./Hammered
H.950 mm.
Art. 06.004
 12 X 12

Mart./Hammered
H.950 mm.
Art. 06.005
 12 X 12

Mart./Hämmered
H.950 mm.
Art. 06.006
 12 X 12

Mart./Hämmered
H.950 mm.
Art. 06.007
 12 X 12

Mart./Hammered
H.950 mm.
Art. 06.008 12
Art. 06.008.01 14
Art. 06.008.ES 12
Art. 06.008.01.ES 14

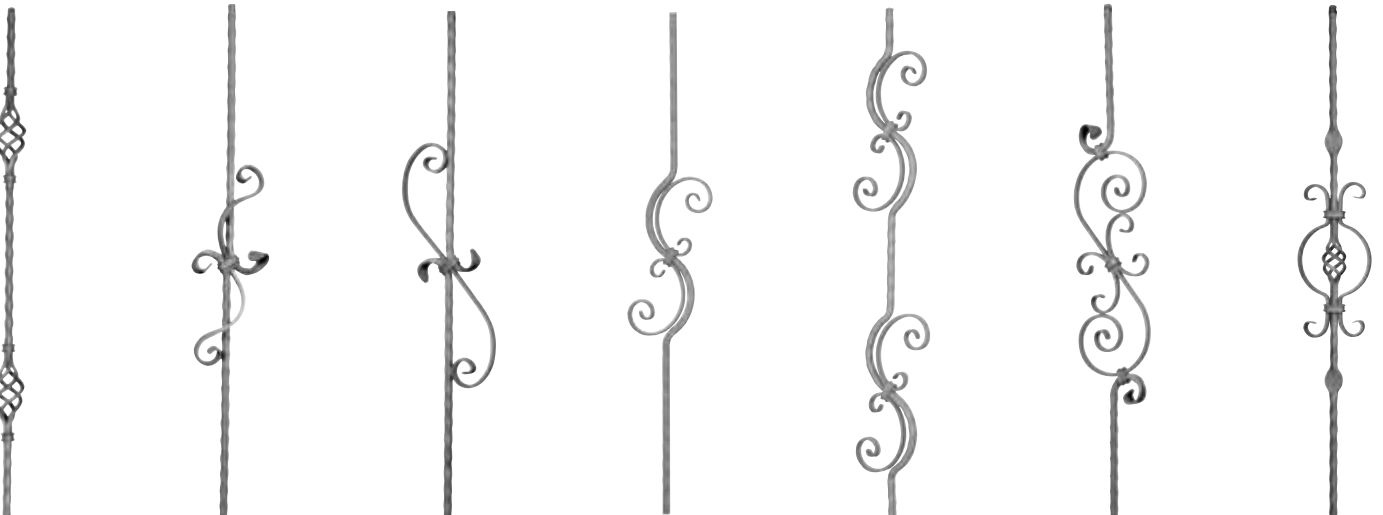

Mart./Hammered
H.950 mm.
Art. 06.009 12
Art. 06.009.01 14
Art. 06.009.ES 12
Art. 06.009.01.ES 14

Mart./Hammered
H.950 X L.130 mm.
Art. 06.010
 12 12 X 6

Mart./Hammered
H.950 X L.200 mm.
Art. 06.011
 12 12 X 6

Mart./Hammered
H.950 X L.150 mm.
Art. 06.012
 12 12 X 6
Liscio / Smooth
Art. 06.012.01
 12 12 X 6

Mart./Hammered
H.950 X L.150 mm.
Art. 06.013
 12 12 X 6
Liscio / Smooth
Art. 06.013.01
 12 12 X 6

Mart./Hammered
H.950 X L.140 mm.
Art. 06.014
 12 12 X 6
Art. 06.014.01
 14 14 X 6

Mart./Hammered
H.950 X L.135 mm.
Art. 06.015
 12 12 X 6

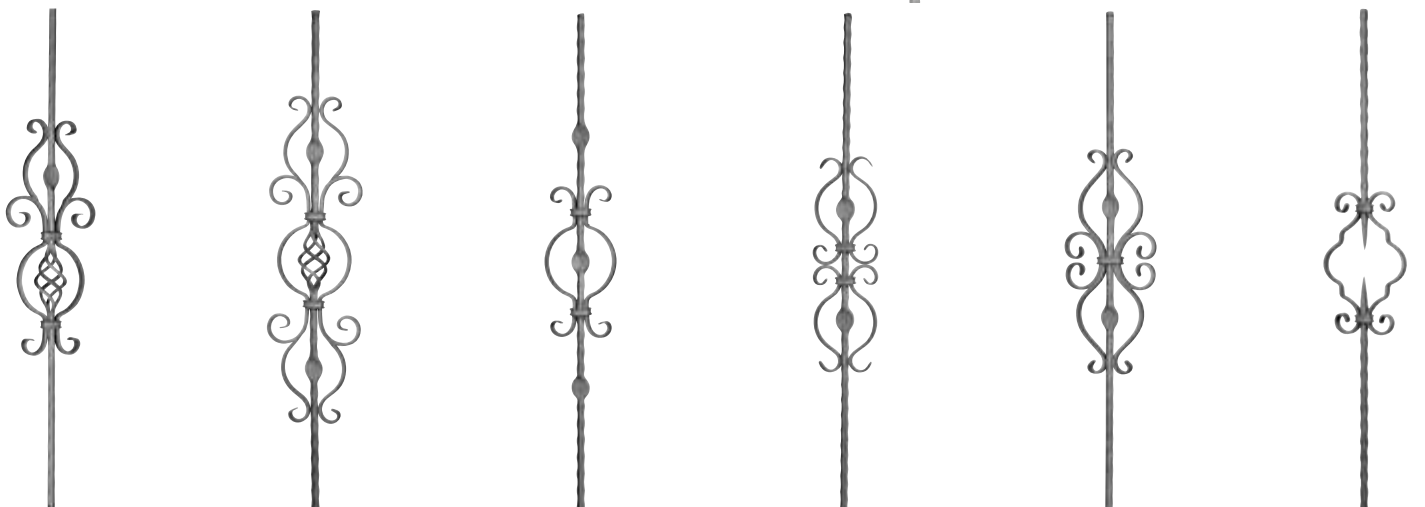

Mart./Hammered
H.950 X L.170 mm.
Art. 06.016
 12 12 X 6

Mart./Hammered
H.950 X L.170 mm.
Art. 06.017
 12 12 X 6

Mart./Hammered
H.950 X L.135 mm.
Art. 06.018
 12 12 X 6

Mart./Hammered
H.950 X L.120 mm.
Art. 06.019
 12 12 X 6

Mart./Hammered
H.950 X L.170 mm.
Art. 06.020
 12 12 X 6

Mart./Hammered
H.950 X L.165 mm.
Art. 06.021
 12 12 X 6

Tutte le parti di questo catalogo - foto comprese - sono di proprietà Euro-Fer. La riproduzione, anche parziale, è vietata in ogni forma e con ogni mezzo. / Every part of this catalogue - photos included - is Euro-Fer's property. All forms of copying are strictly prohibited.

**PANNELLI MARTELLATI
HAMMERED PANELS**



Mart./Hammered
H.950 X L.165 mm.
Art. 06.023
□ 12 ≠ 12 X 6



Mart./Hammered
H. 950 X L.165 mm.
Art. 06.024
□ 12 ≠ 12 x 6 mm



H.950 X L.185 mm.
Art. 06.025
□ 12 X 12
Mart./Hammered



H.950 X L.160 mm.
Art. 06.026
□ 12 ≠ 12 X 6
Mart./Hammered



H.950 X L.220 mm.
Art. 06.027
□ 12 ≠ 12 X 6
Mart./Hammered



H.950 mm.
Art. 06.028
□ 12 X 12
Mart./Hammered



Mart./Hammered
H.950 X L.150 mm.
Art. 06.029
□ 12 ≠ 12 X 6



Mart./Hammered
H.950 X L.215 mm.
Art. 06.029.01
□ 12 ≠ 12 X 6
Art. 06.029.08
□ 14 ≠ 14 X 6
Art. 06.029.09
□ 16 ≠ 16 X 6



Mart./Hammered
H.950 X L.275 mm.
Art. 06.029.02
□ 12 ≠ 12 X 6
Art. 06.029.10
□ 14 ≠ 14 X 6
Art. 06.029.11
□ 16 ≠ 16 X 6



Mart./Hammered
H.950 X L.275 mm.
Art. 06.029.03
□ 12 ≠ 12 X 6
Art. 06.029.12
□ 14 ≠ 14 X 6
Art. 06.029.13
□ 16 ≠ 16 X 6



Martellato/Hammered
H.950 X L.115 mm.
Art. 06.029.04
□ 12 ≠ 12 X 6



Martellato/Hammered
H.950 X L.200 mm.
Art. 06.029.05
□ 14 ≠ 14 X 6



Martellato/Hammered
H.950 X L.215 mm.
Art. 06.029.06
□ 14 ≠ 14 X 6



Martellato/Hammered
H.950 X L.205 mm.
Art. 06.029.07
□ 14 ≠ 14 X 6



Martellato / Hammered
H.950 x L.260 mm
Art. 06.029.14
□ 12 mm ≠ 12 x 6



Martellato kigato / Hammered Fluted
H.950 x L.210 mm
Art. 06.029.15
□ 12 mm ≠ 12 x 6



UR
Mart. / Hammered
H.1000 mm.
Art. 06.030 □ 12
Art. 06.031 □ 14
Art. 06.032 □ 16



UR
Liscio / Smooth
H.1000 mm.
Art. 06.030.01 □ 12
Art. 06.030.02 □ 14
Art. 06.030.03 □ 16



CR
Tondo / Round
H.1200 mm.
Art. 06.032.01 Ø 12
Art. 06.032.02 Ø 14
Art. 06.032.03 Ø 16



CR
Liscio / Smooth
H.1200 mm.
Art. 06.032.04 □ 12
Art. 06.032.05 □ 14
Art. 06.032.06 □ 16



CR
Batt. 4 lati/Beaten on 4 sides
H.1200 mm.
Art. 06.032.07 □ 12
Art. 06.032.08 □ 14
Art. 06.032.09 □ 16
H.1500 mm.
Art. 06.032.10 □ 16

Tutte le parti di questo catalogo - foto comprese - sono di proprietà Euro-Fer. La riproduzione, anche parziale, è vietata in ogni forma e con ogni mezzo. / Every part of this catalogue - photos included - is Euro-Fer's property. All forms of copying are strictly prohibited.

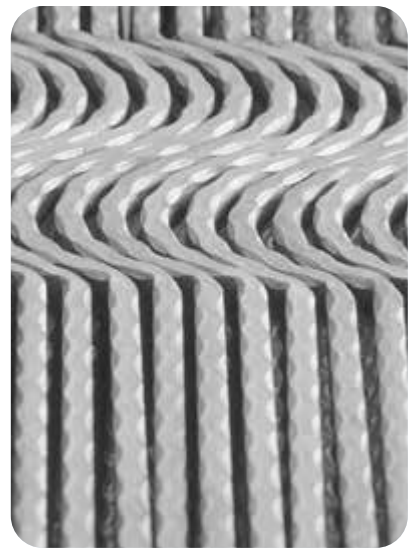
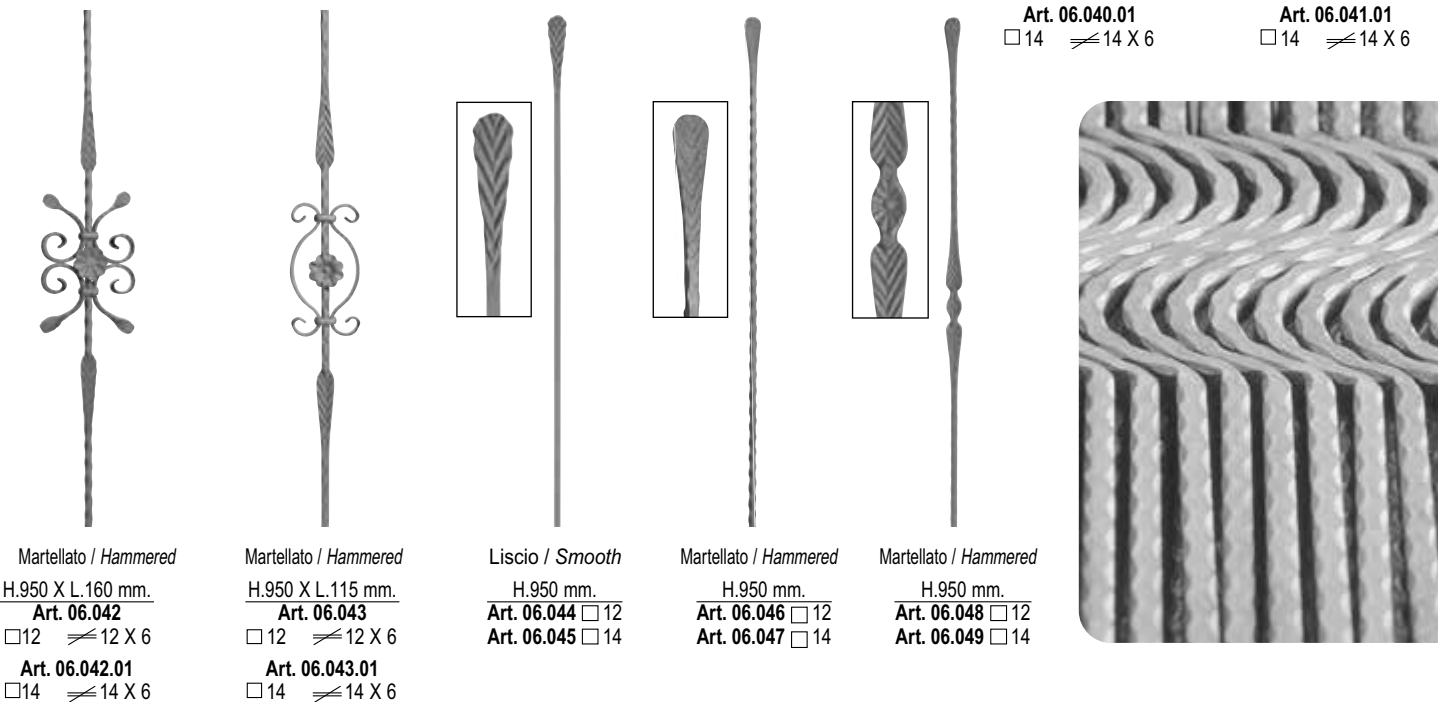
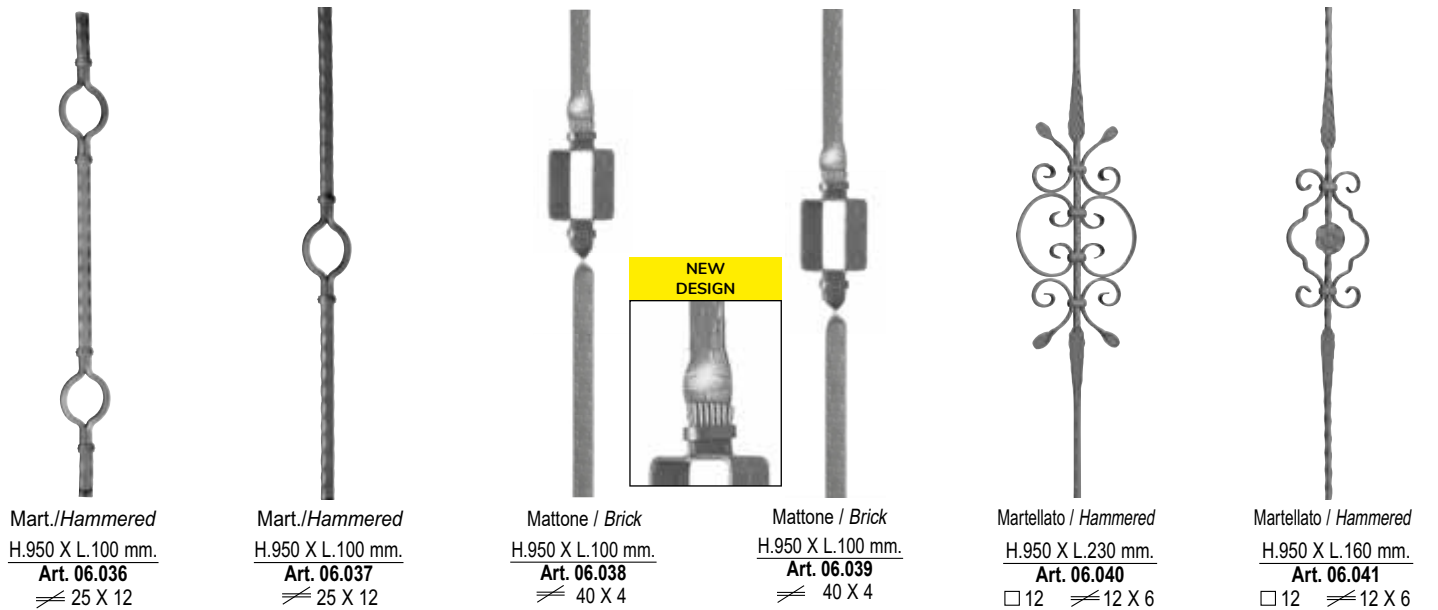
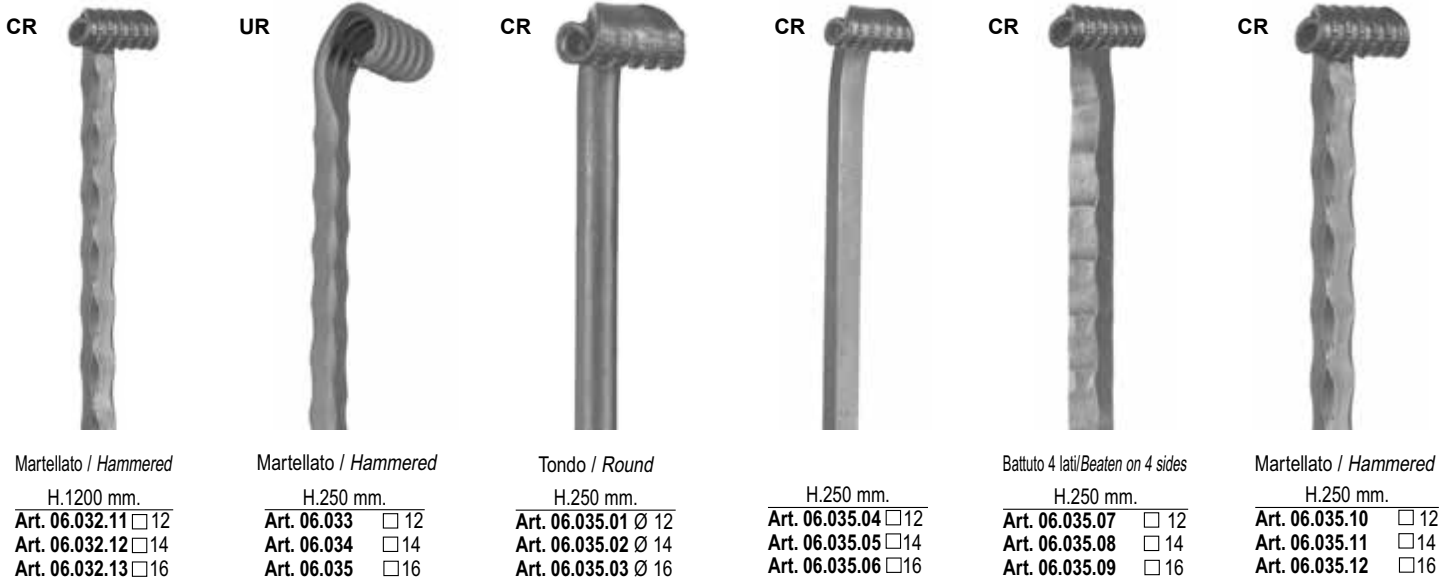

Tutte le parti di questo catalogo - foto comprese - sono di proprietà Euro-Fer. La riproduzione, anche parziale, è vietata in ogni forma e con ogni mezzo. / Every part of this catalogue - photos included - is Euro-Fer's property. All forms of copying are strictly prohibited.



Martellato / Hammered
H.950 X L.170 mm.
Art. 06.050 12
Art. 06.050.01 14



Martellato / Hammered
H.950 X L.155 mm.
Art. 06.051 12
Art. 06.051.01 14



Martellato / Hammered
H.950 X L.155 mm.
Art. 06.052 12
Art. 06.052.01 14



Martellato / Hammered
H.950 X L.200 mm.
Art. 06.053 12
Art. 06.054 14



Martellato / Hammered
H.950 X L.125 mm.
Art. 06.055 12
Art. 06.056 14



Tondo / Round
H.950 mm.
Art. 06.057 \varnothing 12
Art. 06.058 \varnothing 14



Martellato / Hammered
H.1100 mm.
Art. 06.059 20
Art. 06.060 25

Vedi Art. / See Article 11.053.20 / 11.053.21



Martellato / Hammered
H.1000 X L.150 mm.
Art. 06.061 12
Art. 06.062 14



Martellato / Hammered
H.1000 X L.150 mm.
Art. 06.063 12
Art. 06.064 14



H.950 X L.105 mm.
Art. 06.065 12
Art. 06.066 14



H.950 X L.105 mm.
Art. 06.067 12
Art. 06.068 14



Martellato / Hammered
H.950 X L.105 mm.
Art. 06.069 12
Art. 06.070 14



Martellato / Hammered
H.950 X L.105 mm.
Art. 06.071 12
Art. 06.072 14



Martellato / Hammered
H.950 X L.105 mm.
Art. 06.073 12
Art. 06.074 14



Martellato / Hammered
H.950 X L.160 mm.
Art. 06.075 12
Art. 06.076 14

160



Martellato / Hammered
H.950 mm.
Art. 06.077 14



Martellato / *Hammered*
H.950 X L.100 mm.
Art. 06.078 □ 12



Martellato / *Hammered*
H.950 X L.100 mm.
Art. 06.079 □ 12



Martellato / *Hammered*
H.950 X L.180 mm.
Art. 06.080 □ 12



Martellato / *Hammered*
H.950 X L.260 mm.
Art. 06.081 □ 14



Martellato / *Hammered*
H.950 X L.260 mm.
Art. 06.082 □ 14



Martellato / *Hammered*
H. 1000 X L. 115 mm.
Art. 06.083
□ 12
≠ 12 x 6
Mod. Scala / *Scala Model*









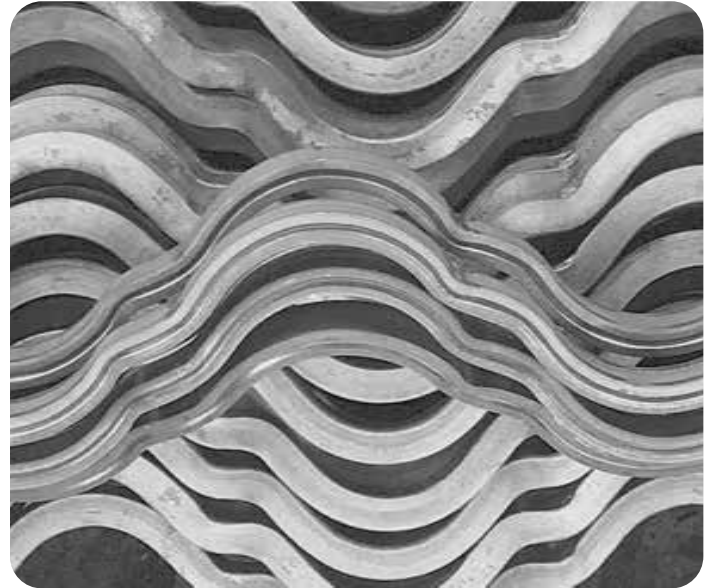
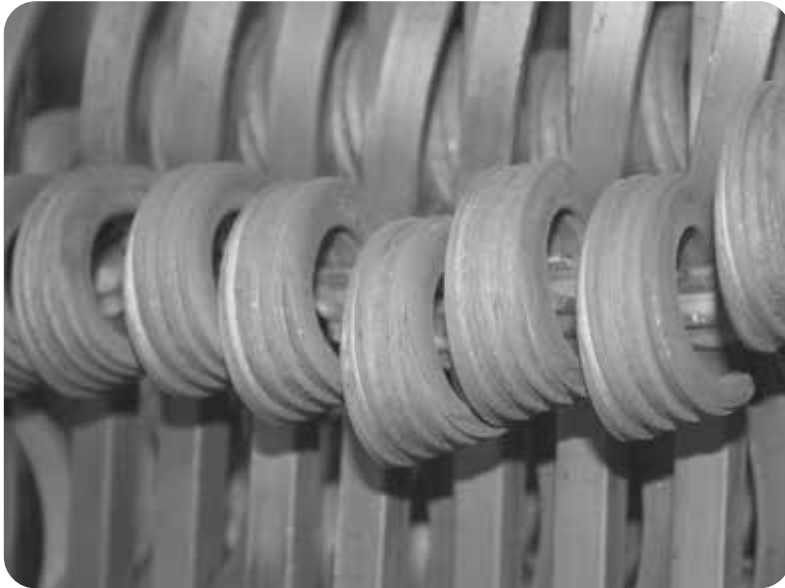







Martellato / *Hammered*
H. 1000 X L. 115 mm.
Art. 06.084
□ 12
≠ 12 x 6
Mod. Scala / *Scala Model*



Mod. Scala / *Scala Model*
H. 950 X L. 145 mm.
Art. 06.085
≠ 16 x 6



 Modello Liquirizia / Liquorice Model	  Modello Liquirizia / Liquorice Model	 Modello Liquirizia / Liquorice Model	 Modello Liquirizia / Liquorice Model	 Modello Liquirizia / Liquorice Model		
H.950 mm. Art. 07.001 <input type="checkbox"/> 12 Art. 07.001.01 <input type="checkbox"/> 14 Art. 07.001.05 <input type="checkbox"/> 16	H.950 mm. Art. 07.001.02 <input type="checkbox"/> 12 Art. 07.001.03 <input type="checkbox"/> 14 Art. 07.001.06 <input type="checkbox"/> 16	Modello Liquirizia / Liquorice Model H.950 mm Art. 07.001.07 <input type="checkbox"/> 12 Art. 07.001.08 <input type="checkbox"/> 14	Modello Liquirizia / Liquorice Model H.950 mm Art. 07.001.09 <input type="checkbox"/> 12 Art. 07.001.10 <input type="checkbox"/> 14	Modello Liquirizia / Liquorice Model H.950 mm Art. 07.001.11 <input type="checkbox"/> 12 Art. 07.001.12 <input type="checkbox"/> 14 Art. 07.001.13 <input type="checkbox"/> 16	H.950 mm. Art. 07.002 <input type="checkbox"/> 12 Art. 07.002.01 <input type="checkbox"/> 14 Art. 07.002.03 <input type="checkbox"/> 16	H.950 mm. Art. 07.003 <input type="checkbox"/> 12 Art. 07.003.01 <input type="checkbox"/> 14 Art. 07.003.06 <input type="checkbox"/> 16

  Particolare rigato Fluted detail					
H.950 mm. Art. 07.002.02 <input type="checkbox"/> 12 ≧ 16 x 8	H.950 mm. Art. 07.003.02 <input type="checkbox"/> 12 ≧ 16 x 8	H.950 mm. Art. 07.003.05 <input type="checkbox"/> 12 ≧ 16 x 8	H.950 X L.140 mm. Art. 07.004 <input type="checkbox"/> 12 ≧ 12 X 6	H.950 X L.140 mm. Art. 07.005 <input type="checkbox"/> 12 ≧ 12 X 6	H.950 X L.100 Art. 07.006 <input type="checkbox"/> 12

Tutte le parti di questo catalogo - foto comprese - sono di proprietà Euro-Fer. La riproduzione, anche parziale, è vietata in ogni forma e con ogni mezzo. / Every part of this catalogue - photos included - is Euro-Fer's property. All forms of copying are strictly prohibited.



H.950 X L.105 mm.
Art. 07.007 □ 12



H.950 X L.115 mm.
Art. 07.007.01 □ 12



H.950 mm.
Art. 07.008 □ 12



H.950 mm.
Art. 07.009 □ 12



H.950 X L.165 mm.
Art. 07.010
□ 12 ≠ 12 X 6



H.950 X L.165 mm.
Art. 07.011
□ 12 ≠ 12 X 6



H.950 X L.145 mm.
Art. 07.012
□ 12 ≠ 12 X 6



H.950 X L.70 mm.
Art. 07.013 □ 12



H.950 X L.190 mm.
Art. 07.014
□ 12 ≠ 12 X 6



H.950 X L.145 mm.
Art. 07.015
□ 12 ≠ 12 X 6



H.950 X L.215 mm.
Art. 07.016
□ 12 ≠ 12 X 6



H.950 X L.170 mm.
Art. 07.017
□ 12 ≠ 12 X 6



H.950 X L.140 mm.
Art. 07.018
□ 12 ≠ 12 X 6



H.950 X L.230 mm.
Art. 07.019
□ 12 ≠ 12 X 6
Art. 07.019.01
□ 14 ≠ 14 X 6



Liscio / Smooth
H.950 x L.230 mm
Art. 07.019.02 □ 12
Art. 07.019.03 □ 14



H.950 X L.205 mm.
Art. 07.020
□ 12 ≠ 12 X 6
Art. 07.020.01
□ 14 ≠ 14 X 6



H.950 X L.145 mm.
Art. 07.021
□ 12 ≠ 12 X 6



H.850 X L.200 mm.
Art. 07.022
□ 12 ≠ 12 X 6



H.850 X L.200 mm.
Art. 07.023
□ 12 ≠ 12 X 6

Tutte le parti di questo catalogo - foto comprese - sono di proprietà Euro-Fer. La riproduzione, anche parziale, è vietata in ogni forma e con ogni mezzo. / Every part of this catalogue - photos included - is Euro-Fer's property. All forms of copying are strictly prohibited.

PANNELLI RIGATI CON PROFILO A NUVOLA
FLUTED PANELS "CLOUD"

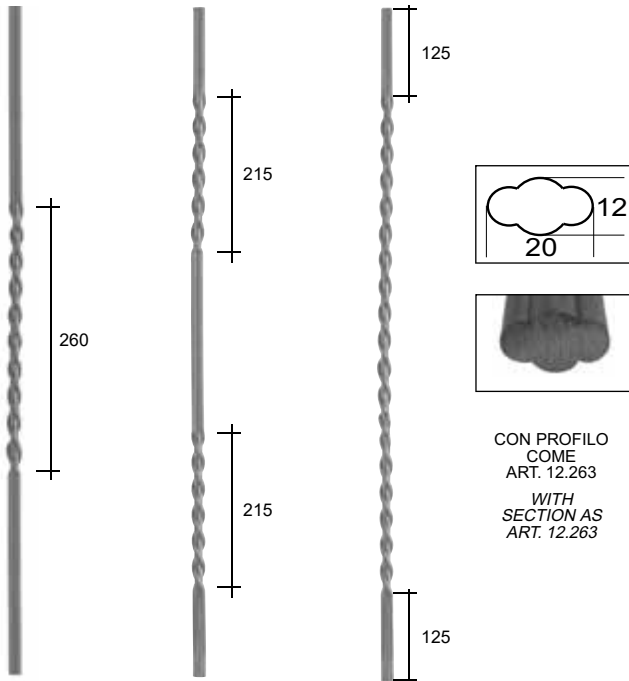

CON PROFILO
COME
ART. 12.263
WITH
SECTION AS
ART. 12.263

Rigato / Fluted
H.950 mm.
Art. 07.050
20 x 12

Rigato / Fluted
H.950 mm.
Art. 07.051
20 x 12

Rigato / Fluted
H.950 mm.
Art. 07.052
20 x 12



Rigato / Fluted
H.950 x L.100 mm
Art. 05.591 □ 14
Art. 05.591.01 □ 12
Con fiori su ambo i lati /
Flowers on both sides



H.900 mm
Art. 07.060 2 x Ø 8

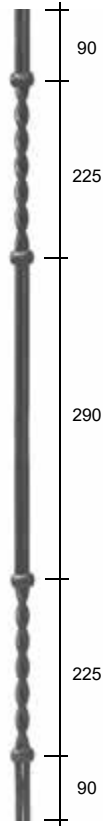

H. 920 mm
Art. 07.061
2 x Ø 8



H.900 x L.120 mm
Art. 07.064 2 x Ø 8



NEW

Rigato / Fluted
H. 950 X L. 120 mm.
Art. 07.066
□ 12
≠ 12 x 6



NEW

Rigato / Fluted
H. 950 X L. 120 mm.
Art. 07.067
□ 12
≠ 12 x 6



Tubo Liscio /
Smooth Tube
H.900 mm
Art. TB.21.900 Ø 30



Tubo Liscio /
Smooth Tube
H.900 mm
Art. TB.21.901 Ø 30



Tubo Liscio /
Smooth Tube
H.900 mm
Art. TB.21.902 Ø 30



Tubo Liscio /
Smooth Tube
H.900 mm
Art. TB.21.903 Ø 30



Tubo Liscio /
Smooth Tube
H.1200 mm
Art. TB.24.400 Ø 40

Tutte le parti di questo catalogo - foto comprese - sono di proprietà Euro-Fer. La riproduzione, anche parziale, è vietata in ogni forma e con ogni mezzo. / Every part of this catalogue - photos included - is Euro-Fer's property. All forms of copying are strictly prohibited.



sezione ferro iron section	tipo ferro iron type	codice code	interasse centre distance	nr. fori nr. of holes	tipo fori kind of holes	luce hole to hole	trattamento finishing
■ 12x12	liscio / smooth	08.006.01	120 mm	16 fori / holes	□ 12x12	108 mm	grezzo / raw
■ 14x14	liscio / smooth	08.119	125 mm	15 fori / holes	□ 14x14	111 mm	grezzo / raw
■ 14x14	liscio / smooth ES	08.119.01	125 mm	14 fori / holes	□ 14x14	111 mm.	grezzo / raw
■ 14x14	liscio / smooth	08.001	140 mm	14 fori / holes	□ 14x14	126 mm	grezzo / raw
■ 16x16	liscio / smooth	08.120	125 mm	15 fori / holes	□ 16x16	109 mm	grezzo / raw
■ 16x16	liscio / smooth	08.131	125 mm	15 fori / holes	□ 14x14	111 mm	grezzo / raw
■ 16x16	liscio / smooth ES	08.120.01	135 mm	14 fori / holes	□ 16x16	119 mm	grezzo / raw
■ 16x16	liscio / smooth	08.002	150 mm	13 fori / holes	□ 16x16	134 mm	grezzo / raw
■ 18x18	liscio / smooth	08.121	128 mm	14 fori / holes	□ 18x18	110 mm	grezzo / raw
■ 18x18	liscio / smooth	08.003	160 mm	12 fori / holes	□ 18x18	142 mm	grezzo / raw
■ 20x20	liscio / smooth	08.122	130 mm	13 fori / holes	□ 20x20	110 mm	grezzo / raw
■ 20x20	liscio / smooth	08.004	170 mm	11 fori / holes	□ 20x20	150 mm	grezzo / raw
■ 22x22	liscio / smooth	08.005	170 mm	11 fori / holes	□ 22x22	148 mm	grezzo / raw
■ 25x25	liscio / smooth	08.006	180 mm	10 fori / holes	□ 25x25	155 mm	grezzo / raw

lunghezza standard 2000 mm.
standard size 2000 mm.

- quadro / square
- ◇ foro quadro in obliquo / slanting square hole
- ∅ tondo / round
- ∅ foro ovale / oval hole
- foro rettangolo / rectangular hole
- ES** foro largo / larger hole

Riassunto barre forate in ordine di codice a pag. 270
Summary holed bars in order of code on pag. 270



sezione ferro <i>iron section</i>	tipo ferro <i>iron type</i>	codice <i>code</i>	interasse centre distance	nr. fori <i>nr. of holes</i>	tipo fori <i>kind of holes</i>	luce <i>hole to hole</i>	trattamento <i>finishing</i>
■ 14x14	liscio / smooth	08.123	128 mm	14 fori / holes	◇14x14 sullo spigolo / on the edge	108 mm	grezzo / raw
■ 14x14	liscio / smooth	08.007	140 mm	14 fori / holes	◇14x14 sullo spigolo / on the edge	120 mm	grezzo / raw
■ 16x16	liscio / smooth	08.124	130 mm	14 fori / holes	◇16x16 sullo spigolo / on the edge	107 mm	grezzo / raw
■ 16x16	liscio / smooth	08.008	150 mm	13 fori / holes	◇16x16 sullo spigolo / on the edge	127 mm	grezzo / raw
■ 18x18	liscio / smooth	08.125	132 mm	14 fori / holes	◇18x18 sullo spigolo / on the edge	107 mm	grezzo / raw
■ 18x18	liscio / smooth	08.009	160 mm	12 fori / holes	◇18x18 sullo spigolo / on the edge	135 mm	grezzo / raw
■ 20x20	liscio / smooth	08.126	134 mm	13 fori / holes	◇20x20 sullo spigolo / on the edge	106 mm	grezzo / raw
■ 20x20	liscio / smooth	08.010	170 mm	11 fori / holes	◇20x20 sullo spigolo / on the edge	142 mm	grezzo / raw
■ 22x22	liscio / smooth	08.011	170 mm	11 fori / holes	◇22x22 sullo spigolo / on the edge	139 mm	grezzo / raw
■ 25x25	liscio / smooth	08.012	180 mm	10 fori / holes	◇25x25 sullo spigolo / on the edge	145 mm	grezzo / raw



■ 14x14	liscio / smooth	08.127	128 mm	14 fori / holes	◇14x14	108 mm	grezzo / raw
■ 14x14	liscio / smooth ES	08.127.01	135 mm	14 fori / holes	◇14x14	115 mm	grezzo / raw
■ 14x14	liscio / smooth	08.013	140 mm	14 fori / holes	◇14x14	120 mm	grezzo / raw
■ 16x16	liscio / smooth ES	08.128.02	125 mm	15 fori / holes	◇16x16	102 mm	grezzo / raw
■ 16x16	liscio / smooth	08.128	130 mm	14 fori / holes	◇16x16	107 mm	grezzo / raw
■ 16x16	liscio / smooth ES	08.128.01	135 mm	14 fori / holes	◇16x16	112 mm	grezzo / raw
■ 16x16	liscio / smooth	08.014	150 mm	13 fori / holes	◇16x16	127 mm	grezzo / raw
■ 18x18	liscio / smooth	08.129	132 mm	14 fori / holes	◇18x18	107 mm	grezzo / raw
■ 18x18	liscio / smooth ES	08.129.01	135 mm	14 fori / holes	◇18x18	110 mm	grezzo / raw
■ 18x18	liscio / smooth	08.015	160 mm	12 fori / holes	◇18x18	135 mm	grezzo / raw
■ 20x20	liscio / smooth	08.130	135 mm	13 fori / holes	◇20x20	107 mm	grezzo / raw
■ 20x20	liscio / smooth	08.016	170 mm	11 fori / holes	◇20x20	142 mm	grezzo / raw
■ 22x22	liscio / smooth	08.017	170 mm	11 fori / holes	◇22x22	139 mm	grezzo / raw
■ 25x25	liscio / smooth	08.018	180 mm	10 fori / holes	◇25x25	145 mm	grezzo / raw



Ø 14	liscio / smooth	08.019	140 mm	14 fori / holes	θ 14x26 mm ovale / oval		grezzo / raw
Ø 16	liscio / smooth	08.020	150 mm	13 fori / holes	θ 16x28 mm ovale / oval		grezzo / raw
Ø 18	liscio / smooth	08.021	160 mm	12 fori / holes	θ 18x30 mm ovale / oval		grezzo / raw
Ø 20	liscio / smooth	08.022	170 mm	11 fori / holes	θ 20x33 mm ovale / oval		grezzo / raw

lunghezza standard 2000 mm.
standard size 2000 mm.

□	quadro / square
◇	foro quadro in obliquo / slanting square hole
Ø	tondo / round
θ	foro ovale / oval hole
▭	foro rettangolo / rectangular hole
ES	foro largo / larger hole

Riassunto barre forate in ordine di codice a pag. 270
Summary holed bars in order of code on pag. 270



sezione ferro <i>iron section</i>	tipo ferro <i>iron type</i>	codice <i>code</i>	interasse <i>centre distance</i>	nr. fori <i>nr. of holes</i>	tipo fori <i>kind of holes</i>	luce <i>hole to hole</i>	trattamento <i>finishing</i>
Ø 12	liscio / smooth	08.029.01	120 mm	16 fori / holes	Ø 12	108 mm	grezzo / raw
Ø 14	liscio / smooth	08.115	125 mm	15 fori / holes	Ø 14	111 mm	grezzo / raw
Ø 14	liscio / smooth	08.115.01	130 mm	14 fori / holes	Ø 14	116 mm	grezzo / raw
Ø 14	liscio / smooth	08.023	140 mm	14 fori / holes	Ø 14	126 mm	grezzo / raw
Ø 16	liscio / smooth	08.116	125 mm	15 fori / holes	Ø 16	109 mm	grezzo / raw
Ø 16	liscio / smooth	08.132	125 mm	15 fori / holes	Ø 14	111 mm	grezzo / raw
Ø 16	liscio / smooth	08.024	150 mm	13 fori / holes	Ø 16	134 mm	grezzo / raw
Ø 16	liscio / smooth	08.116.01	160 mm	12 fori / holes	Ø 16	144 mm	grezzo / raw
Ø 18	liscio / smooth	08.117	128 mm	14 fori / holes	Ø 18	110 mm	grezzo / raw
Ø 18	liscio / smooth	08.025	160 mm	12 fori / holes	Ø 18	142 mm	grezzo / raw
Ø 20	liscio / smooth	08.118	130 mm	13 fori / holes	Ø 20	110 mm	grezzo / raw
Ø 20	liscio / smooth	08.026	170 mm	11 fori / holes	Ø 20	150 mm	grezzo / raw
Ø 22	liscio / smooth	08.027	170 mm	11 fori / holes	Ø 22	148 mm	grezzo / raw
Ø 25	liscio / smooth	08.028	180 mm	10 fori / holes	Ø 25	155 mm	grezzo / raw
Ø 30	liscio / smooth	08.029	200 mm	9 fori / holes	Ø 30	170 mm	grezzo / raw



■ 14x14	liscio / smooth	08.106	140 mm	14 fori / holes	□ 24x15 rettangolo / rectangular		grezzo / raw
■ 16x16	liscio / smooth	08.107	150 mm	13 fori / holes	□ 30x17 rettangolo / rectangular		grezzo / raw
■ 18x18	liscio / smooth	08.108	160 mm	12 fori / holes	□ 31x19 rettangolo / rectangular		grezzo / raw
■ 20x20	liscio / smooth	08.109	170 mm	11 fori / holes	□ 33x21 rettangolo / rectangular		grezzo / raw



Ø 14	corteccia / bark	08.130.01	125 mm	15 fori / holes	Ø 14	111 mm	grezzo / raw
Ø 14	corteccia / bark	08.109.01	140 mm	14 fori / holes	Ø 14	126 mm	grezzo / raw
Ø 16	corteccia / bark	08.130.02	125 mm	15 fori / holes	Ø 16	109 mm	grezzo / raw
Ø 16	corteccia / bark	08.109.02	150 mm	13 fori / holes	Ø 16	134 mm	grezzo / raw
Ø 18	corteccia / bark	08.130.03	128 mm	14 fori / holes	Ø 18	110 mm	grezzo / raw
Ø 18	corteccia / bark	08.109.03	160 mm	12 fori / holes	Ø 18	142 mm	grezzo / raw
Ø 20	corteccia / bark	08.109.04	170 mm	11 fori / holes	Ø 20	150 mm	grezzo / raw
Ø 22	corteccia / bark	08.109.05	170 mm	11 fori / holes	Ø 22	148 mm	grezzo / raw

lunghezza standard 2000 mm.
standard size 2000 mm.

- quadro / square
- ◇ foro quadro in obliquo / slanting square hole
- Ø tondo / round
- ∅ foro ovale / oval hole
- foro rettangolo / rectangular hole
- ES foro largo / larger hole

Riassunto barre forate in ordine di codice a pag. 270
Summary holed bars in order of code on pag. 270



sezione ferro <i>iron section</i>	tipo ferro <i>iron type</i>	codice <i>code</i>	interasse centre distance	nr. fori <i>nr. of holes</i>	tipo fori <i>kind of holes</i>	luce <i>hole to hole</i>	trattamento <i>finishing</i>
■ 12x12	martellato / hammered	08.110	120 mm	16 fori / holes	□ 12x12	108 mm	grezzo / raw
■ 14x14	martellato / hammered	08.111	140 mm	14 fori / holes	□ 14x14	126 mm	grezzo / raw
■ 16x16	martellato / hammered	08.112	150 mm	13 fori / holes	□ 16x16	134 mm	grezzo / raw
■ 18x18	martellato / hammered	08.113	160 mm	12 fori / holes	□ 18x18	142 mm	grezzo / raw
■ 20x20	martellato / hammered	08.114	170 mm	11 fori / holes	□ 20x20	150 mm	grezzo / raw



■ 14x14	corteccia / bark	08.114.01	140 mm	14 fori / holes	□ 14x14	126 mm	grezzo / raw
■ 16x16	corteccia / bark	08.114.02	150 mm	13 fori / holes	□ 16x16	134 mm	grezzo / raw



■ 14x14	corteccia / bark	08.114.10	140 mm	14 fori / holes	◇ 14x14	120 mm	grezzo / raw
■ 16x16	corteccia / bark	08.114.11	150 mm	13 fori / holes	◇ 16x16	127 mm	grezzo / raw



■ 14x14	martellato / hammered	08.114.20	140 mm	14 fori / holes	◇ 14x14 sullo spigolo / on the edge	120 mm	grezzo / raw
■ 16x16	martellato / hammered	08.114.21	150 mm	13 fori / holes	◇ 16x16 sullo spigolo / on the edge	127 mm	grezzo / raw



■ 12x12	in spigolo / edged	08.114.30	120 mm	16 fori / holes	□ 12x12	108 mm	grezzo / raw
■ 14x14	in spigolo / edged	08.114.31	140 mm	14 fori / holes	□ 14x14	126 mm	grezzo / raw
■ 16x16	in spigolo / edged	08.114.32	150 mm	13 fori / holes	□ 16x16	134 mm	grezzo / raw
■ 18x18	in spigolo / edged	08.114.33	160 mm	12 fori / holes	□ 18x18	142 mm	grezzo / raw

lunghezza standard 2000 mm.
standard size 2000 mm.

□	quadro / square
◇	foro quadro in obliquo / slanting square hole
∅	tondo / round
∅	foro ovale / oval hole
□	foro rettangolo / rectangular hole
ES	foro largo / larger hole

Riassunto barre forate in ordine di codice a pag. 270
Summary holed bars in order of code on pag. 270



BARRE FORATE SABBiate / SANDBLASTED HOLED BARS

sezione ferro <i>iron section</i>	tipo ferro <i>iron type</i>	codice <i>code</i>	interasse centre distance	nr. fori <i>nr. of holes</i>	tipo fori <i>kind of holes</i>	luce hole to hole	trattamento <i>finishing</i>
■ 12x12	liscio / smooth	08.133	120 mm	16 fori / holes	□ 12x12	108 mm	sabbiato / sandblasted
■ 14x14	liscio / smooth	08.168	125 mm	15 fori / holes	□ 14x14	111 mm	sabbiato / sandblasted
■ 14x14	liscio / smooth ES	08.168.01	125 mm	14 fori / holes	□ 14x14	111 mm.	sabbiato / sandblasted
■ 14x14	liscio / smooth	08.134	140 mm	14 fori / holes	□ 14x14	126 mm	sabbiato / sandblasted
■ 16x16	liscio / smooth	08.169	125 mm	15 fori / holes	□ 16x16	109 mm	sabbiato / sandblasted
■ 16x16	liscio / smooth	08.180	125 mm	15 fori / holes	□ 14x14	111 mm	sabbiato / sandblasted
■ 16x16	liscio / smooth ES	08.169.01	135 mm	14 fori / holes	□ 16x16	119 mm	sabbiato / sandblasted
■ 16x16	liscio / smooth	08.135	150 mm	13 fori / holes	□ 16x16	134 mm	sabbiato / sandblasted
■ 18x18	liscio / smooth	08.170	128 mm	14 fori / holes	□ 18x18	110 mm	sabbiato / sandblasted
■ 18x18	liscio / smooth	08.136	160 mm	12 fori / holes	□ 18x18	142 mm	sabbiato / sandblasted
■ 20x20	liscio / smooth	08.171	130 mm	13 fori / holes	□ 20x20	110 mm	sabbiato / sandblasted
■ 20x20	liscio / smooth	08.137	170 mm	11 fori / holes	□ 20x20	150 mm	sabbiato / sandblasted
■ 22x22	liscio / smooth	08.138	170 mm	11 fori / holes	□ 22x22	148 mm	sabbiato / sandblasted
■ 25x25	liscio / smooth	08.139	180 mm	10 fori / holes	□ 25x25	155 mm	sabbiato / sandblasted



BARRE FORATE SABBiate / SANDBLASTED HOLED BARS

■ 14x14	liscio / smooth	08.172	128 mm	14 fori / holes	◇ 14x14 sullo spigolo / on the edge	108 mm	sabbiato / sandblasted
■ 14x14	liscio / smooth	08.140	140 mm	14 fori / holes	◇ 14x14 sullo spigolo / on the edge	120 mm	sabbiato / sandblasted
■ 16x16	liscio / smooth	08.173	130 mm	14 fori / holes	◇ 16x16 sullo spigolo / on the edge	107 mm	sabbiato / sandblasted
■ 16x16	liscio / smooth	08.141	150 mm	13 fori / holes	◇ 16x16 sullo spigolo / on the edge	127 mm	sabbiato / sandblasted
■ 18x18	liscio / smooth	08.174	132 mm	14 fori / holes	◇ 18x18 sullo spigolo / on the edge	107 mm	sabbiato / sandblasted
■ 18x18	liscio / smooth	08.142	160 mm	12 fori / holes	◇ 18x18 sullo spigolo / on the edge	135 mm	sabbiato / sandblasted
■ 20x20	liscio / smooth	08.175	134 mm	13 fori / holes	◇ 20x20 sullo spigolo / on the edge	106 mm	sabbiato / sandblasted
■ 20x20	liscio / smooth	08.143	170 mm	11 fori / holes	◇ 20x20 sullo spigolo / on the edge	142 mm	sabbiato / sandblasted
■ 22x22	liscio / smooth	08.144	170 mm	11 fori / holes	◇ 22x22 sullo spigolo / on the edge	139 mm	sabbiato / sandblasted
■ 25x25	liscio / smooth	08.145	180 mm	10 fori / holes	◇ 25x25 sullo spigolo / on the edge	145 mm	sabbiato / sandblasted

lunghezza standard 2000 mm.
standard size 2000 mm.

- quadro / square
- ◇ foro quadro in obliquo / slanting square hole
- ∅ tondo / round
- ∅ foro ovale / oval hole
- foro rettangolo / rectangular hole
- ES** foro largo / larger hole

Riassunto barre forate in ordine di codice a pag. 270
Summary holed bars in order of code on pag. 270



BARRE FORATE SABBIAIE / SANDBLASTED HOLED BARS

sezione ferro iron section	tipo ferro iron type	codice code	interasse centre distance	nr. fori nr. of holes	tipo fori kind of holes	luce hole to hole	trattamento finishing
■ 14x14	liscio / smooth	08.176	128 mm	14 fori / holes	◇14x14	108 mm	sabbiato / sandblasted
■ 14x14	liscio / smooth ES	08.176.01	135 mm	14 fori / holes	◇14x14	115 mm	sabbiato / sandblasted
■ 14x14	liscio / smooth	08.146	140 mm	14 fori / holes	◇14x14	120 mm	sabbiato / sandblasted
■ 16x16	liscio / smooth ES	08.177.02	125 mm	15 fori / holes	◇16x16	102 mm	sabbiato / sandblasted
■ 16x16	liscio / smooth	08.177	130 mm	14 fori / holes	◇16x16	107 mm	sabbiato / sandblasted
■ 16x16	liscio / smooth ES	08.177.01	135 mm	14 fori / holes	◇16x16	112 mm	sabbiato / sandblasted
■ 16x16	liscio / smooth	08.147	150 mm	13 fori / holes	◇16x16	127 mm	sabbiato / sandblasted
■ 18x18	liscio / smooth	08.178	132 mm	14 fori / holes	◇18x18	107 mm	sabbiato / sandblasted
■ 18x18	liscio / smooth ES	08.178.01	135 mm	14 fori / holes	◇18x18	110 mm	sabbiato / sandblasted
■ 18x18	liscio / smooth	08.148	160 mm	12 fori / holes	◇18x18	135 mm	sabbiato / sandblasted
■ 20x20	liscio / smooth	08.179	135 mm	13 fori / holes	◇20x20	107 mm	sabbiato / sandblasted
■ 20x20	liscio / smooth	08.149	170 mm	11 fori / holes	◇20x20	142 mm	sabbiato / sandblasted
■ 22x22	liscio / smooth	08.150	170 mm	11 fori / holes	◇ 22x22	139 mm	sabbiato / sandblasted
■ 25x25	liscio / smooth	08.151	180 mm	10 fori / holes	◇25x25	145 mm	sabbiato / sandblasted



BARRE FORATE SABBIAIE / SANDBLASTED HOLED BARS

Ø 14	liscio / smooth	08.152	140 mm	14 fori / holes	∅ 14x26 mm ovale / oval		sabbiato / sandblasted
Ø 16	liscio / smooth	08.153	150 mm	13 fori / holes	∅ 16x28 mm ovale / oval		sabbiato / sandblasted
Ø 18	liscio / smooth	08.154	160 mm	12 fori / holes	∅ 18x30 mm ovale / oval		sabbiato / sandblasted
Ø 20	liscio / smooth	08.155	170 mm	11 fori / holes	∅ 20x33 mm ovale / oval		sabbiato / sandblasted



BARRE FORATE SABBIAIE / SANDBLASTED HOLED BARS

Ø 12	liscio / smooth	08.156	120 mm	16 fori / holes	Ø 12	108 mm	sabbiato / sandblasted
Ø 14	liscio / smooth	08.164	125 mm	15 fori / holes	Ø 14	111 mm	sabbiato / sandblasted
Ø 14	liscio / smooth	08.164.01	130 mm	14 fori / holes	Ø 14	116 mm	sabbiato / sandblasted
Ø 14	liscio / smooth	08.157	140 mm	14 fori / holes	Ø 14	126 mm	sabbiato / sandblasted
Ø 16	liscio / smooth	08.165	125 mm	15 fori / holes	Ø 16	109 mm	sabbiato / sandblasted
Ø 16	liscio / smooth	08.181	125 mm	15 fori / holes	Ø 14	111 mm	sabbiato / sandblasted
Ø 16	liscio / smooth	08.158	150 mm	13 fori / holes	Ø 16	134 mm	sabbiato / sandblasted
Ø 16	liscio / smooth	08.165.01	160 mm	12 fori / holes	Ø 16	144 mm	sabbiato / sandblasted
Ø 18	liscio / smooth	08.166	128 mm	14 fori / holes	Ø 18	110 mm	sabbiato / sandblasted
Ø 18	liscio / smooth	08.159	160 mm	12 fori / holes	Ø 18	142 mm	sabbiato / sandblasted
Ø 20	liscio / smooth	08.167	130 mm	13 fori / holes	Ø 20	110 mm	sabbiato / sandblasted
Ø 20	liscio / smooth	08.160	170 mm	11 fori / holes	Ø 20	150 mm	sabbiato / sandblasted
Ø 22	liscio / smooth	08.161	170 mm	11 fori / holes	Ø 22	148 mm	sabbiato / sandblasted
Ø 25	liscio / smooth	08.162	180 mm	10 fori / holes	Ø 25	155 mm	sabbiato / sandblasted
Ø 30	liscio / smooth	08.163	200 mm	9 fori / holes	Ø 30	170 mm	sabbiato / sandblasted

BARRE FORATE HOLED BARS

Palline Grandi / Large Balls

INTERASSE / CENTRE DISTANCE 135 mm.

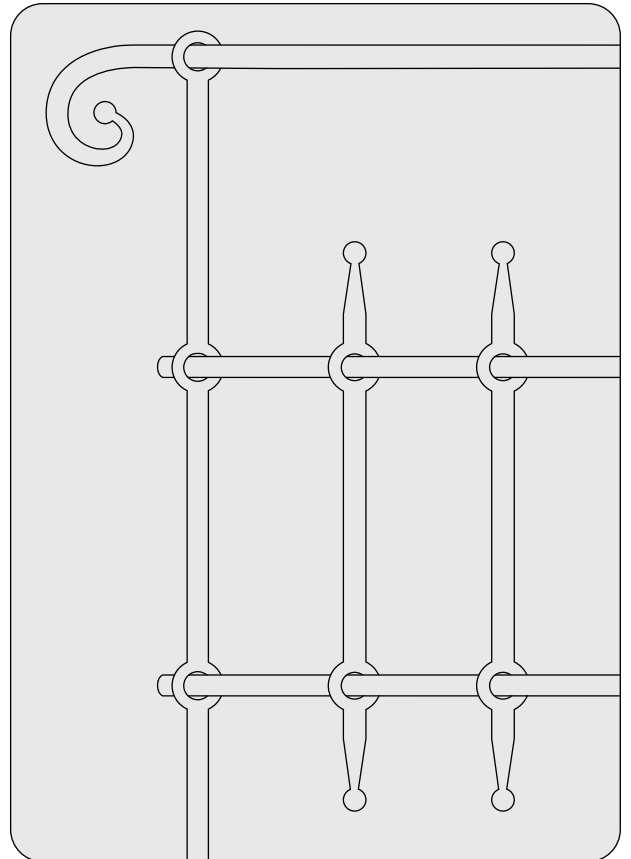
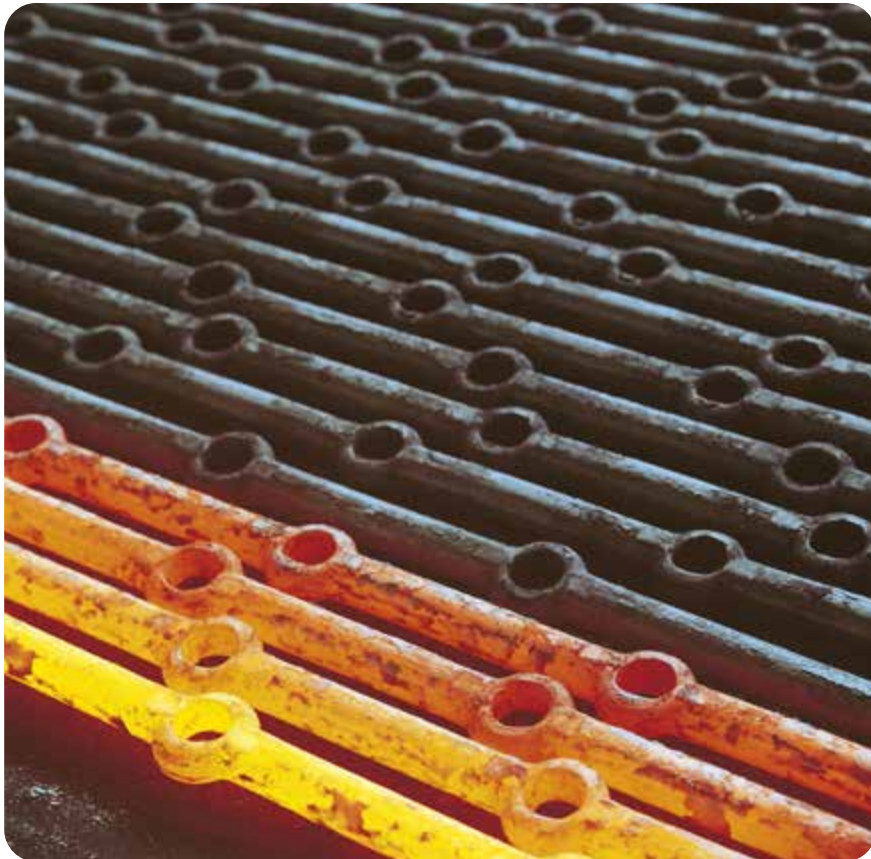
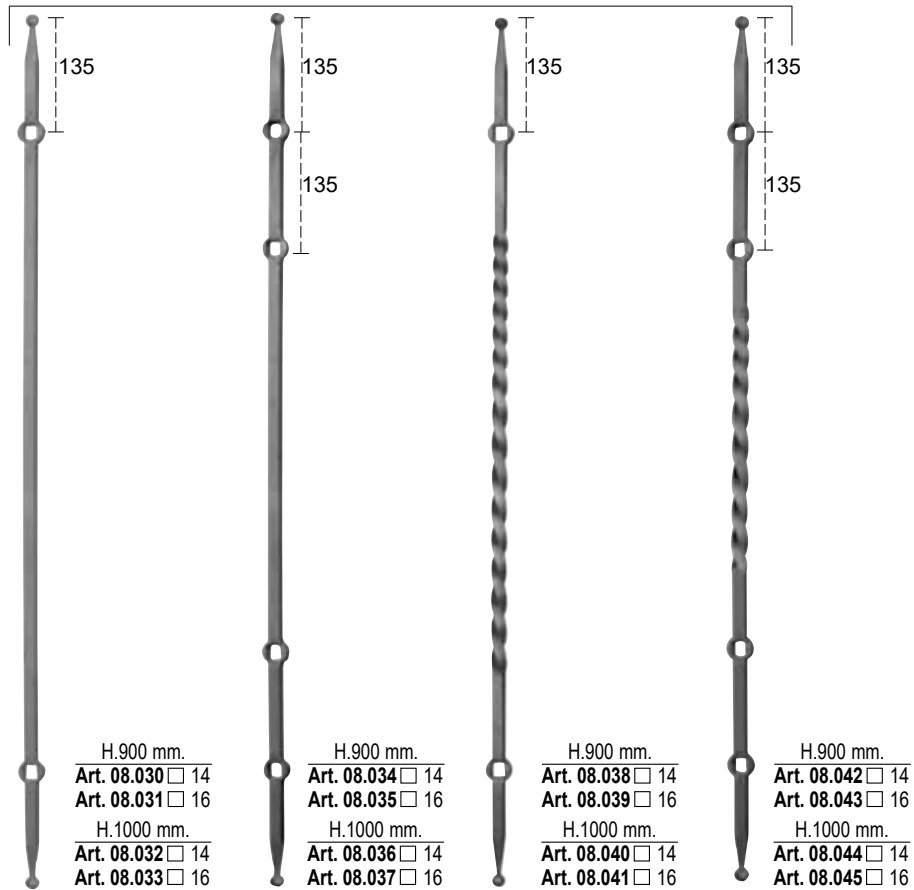

ZF ARTICOLI ZINCATI A FREDDO
COLD GALVANIZED ARTICLES

Per le barre forate Zincate a Freddo andare a pag. 270 del Catalogo.
See our Cold Galvanized holed bars at pag. 270 of the Catalogue.

Tutte le parti di questo catalogo - foto comprese - sono di proprietà Euro-Fer. La riproduzione, anche parziale, è vietata in ogni forma e con ogni mezzo. / Every part of this catalogue - photos included - is Euro-Fer's property. All forms of copying are strictly prohibited.

FORO TONDO / ROUND HOLE

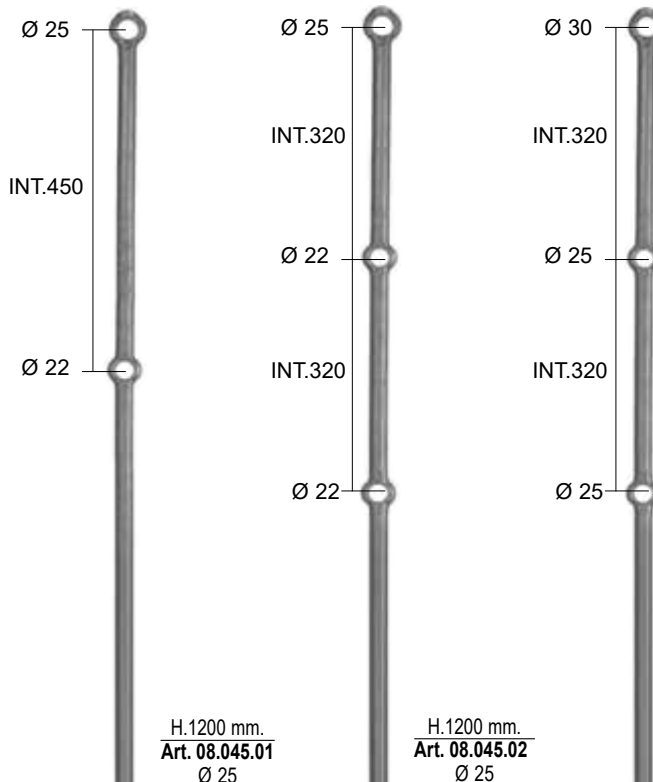

H. 1200 mm.
Art. 08.045.01
Ø 25

H. 1200 mm.
Art. 08.045.02
Ø 25

H. 1200 mm.
Art. 08.045.03
Ø 30

FORO OVALE / OVAL HOLE

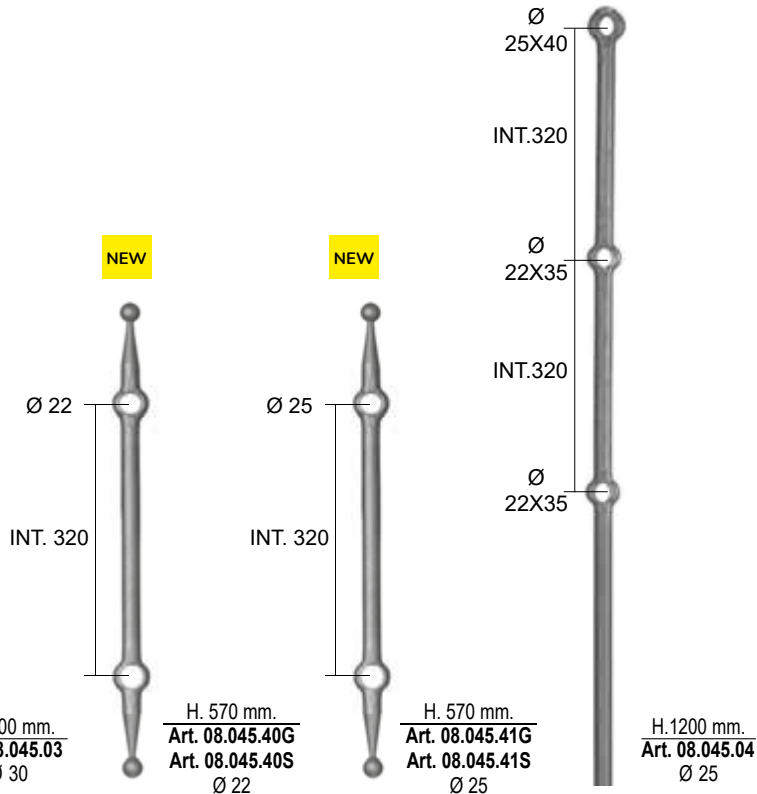

H. 570 mm.
Art. 08.045.40G
Art. 08.045.40S
Ø 22

H. 570 mm.
Art. 08.045.41G
Art. 08.045.41S
Ø 25

H. 1200 mm.
Art. 08.045.04
Ø 25

G: grezzo / raw
S: sabbiato / sandblasted

NEW

NEW

FORO OVALE
OVAL HOLE

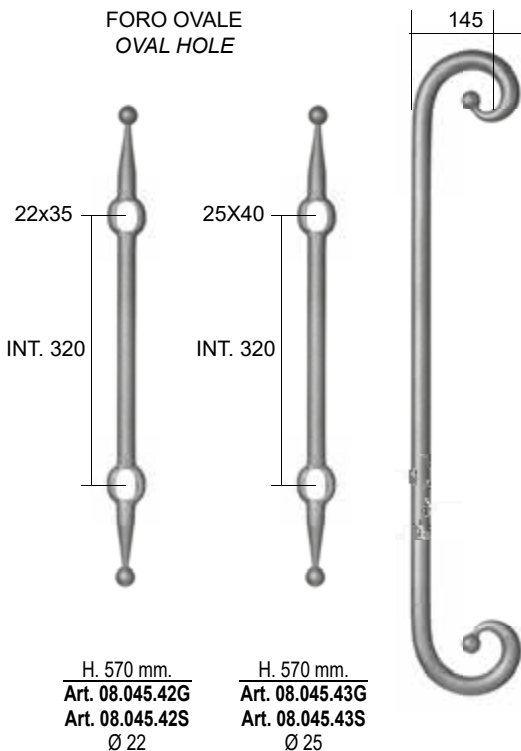

H. 570 mm.
Art. 08.045.42G
Art. 08.045.42S
Ø 22

H. 570 mm.
Art. 08.045.43G
Art. 08.045.43S
Ø 25

H. 740 X L. 120 mm.
Art. 08.045.45G
Art. 08.045.45S
Ø 20

H. 740 X L. 125 mm.
Art. 08.045.46G
Art. 08.045.46S
Ø 22

H. 740 X L. 130 mm.
Art. 08.045.47G
Art. 08.045.47S
Ø 25

H. 740 X L. 145 mm.
Art. 08.045.48G
Art. 08.045.48S
Ø 30

FORO TONDO
ROUND HOLE

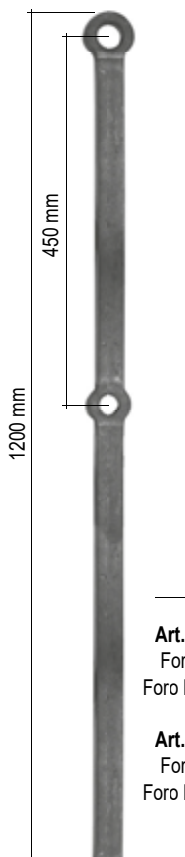

Liscio / Smooth
H. 1200 mm
Art. 08.045.30 □ 30 X 30 mm
Foro alto / Top hole Ø 30 mm
Foro basso / Down hole Ø 25 mm

Art. 08.045.32 □ 30 X 30 mm
Foro alto / Top hole Ø 25 mm
Foro basso / Down hole Ø 22 mm

FORO QUADRO IN OBLIQUO
SLATING SQUARE HOLE

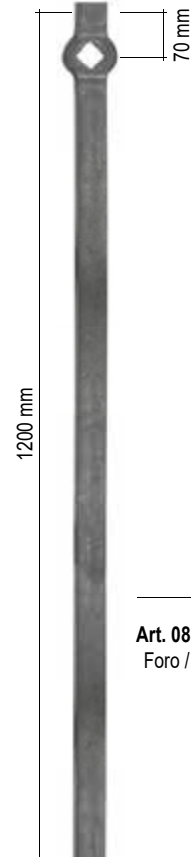

Liscio / Smooth
H. 1200 mm
Art. 08.045.50 □ 30 X 30 mm
Foro / Hole ◇ 30 X 30 mm

**BARRE FORATE
HOLED BARS**

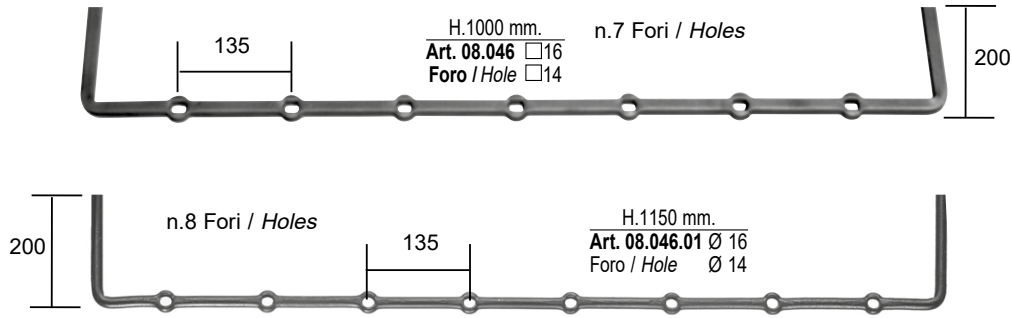

INT. standard: 125 mm. - n. Fori 15

MISURE STANDARD 2000 mm. / 2000 mm. STANDARD SIZE

INT. = INTERASSE / CENTRE DISTANCE

LUCE = DISTANCE BETWEEN HOLES

FORO = HOLE

**FORO QUADRO IN OBLIQUO
SLANTING SQUARE HOLE**

INT. 125
15 Fori per barra
Holes per bar

H.2000 mm. Foro \diamond 12
Art. 08.047 \neq 30 X 8
Art. 08.048 \neq 30 X 10
Art. 08.049 \neq 35 X 8
Art. 08.050 \neq 35 X 10
Art. 08.051 \neq 40 X 8
Art. 08.052 \neq 40 X 10

H.2000 mm. Foro \diamond 14
Art. 08.053 \neq 30 X 8
Art. 08.054 \neq 30 X 10
Art. 08.055 \neq 35 X 8
Art. 08.056 \neq 35 X 10
Art. 08.057 \neq 40 X 8
Art. 08.058 \neq 40 X 10

H.2000 mm. Foro \diamond 16
Art. 08.058.01 \neq 30 X 8
Art. 08.058.02 \neq 30 X 10
Art. 08.058.03 \neq 35 X 8
Art. 08.058.04 \neq 35 X 10
Art. 08.058.05 \neq 40 X 8
Art. 08.058.06 \neq 40 X 10

**FORO QUADRO IN OBLIQUO
SLANTING SQUARE HOLE**

INT. 149

INT. 149 mm.
Luce 128 mm.
n. Fori 12

H.2000 mm. Foro \diamond 14
Art. 08.058.07 \neq 30 X 8
Art. 08.058.08 \neq 30 X 10

**FORO QUADRO IN OBLIQUO
SLANTING SQUARE HOLE**

INT. 74,5

INT. 74,5 mm.
Luce 53,5 mm.
n. Fori 26

H.2000 mm. Foro \diamond 14
Art. 08.058.09 \neq 30 X 8
Art. 08.058.10 \neq 30 X 10

**FORO QUADRO
SQUARE HOLE**

INT. 125
15 Fori per barra
Holes per bar

H.2000 mm. Foro \square 12
Art. 08.059 \neq 30 X 8
Art. 08.060 \neq 30 X 10
Art. 08.061 \neq 35 X 8
Art. 08.062 \neq 35 X 10
Art. 08.063 \neq 40 X 8
Art. 08.064 \neq 40 X 10

H.2000 mm. Foro \square 14
Art. 08.065 \neq 30 X 8
Art. 08.066 \neq 30 X 10
Art. 08.067 \neq 35 X 8
Art. 08.068 \neq 35 X 10
Art. 08.069 \neq 40 X 8
Art. 08.070 \neq 40 X 10

H.2000 mm. Foro \square 16
Art. 08.070.01 \neq 30 X 8
Art. 08.070.02 \neq 30 X 10
Art. 08.070.03 \neq 35 X 8
Art. 08.070.04 \neq 35 X 10
Art. 08.070.05 \neq 40 X 8
Art. 08.070.06 \neq 40 X 10

INT. 112
17 Fori per barra
17 Holes per bar

H. 2000 Foro / Hole \diamond 12
Art. 08.046.100 \neq 30 X 8 mm
Art. 08.046.101 \neq 40 X 8 mm

H. 2000 Foro / Hole \diamond 14
Art. 08.046.106 \neq 30 X 8 mm
Art. 08.046.107 \neq 40 X 8 mm

H. 2000 Foro / Hole \diamond 16
Art. 08.046.112 \neq 30 X 8 mm
Art. 08.046.113 \neq 40 X 8 mm

INT. 112
17 Fori per barra
17 Holes per bar

H. 2000 Foro / Hole \square 12
Art. 08.058.100 \neq 30 X 8 mm
Art. 08.058.101 \neq 40 X 8 mm

H. 2000 Foro / Hole \square 14
Art. 08.058.106 \neq 30 X 8 mm
Art. 08.058.107 \neq 40 X 8 mm

H. 2000 Foro / Hole \square 16
Art. 08.058.112 \neq 30 X 8 mm
Art. 08.058.113 \neq 40 X 8 mm

INT. 112
17 Fori per barra
17 Holes per bar

H. 2000 Foro / Hole \square 12
Art. 08.070.100 \neq 30 X 8 mm
Art. 08.070.101 \neq 40 X 8 mm

H. 2000 Foro / Hole \square 14
Art. 08.070.106 \neq 30 X 8 mm
Art. 08.070.107 \neq 40 X 8 mm

H. 2000 Foro / Hole \square 16
Art. 08.070.112 \neq 30 X 8 mm
Art. 08.070.113 \neq 40 X 8 mm

Le barre forate possono essere prodotte anche da 3000 mm. / Our flat punched bars are also available at 3 meter length.

Tutte le parti di questo catalogo - foto comprese - sono di proprietà Euro-Fer. La riproduzione, anche parziale, è vietata in ogni forma e con ogni mezzo. / Every part of this catalogue - photos included - is Euro-Fer's property. All forms of copying are strictly prohibited.

INT. standard: 125 mm. - n. Fori 15

MISURE STANDARD 2000 mm. / 2000 mm. STANDARD SIZE

INT. = INTERASSE / CENTRE DISTANCE

LUCE = DISTANCE BETWEEN HOLES

FORO = HOLE



FORO QUADRO
SQUARE HOLE



FORO QUADRO
SQUARE HOLE



FORO TONDO
ROUND HOLE

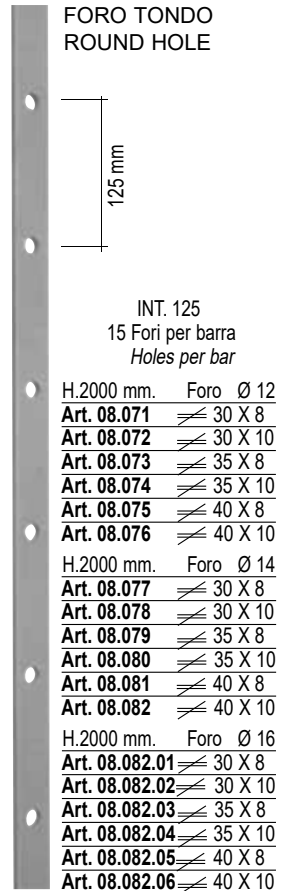

Piatto Martellato 4 Lati / *Hammered Flat - 4 Sides*

FORO QUADRO IN OBLIQUO
SLANTING SQUARE HOLE

INT. 125
15 Fori per barra / Holes per bar

H.2000 mm. Foro ◊ 12
Art. 08.082.20 ≡ 30 X 8
Art. 08.082.21 ≡ 30 X 10
Art. 08.082.22 ≡ 35 X 8
Art. 08.082.23 ≡ 35 X 10
Art. 08.082.24 ≡ 40 X 8
Art. 08.082.25 ≡ 40 X 10

H.2000 mm. Foro ◊ 14
Art. 08.082.26 ≡ 30 X 8
Art. 08.082.27 ≡ 30 X 10
Art. 08.082.28 ≡ 35 X 8
Art. 08.082.29 ≡ 35 X 10
Art. 08.082.30 ≡ 40 X 8
Art. 08.082.31 ≡ 40 X 10

H.2000 mm. Foro ◊ 16
Art. 08.082.32 ≡ 30 X 8
Art. 08.082.33 ≡ 30 X 10
Art. 08.082.34 ≡ 35 X 8
Art. 08.082.35 ≡ 35 X 10
Art. 08.082.36 ≡ 40 X 8
Art. 08.082.37 ≡ 40 X 10

FORO QUADRO
SQUARE HOLE

INT. 125
15 Fori per barra / Holes per bar

H.2000 mm. □ 12 X 12
Art. 08.082.38 ≡ 30 X 8
Art. 08.082.39 ≡ 30 X 10
Art. 08.082.40 ≡ 35 X 8
Art. 08.082.41 ≡ 35 X 10
Art. 08.082.42 ≡ 40 X 8
Art. 08.082.43 ≡ 40 X 10

H.2000 mm. □ 14 X 14
Art. 08.082.44 ≡ 30 X 8
Art. 08.082.45 ≡ 30 X 10
Art. 08.082.46 ≡ 35 X 8
Art. 08.082.47 ≡ 35 X 10
Art. 08.082.48 ≡ 40 X 8
Art. 08.082.49 ≡ 40 X 10

H.2000 mm. □ 16 X 16
Art. 08.082.50 ≡ 30 X 8
Art. 08.082.51 ≡ 30 X 10
Art. 08.082.52 ≡ 35 X 8
Art. 08.082.53 ≡ 35 X 10
Art. 08.082.54 ≡ 40 X 8
Art. 08.082.55 ≡ 40 X 10

FORO TONDO
ROUND HOLE

INT. 125
15 Fori per barra / Holes per bar

H.2000 mm. Ø 12
Art. 08.082.56 ≡ 30 X 8
Art. 08.082.57 ≡ 30 X 10
Art. 08.082.58 ≡ 35 X 8
Art. 08.082.59 ≡ 35 X 10
Art. 08.082.60 ≡ 40 X 8
Art. 08.082.61 ≡ 40 X 10

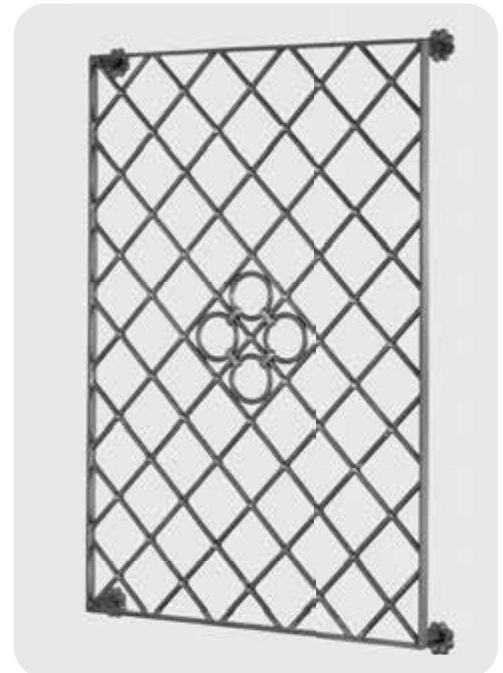

H.2000 mm. Ø 14
Art. 08.082.62 ≡ 30 X 8
Art. 08.082.63 ≡ 30 X 10
Art. 08.082.64 ≡ 35 X 8
Art. 08.082.65 ≡ 35 X 10
Art. 08.082.66 ≡ 40 X 8
Art. 08.082.67 ≡ 40 X 10

H.2000 mm. Ø 16
Art. 08.082.68 ≡ 30 X 8
Art. 08.082.69 ≡ 30 X 10
Art. 08.082.70 ≡ 35 X 8
Art. 08.082.71 ≡ 35 X 10
Art. 08.082.72 ≡ 40 X 8
Art. 08.082.73 ≡ 40 X 10





Le barre forate possono essere prodotte anche da 3000 mm. / Our flat punched bars are also available at 3 meter length.

Tutte le parti di questo catalogo - foto comprese - sono di proprietà Euro-Fer. La riproduzione, anche parziale, è vietata in ogni forma e con ogni mezzo. / Every part of this catalogue - photos included - is Euro-Fer's property. All forms of copying are strictly prohibited.

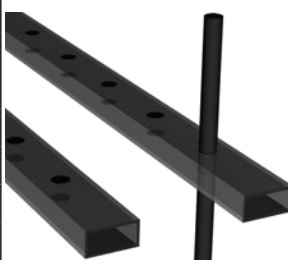
Sezione tubolare <i>Tubular section</i>	Lunghezza <i>Lengths</i>	Tipo di foro <i>Type of hole</i>	Nr. fori <i>Nr. holes</i>	Interasse <i>centre distance</i>	Sezione fori <i>Holes section</i>	Codice <i>Code</i>	
 <p style="text-align: center;">30 x 20 x 2 mm <i>Larghezza x Altezza x Spessore Width x Height x Thickness</i></p>	2000 mm	passante	15 fori	125 mm	∅ 12	08.082.100	
					∅ 14	08.082.101	
					■ 12	08.082.102	
		3000 mm	passante	23 fori	125 mm	∅ 12	08.082.105
						∅ 14	08.082.106
						■ 12	08.082.107
	6000 mm	passante	47 fori	125 mm	∅ 12	08.082.110	
					∅ 14	08.082.111	
					■ 12	08.082.112	
		2000 mm	in battuta	15 fori	125 mm	∅ 12	08.082.115
						∅ 14	08.082.117
						■ 12	08.082.116
	3000 mm	in battuta	23 fori	125 mm	∅ 12	08.082.118	
					∅ 14	08.082.120	
					■ 12	08.082.119	
	6000 mm	in battuta	47 fori	125 mm	∅ 12	08.082.121	
					∅ 14	08.082.123	
					■ 12	08.082.122	
 <p style="text-align: center;">40 x 20 x 2 mm <i>Larghezza x Altezza x Spessore Width x Height x Thickness</i></p>		2000 mm	passante	15 fori	125 mm	∅ 12	08.082.148
						∅ 14	08.082.149
						∅ 16	08.082.150
	∅ 18					08.082.151	
	∅ 20					08.082.152	
	■ 12					08.082.154	
	■ 14					08.082.155	
	■ 16					08.082.156	
	■ 18					08.082.157	
	■ 20	08.082.158					
	3000 mm	passante	23 fori	125 mm	∅ 12	08.082.163	
					∅ 14	08.082.164	
					∅ 16	08.082.165	
					∅ 18	08.082.166	
					∅ 20	08.082.167	
					■ 12	08.082.169	
					■ 14	08.082.170	
					■ 16	08.082.171	
■ 18					08.082.172		
■ 20	08.082.173						
6000 mm	passante	47 fori	125 mm	∅ 12	08.082.178		
				∅ 14	08.082.179		
				∅ 16	08.082.180		
				∅ 18	08.082.181		
				∅ 20	08.082.182		
				■ 12	08.082.184		
				■ 14	08.082.185		
				■ 16	08.082.186		
				■ 18	08.082.187		
■ 20	08.082.188						

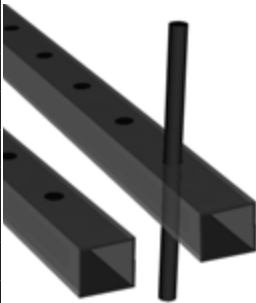
Sezione tubolare <i>Tubular section</i>	Lunghezza <i>Lengths</i>	Tipo di foro <i>Type of hole</i>	Nr. fori <i>Nr. holes</i>	Interasse <i>centre distance</i>	Sezione fori <i>Holes section</i>	Codice <i>Code</i>
 <p>40 x 20 x 2 mm <i>Larghezza x Altezza x Spessore Width x Height x Thickness</i></p>	2000 mm	in battuta	15 fori	125 mm	∅ 12	08.082.193
					∅ 14	08.082.194
					∅ 16	08.082.195
					∅ 18	08.082.196
					■ 12	08.082.199
					■ 14	08.082.200
					■ 16	08.082.201
					■ 18	08.082.202
	3000 mm	in battuta	23 fori	125 mm	∅ 12	08.082.207
					∅ 14	08.082.208
					∅ 16	08.082.209
					∅ 18	08.082.210
					■ 12	08.082.213
					■ 14	08.082.214
	6000 mm	in battuta	47 fori	125 mm	∅ 12	08.082.221
					∅ 14	08.082.222
					∅ 16	08.082.223
					∅ 18	08.082.224
■ 12					08.082.227	
■ 14					08.082.228	
■ 16					08.082.229	
■ 18					08.082.230	
 <p>50 x 25 x 2 mm <i>Larghezza x Altezza x Spessore Width x Height x Thickness</i></p>	2000 mm	passante	15 fori	125 mm	∅ 14	08.082.323
					∅ 16	08.082.324
					∅ 18	08.082.325
					∅ 20	08.082.326
					■ 14	08.082.330
					■ 16	08.082.331
	3000 mm	passante	23 fori	125 mm	∅ 18	08.082.332
					■ 18	08.082.332
					■ 20	08.082.333
					∅ 14	08.082.340
					∅ 16	08.082.341
					∅ 18	08.082.342
	6000 mm	passante	47 fori	125 mm	∅ 20	08.082.343
					■ 14	08.082.347
					■ 16	08.082.348
					■ 18	08.082.349
					■ 20	08.082.350
					∅ 14	08.082.357
∅ 16					08.082.358	
∅ 18					08.082.359	
6000 mm	passante	47 fori	125 mm	∅ 20	08.082.360	
				■ 14	08.082.364	
				■ 16	08.082.365	
				■ 18	08.082.366	
					■ 20	08.082.367

Sezione tubolare <i>Tubular section</i>	Lunghezza <i>Lengths</i>	Tipo di foro <i>Type of hole</i>	Nr. fori <i>Nr. holes</i>	Interasse <i>centre distance</i>	Sezione fori <i>Holes section</i>	Codice <i>Code</i>
 <p style="text-align: center;">50 x 25 x 2 mm <i>Larghezza x Altezza x Spessore</i> <i>Width x Height x Thickness</i></p>	2000 mm	in battuta	15 fori	125 mm	∅ 14	08.082.374
					∅ 16	08.082.375
					∅ 18	08.082.376
					∅ 20	08.082.377
					■ 14	08.082.381
					■ 16	08.082.382
					■ 18	08.082.383
	3000 mm	in battuta	23 fori	125 mm	∅ 14	08.082.390
					∅ 16	08.082.391
					∅ 18	08.082.392
					∅ 20	08.082.393
					■ 14	08.082.397
					■ 16	08.082.398
					■ 18	08.082.399
	6000 mm	in battuta	47 fori	125 mm	∅ 14	08.082.406
					∅ 16	08.082.407
					∅ 18	08.082.408
					∅ 20	08.082.409
					■ 14	08.082.413
					■ 16	08.082.414
					■ 18	08.082.415
 <p style="text-align: center;">40 x 40 x 2 mm <i>Larghezza x Altezza x Spessore</i> <i>Width x Height x Thickness</i></p>	2000 mm	passante	15 fori	125 mm	∅ 12	08.082.510
					∅ 14	08.082.511
					∅ 16	08.082.514
					■ 12	08.082.512
					■ 14	08.082.513
	3000 mm	passante	23 fori	125 mm	∅ 12	08.082.520
					∅ 14	08.082.521
					∅ 16	08.082.524
					■ 12	08.082.522
					■ 14	08.082.523
	6000 mm	passante	47 fori	125 mm	∅ 12	08.082.530
					∅ 14	08.082.531
					∅ 16	08.082.534
					■ 12	08.082.532
					■ 14	08.082.533
					■ 16	08.082.535

Sezione tubolare <i>Tubular section</i>	Lunghezza <i>Lengths</i>	Tipo di foro <i>Type of hole</i>	Nr. fori <i>Nr. holes</i>	Interasse <i>centre distance</i>	Sezione fori <i>Holes section</i>	Codice <i>Code</i>
 <p>NEW</p> <p>40 x 40 x 2 mm <i>Larghezza x Altezza x Spessore Width x Height x Thickness</i></p>	2000 mm	in battuta	15 fori	125 mm	∅ 12	08.082.610
					∅ 14	08.082.611
					∅ 16	08.082.614
					■ 12	08.082.612
					■ 14	08.082.613
	3000 mm	in battuta	23 fori	125 mm	∅ 12	08.082.620
					∅ 14	08.082.621
					∅ 16	08.082.624
					■ 12	08.082.622
					■ 14	08.082.623
	6000 mm	in battuta	47 fori	125 mm	∅ 12	08.082.630
					∅ 14	08.082.631
					∅ 16	08.082.634
					■ 12	08.082.632
					■ 14	08.082.633
					■ 16	08.082.635

Su richiesta è possibile realizzare tubi forati di diverse lunghezze e con diverse misure di interasse
Customized sizes and dimensions available on demand

Per realizzare un tubo forato a misura dovete indicare /
For customized items please indicate:

Tipo di tubo / Type of tube

- 30x20 x 2mm Tubo Liscio / *Plain*
- 40x20 x 2mm Tubo Liscio / *Plain*
- 40x40 x 3mm Tubo Liscio / *Plain*
- 50x25 x 2mm Tubo Liscio / *Plain*

▭ Lunghezza tubo / *Tube length*

▭ Int. A / *Int. A*

■ fori passanti / *fully drilled holes*

■ fori in battuta / *part drilled holes*

▭ Numero dei fori / *Number of holes*

Tipo di fori e dimensioni / Kind and sizes of hole

■ □ ▭ mm

■ ∅ ▭ mm

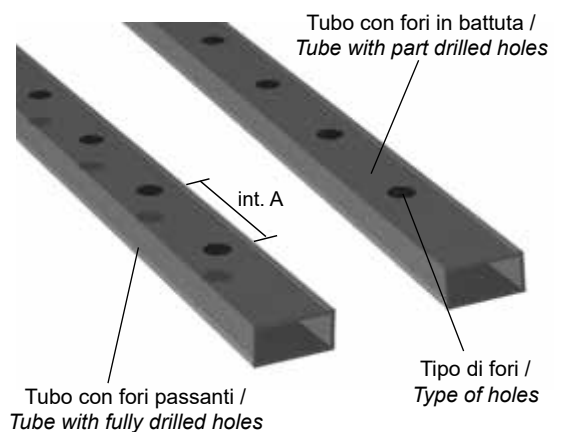

Cliente

Data

Timbro e Firma

Note

Sezione tubolare <i>Tubular section</i>		Lunghezza <i>Lengths</i>	Nr. fori <i>Nr. holes</i>	Interasse <i>centre distance</i>	Sezione fori <i>Holes section</i>	Codice <i>Code</i>
 <p style="text-align: center;">NEW</p> <p style="text-align: center;">30 x 20 x 2 mm Larghezza x Altezza x Spessore <i>Width x Height x Thickness</i></p>	2000 mm	15 fori	125 mm	∅ 12	08.082.1000	
				∅ 14	08.082.1001	
				∅ 16	08.082.1002	
				■ 12	08.082.1004	
				■ 14	08.082.1005	
	3000 mm	23 fori	125 mm	■ 16	08.082.1006	
				∅ 12	08.082.1008	
				∅ 14	08.082.1009	
				∅ 16	08.082.1010	
				■ 12	08.082.1012	
	6000 mm	47 fori	125 mm	■ 14	08.082.1013	
				■ 16	08.082.1014	
				∅ 12	08.082.1016	
				∅ 14	08.082.1017	
				∅ 16	08.082.1018	
 <p style="text-align: center;">NEW</p> <p style="text-align: center;">40 x 20 x 2 mm Larghezza x Altezza x Spessore <i>Width x Height x Thickness</i></p>	2000 mm	15 fori	125 mm	■ 12	08.082.1020	
				■ 14	08.082.1021	
				■ 16	08.082.1022	
				∅ 14	08.082.1040	
				∅ 16	08.082.1041	
	3000 mm	23 fori	125 mm	∅ 18	08.082.1042	
				■ 14	08.082.1045	
				■ 16	08.082.1046	
				■ 18	08.082.1047	
				∅ 14	08.082.1050	
	6000 mm	47 fori	125 mm	∅ 16	08.082.1051	
				∅ 18	08.082.1052	
				■ 14	08.082.1055	
				■ 16	08.082.1056	
				■ 18	08.082.1057	
6000 mm	47 fori	125 mm	■ 18	08.082.1067		
			∅ 14	08.082.1060		
			∅ 16	08.082.1061		
			∅ 18	08.082.1062		
			■ 14	08.082.1065		
■ 16	08.082.1066					

Sezione tubolare <i>Tubular section</i>	Lunghezza <i>Lengths</i>	Nr. fori <i>Nr. holes</i>	Interasse <i>centre distance</i>	Sezione fori <i>Holes section</i>	Codice <i>Code</i>
 <p>NEW</p> <p>50 x 25 x 2 mm Larghezza x Altezza x Spessore <i>Width x Height x Thickness</i></p>	2000 mm	15 fori	125 mm	∅ 16	08.082.1100
				∅ 18	08.082.1101
				∅ 20	08.082.1102
				■ 16	08.082.1105
				■ 18	08.082.1106
	3000 mm	23 fori	125 mm	■ 20	08.082.1107
				∅ 16	08.082.1110
				∅ 18	08.082.1111
				∅ 20	08.082.1112
				■ 16	08.082.1115
	6000 mm	47 fori	125 mm	■ 18	08.082.1116
				■ 20	08.082.1117
				∅ 16	08.082.1120
				∅ 18	08.082.1121
				∅ 20	08.082.1122
			■ 16	08.082.1125	
			■ 18	08.082.1126	
			■ 20	08.082.1127	

BARRE FORATE HOLED BARS

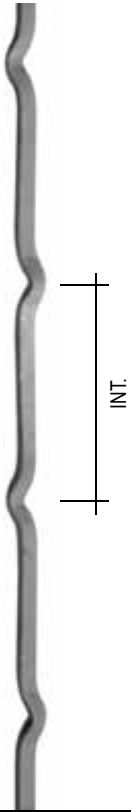

Piegatura alternata sullo spigolo <i>Bending on the corner</i>				NEW	Piegatura alternata sul piano <i>Bending on the plane</i>			
Lunghezza <i>Lengths</i>	Sezione fori <i>Holes section</i>	Interasse <i>centre distance</i>	Codice <i>Code</i>	Lunghezza <i>Lengths</i>	Sezione fori <i>Holes section</i>	Interasse <i>centre distance</i>	Codice <i>Code</i>	
6000 m	■ 12 x 12	120 mm	Art. 08.083	6000 m	■ 12 x 12	120 mm	Art. 08.083.01	
		140 mm	Art. 08.084			140 mm	Art. 08.084.01	
		160 mm	Art. 08.085			160 mm	Art. 08.085.01	
		180 mm	Art. 08.086			180 mm	Art. 08.086.01	
		200 mm	Art. 08.087			200 mm	Art. 08.087.01	
		300 mm	Art. 08.088			300 mm	Art. 08.088.01	
6000 m	■ 14 x 14	120 mm	Art. 08.089	6000 m	■ 14 x 14	120 mm	Art. 08.089.01	
		140 mm	Art. 08.090			140 mm	Art. 08.090.01	
		160 mm	Art. 08.091			160 mm	Art. 08.091.01	
		180 mm	Art. 08.092			180 mm	Art. 08.092.01	
		200 mm	Art. 08.093			200 mm	Art. 08.093.01	
		300 mm	Art. 08.094			300 mm	Art. 08.094.01	

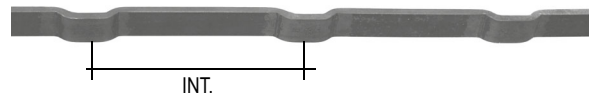

H.2000 mm. \neq 20x4
 Art. 08.094.50 INT. 120
 Art. 08.094.51 INT. 160

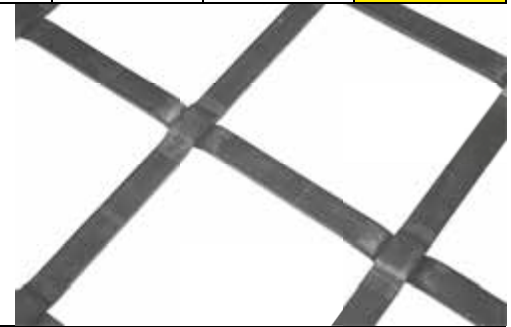

SALISBURGHESI

LE BARRE "SALISBURGHESI" SONO FORNITE SINGOLARMENTE: SONO ACCOPPIATE SOLO A TITOLO DIMOSTRATIVO.
 THE "SALISBURGHESI" BARS ARE SUPPLIED SEPARATELY: THEY ARE ONLY IN PAIRS FOR DEMONSTRATION PURPOSES.

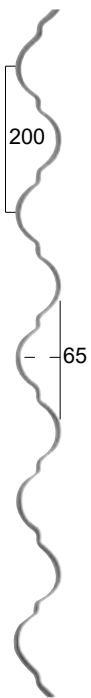

H.2500 X L.65 mm.
 Art. 08.095
 \neq 16 X 5



H.2500 X L.70 mm.
 Art. 08.096 \neq 16 X 8
 Rigato / Striped

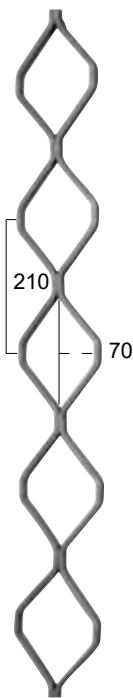

H.2500 X L.70 mm.
 Art. 08.097 \neq 16 X 8
 Rigato / Striped



H.2500 X L.65 mm.
 Art. 08.098 \neq 16 X 8
 Art. 08.099 \varnothing 10
 Art. 08.100 \varnothing 12

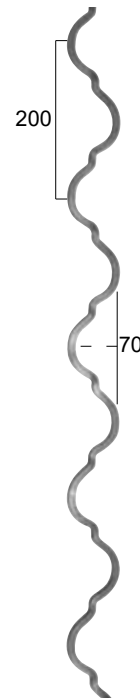

H.2500 X L.70 mm.
 Art. 08.101 □ 8
 Art. 08.102 □ 10
 Art. 08.103 □ 12

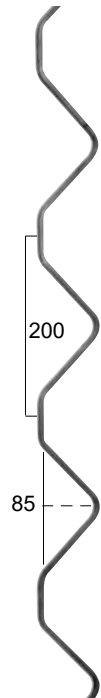

H.2500 X L.85 mm.
 Art. 08.104
 □ 8 X 8



Spazio per inserimento □ 14 mm.
Space for square insert □ 14 mm.

FORO
OBLIQUO
SLANTING
HOLE

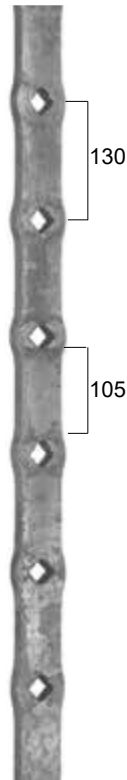

Martellato / *Hammered*
H.2000 mm. □ 14 X 14
Art. 08.105 INT.125 mm.
N. Nocchie / *Knobs* 16

Liscio / *Smooth*
H.2000 mm. □ 14 X 14
Art. 08.105.01 INT.125 mm.
N. Nocchie / *Knobs* 16

H.2000 mm. ≇ 50 X 20
Art. 08.105.02 INT.130 mm.
Luce 105 mm.
N. Fori / *Holes* 14 ◊ 22

PIATTI CON RIBATTINI STAMPATI
PLAT BARS WITH FORGED RIVETS



PIATTO LISCIO
SMOOTH FLAT

H.2000 mm.
Art. 08.182
≇ 30 X 6
INT. 125 mm.

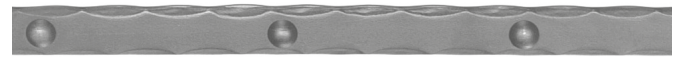

PIATTO MARTELLATO
HAMMERED FLAT

H.2000 mm.
Art. 08.183
≇ 30 X 6
INT. 125 mm.



PIATTO SAGOMATO
MODELLED FLAT

H.2000 mm.
Art. 08.184
≇ 30 X 8
INT. 132 mm.

H.2000 mm.
Art. 08.184.02
≇ 40 X 8
INT. 132 mm.

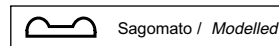

H.3000 mm.
Art. 08.184.01
≇ 30 X 8
INT. 132 mm.

H.3000 mm.
Art. 08.184.03
≇ 40 X 8
INT. 132 mm.



Liscio / *Smooth*
Foro ad asola / *Buttonhole*
H.2000 mm ≇ 40 x 8 mm

Art. 08.199 fori / hole □ 12 mm - int. 130 mm - n°14 fori / holes
Art. 08.199.01 fori / hole □ 12 mm - int. 135 mm - n°14 fori / holes
Art. 08.199.02 fori / hole □ 14 mm - int. 130 mm - n°14 fori / holes
Art. 08.199.03 fori / hole □ 14 mm - int. 135 mm - n°14 fori / holes
Art. 08.200 fori / hole □ 16 mm - int. 130 mm - n°14 fori / holes
Art. 08.200.01 fori / hole □ 16 mm - int. 135 mm - n°14 fori / holes

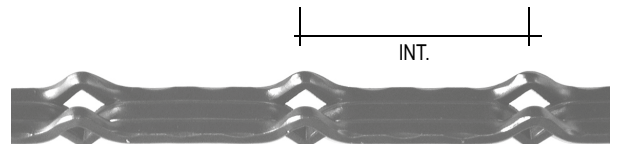

Martellato / *Hammered*
Foro ad asola / *Buttonhole*
H.2000 mm ≇ 40 x 8 mm

Art. 08.200.10 fori / hole □ 12 mm - int. 130 mm - n°14 fori / holes
Art. 08.200.11 fori / hole □ 12 mm - int. 135 mm - n°14 fori / holes
Art. 08.200.12 fori / hole □ 14 mm - int. 130 mm - n°14 fori / holes
Art. 08.200.13 fori / hole □ 14 mm - int. 135 mm - n°14 fori / holes
Art. 08.201 fori / hole □ 16 mm - int. 130 mm - n°14 fori / holes
Art. 08.201.01 fori / hole □ 16 mm - int. 135 mm - n°14 fori / holes

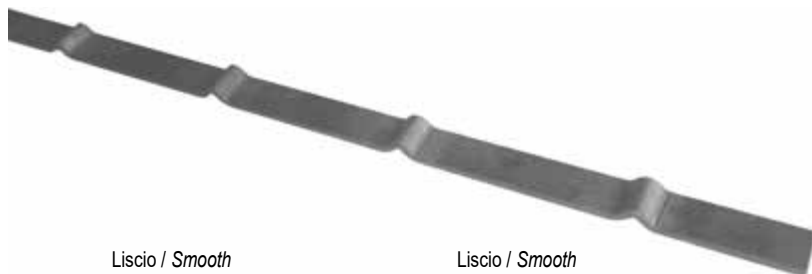

Liscio / *Smooth*
H.2000 mm ≇ 30 x 5 mm
Art. 08.210 □ 14 mm - int. 130 mm
Art. 08.211 □ 14 mm - int. 145 mm

Liscio / *Smooth*
H.2000 mm ≇ 30 x 5 mm
Art. 08.214 □ 16 mm - int. 130 mm
Art. 08.215 □ 16 mm - int. 145 mm

Liscio / *Smooth*
H.3000 mm ≇ 30 x 5 mm
Art. 08.212 □ 14 mm - int. 130 mm
Art. 08.213 □ 14 mm - int. 145 mm

Liscio / *Smooth*
H.3000 mm ≇ 30 x 5 mm
Art. 08.216 □ 16 mm - int. 130 mm
Art. 08.217 □ 16 mm - int. 145 mm

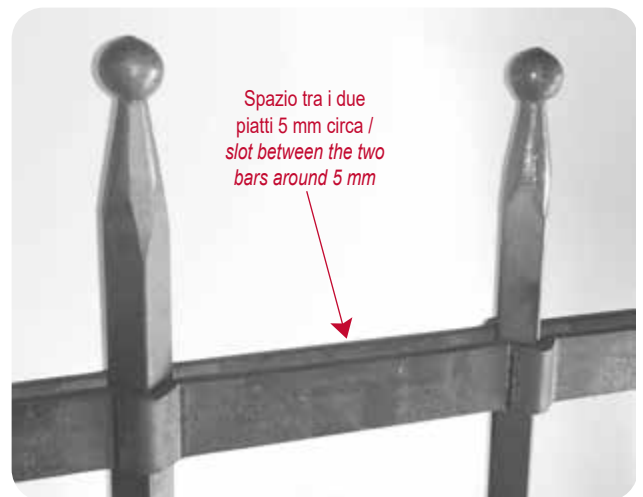

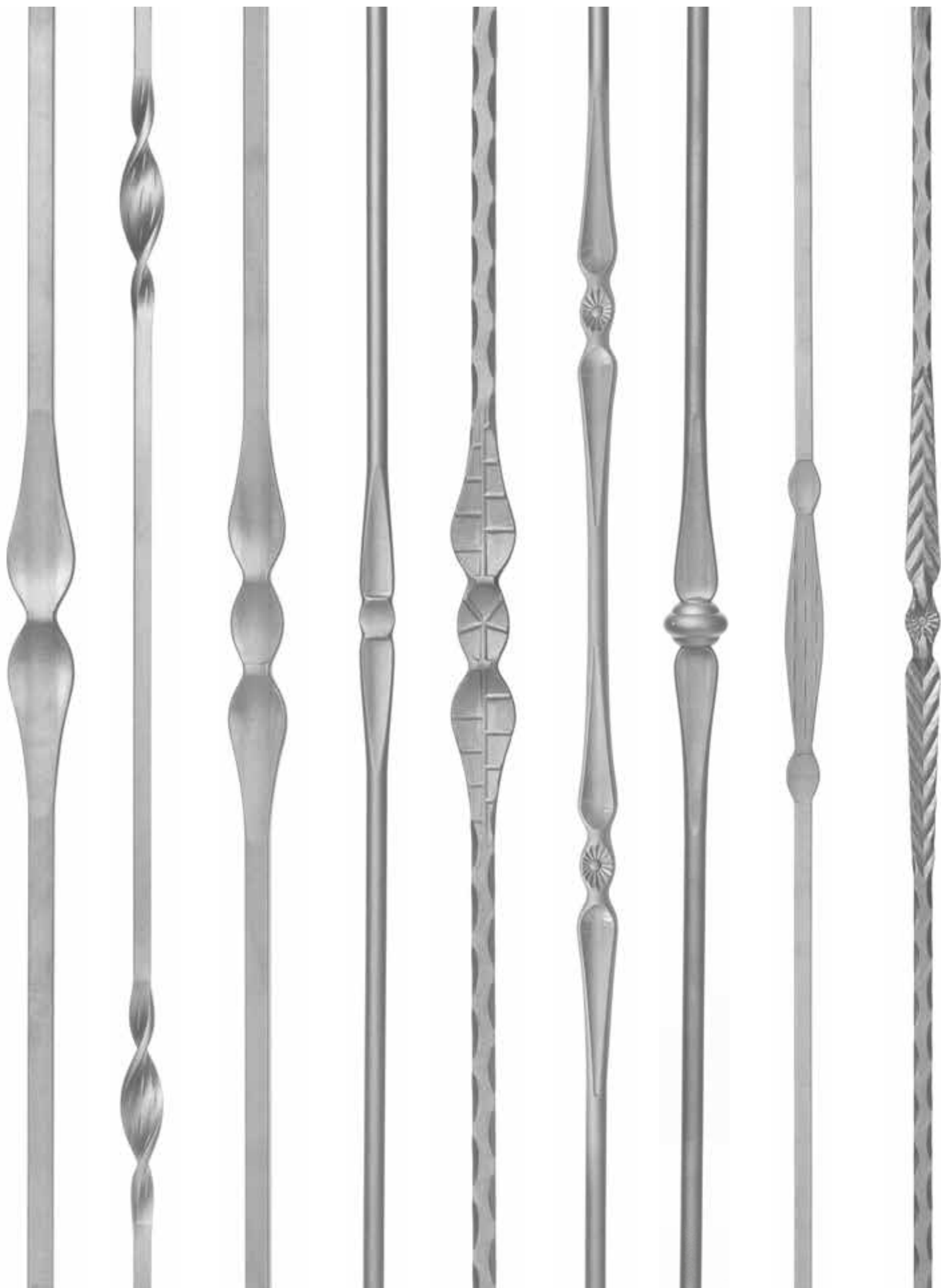

Tutte le parti di questo catalogo - foto comprese - sono di proprietà Euro-Fer. La riproduzione, anche parziale, è vietata in ogni forma e con ogni mezzo. / Every part of this catalogue - photos included - is Euro-Fer's property. All forms of copying are strictly prohibited.

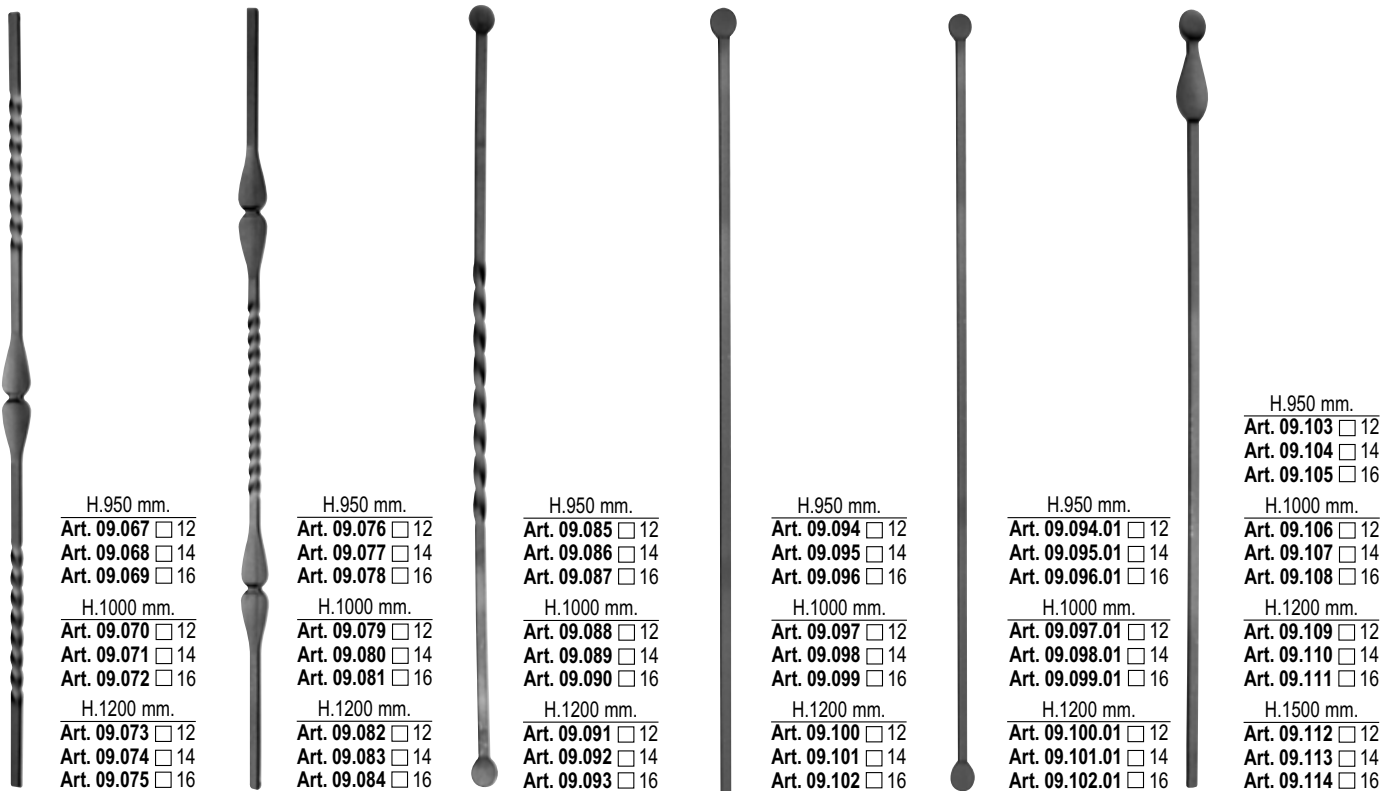
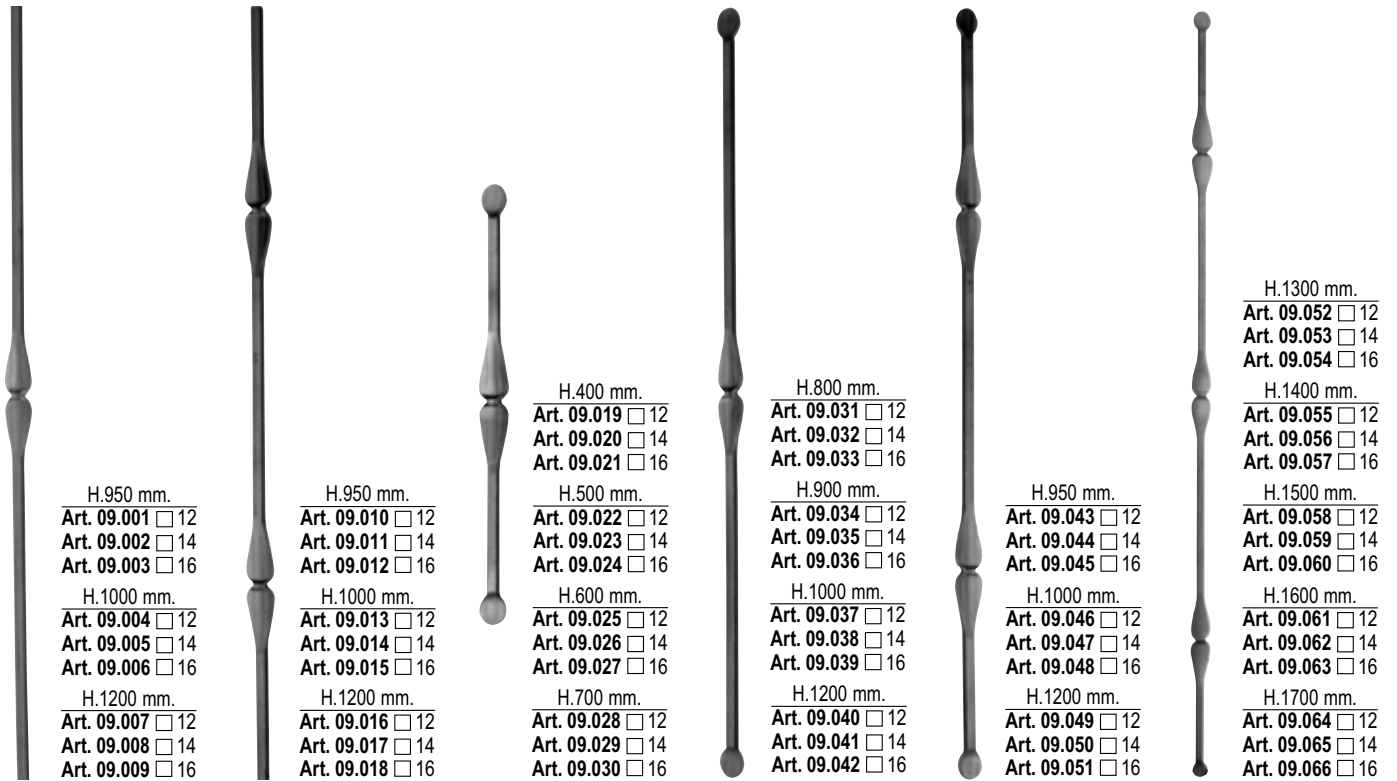

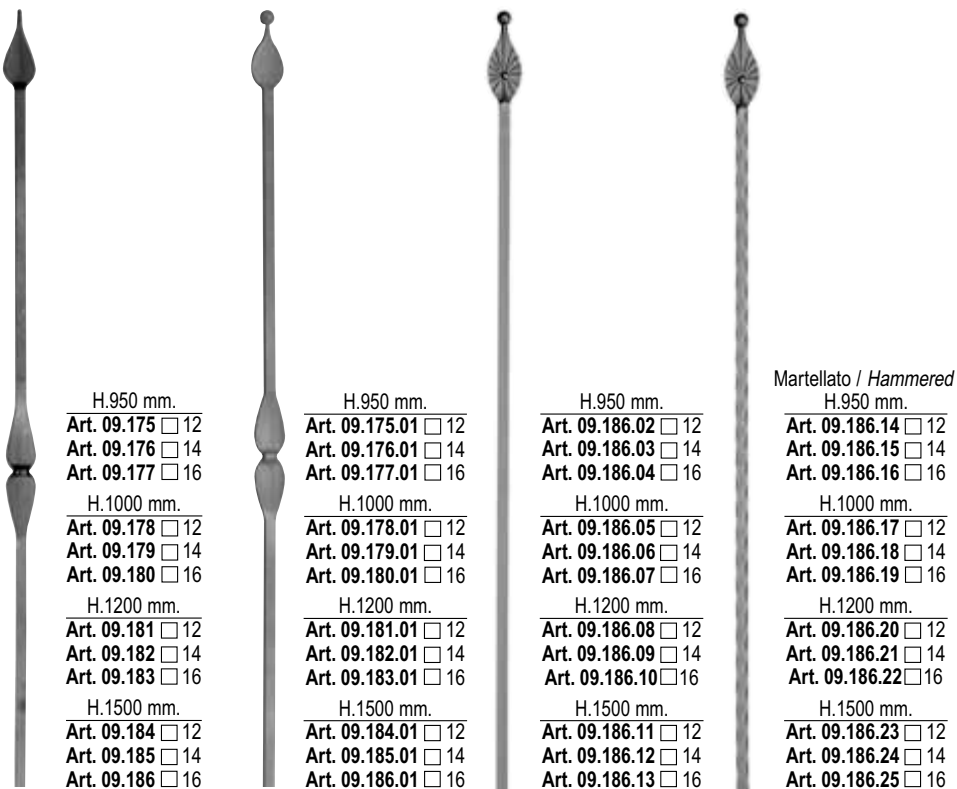
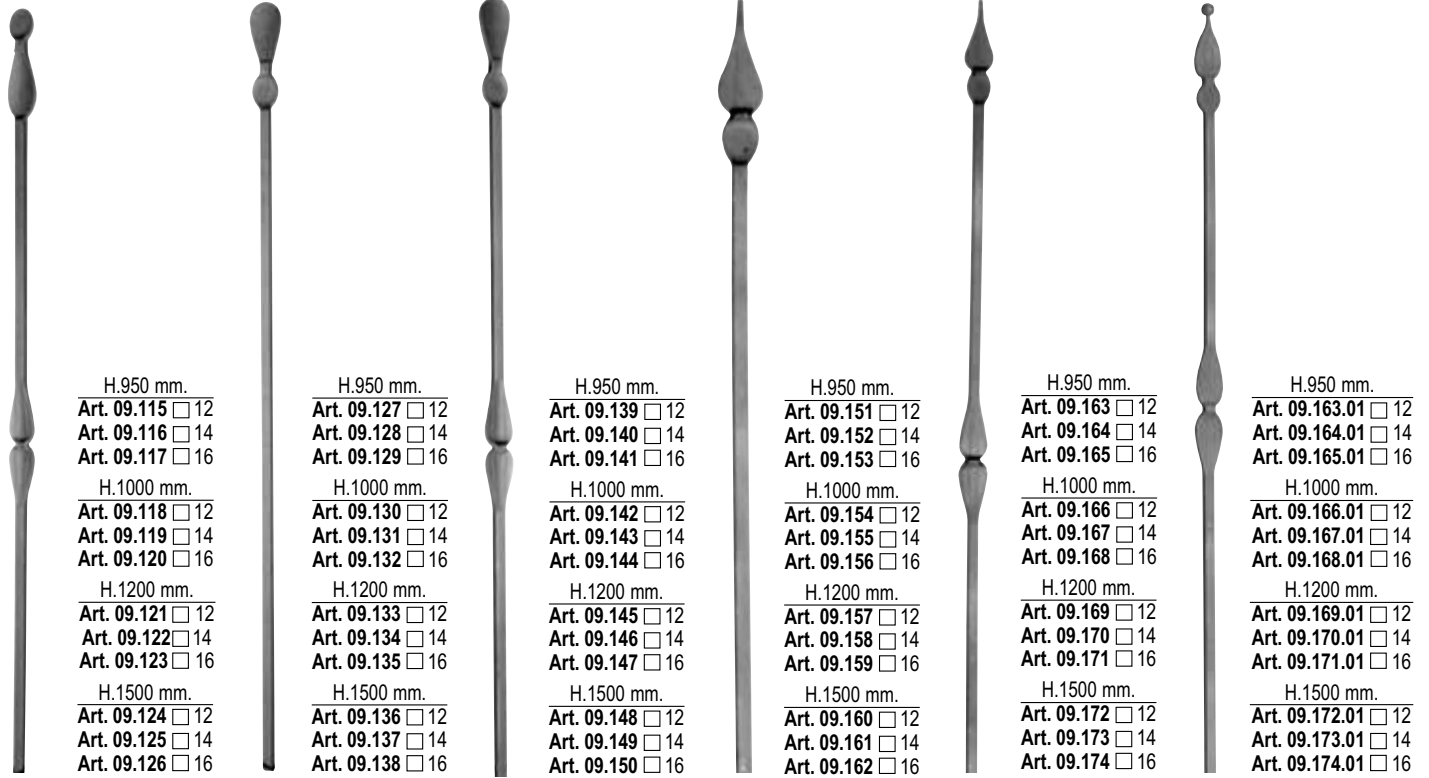

A RICHIESTA CON PALLINA SULLA LANCIA
ON REQUEST WITH BALL ON THE SPEAR

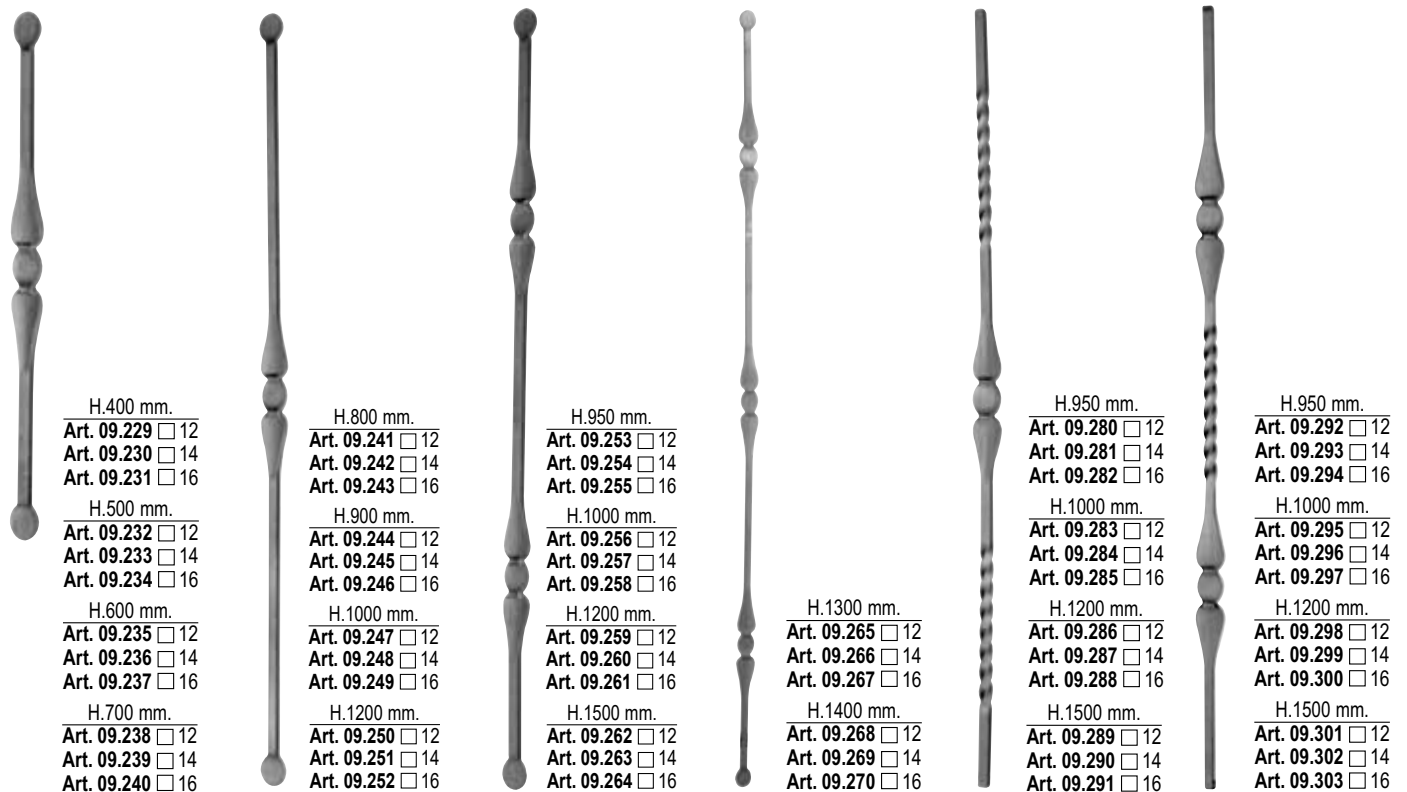
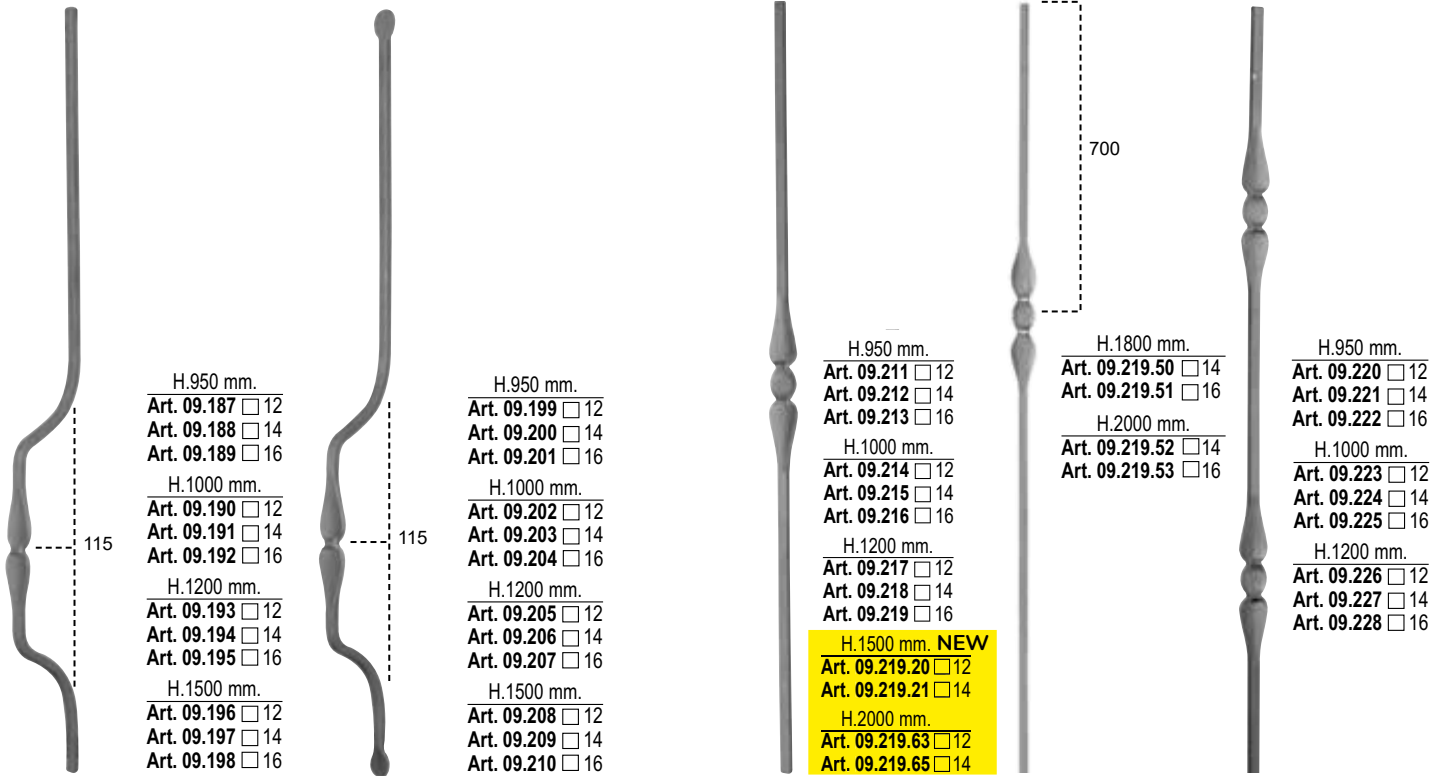

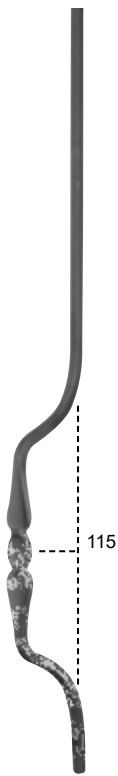

H.950 mm.
 Art. 09.304 12
 Art. 09.305 14
 Art. 09.306 16

H.1000 mm.
 Art. 09.307 12
 Art. 09.308 14
 Art. 09.309 16

H.1200 mm.
 Art. 09.310 12
 Art. 09.311 14
 Art. 09.312 16

H.1500 mm.
 Art. 09.313 12
 Art. 09.314 14
 Art. 09.315 16

H.1800 mm.
 Art. 09.316 12
 Art. 09.317 14
 Art. 09.318 16



H.950 mm.
 Art. 09.319 12
 Art. 09.320 14
 Art. 09.321 16

H.1000 mm.
 Art. 09.322 12
 Art. 09.323 14
 Art. 09.324 16

H.1200 mm.
 Art. 09.325 12
 Art. 09.326 14
 Art. 09.327 16

H.1500 mm.
 Art. 09.328 12
 Art. 09.329 14
 Art. 09.330 16

H.1800 mm.
 Art. 09.331 12
 Art. 09.332 14
 Art. 09.333 16



H.950 mm.
 Art. 09.334 12
 Art. 09.335 14
 Art. 09.336 16

H.1000 mm.
 Art. 09.337 12
 Art. 09.338 14
 Art. 09.339 16

H.1200 mm.
 Art. 09.340 12
 Art. 09.341 14
 Art. 09.342 16

H.1500 mm.
 Art. 09.343 12
 Art. 09.344 14
 Art. 09.345 16

H.1800 mm.
 Art. 09.346 12
 Art. 09.347 14
 Art. 09.348 16

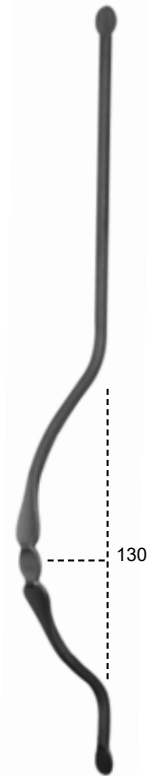

H.950 mm.
 Art. 09.349 12
 Art. 09.350 14
 Art. 09.351 16

H.1000 mm.
 Art. 09.352 12
 Art. 09.353 14
 Art. 09.354 16

H.1200 mm.
 Art. 09.355 12
 Art. 09.356 14
 Art. 09.357 16

H.1500 mm.
 Art. 09.358 12
 Art. 09.359 14
 Art. 09.360 16

H.1800 mm.
 Art. 09.361 12
 Art. 09.362 14
 Art. 09.363 16

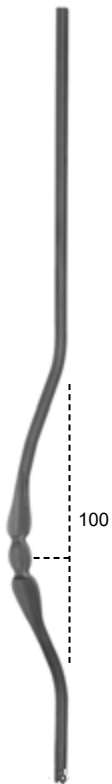

H.950 mm.
 Art. 09.364 12
 Art. 09.365 14
 Art. 09.366 16

H.1000 mm.
 Art. 09.367 12
 Art. 09.368 14
 Art. 09.369 16

H.1200 mm.
 Art. 09.370 12
 Art. 09.371 14
 Art. 09.372 16

H.1500 mm.
 Art. 09.373 12
 Art. 09.374 14
 Art. 09.375 16

H.1800 mm.
 Art. 09.376 12
 Art. 09.377 14



H.950 mm.
 Art. 09.379 12
 Art. 09.380 14
 Art. 09.381 16

H.1000 mm.
 Art. 09.382 12
 Art. 09.383 14
 Art. 09.384 16

H.1200 mm.
 Art. 09.385 12
 Art. 09.386 14
 Art. 09.387 16

H.1500 mm.
 Art. 09.388 12
 Art. 09.389 14
 Art. 09.390 16

H.1800 mm.
 Art. 09.391 12
 Art. 09.392 14
 Art. 09.393 16



H.950 mm.
 Art. 09.394 12
 Art. 09.395 14
 Art. 09.396 16

H.1000 mm.
 Art. 09.397 12
 Art. 09.398 14
 Art. 09.399 16

H.1200 mm.
 Art. 09.400 12
 Art. 09.401 14
 Art. 09.402 16

H.1500 mm.
 Art. 09.403 12
 Art. 09.404 14
 Art. 09.405 16



H.950 mm.
 Art. 09.406 12
 Art. 09.407 14
 Art. 09.408 16

H.1000 mm.
 Art. 09.409 12
 Art. 09.410 14
 Art. 09.411 16

H.1200 mm.
 Art. 09.412 12
 Art. 09.413 14
 Art. 09.414 16

H.1500 mm.
 Art. 09.415 12
 Art. 09.416 14
 Art. 09.417 16



H.950 mm.
 Art. 09.418 12
 Art. 09.419 14
 Art. 09.420 16

H.1000 mm.
 Art. 09.421 12
 Art. 09.422 14
 Art. 09.423 16

H.1200 mm.
 Art. 09.424 12
 Art. 09.425 14
 Art. 09.426 16

H.1500 mm.
 Art. 09.427 12
 Art. 09.428 14
 Art. 09.429 16



A RICHIESTA CON PALLINA SULLA LANCIA
 ON REQUEST WITH BALL ON THE SPEAR



H.950 mm.
Art. 09.430 □ 12
Art. 09.431 □ 14
Art. 09.432 □ 16

H.1000 mm.
Art. 09.433 □ 12
Art. 09.434 □ 14
Art. 09.435 □ 16

H.1200 mm.
Art. 09.436 □ 12
Art. 09.437 □ 14
Art. 09.438 □ 16

H.1500 mm.
Art. 09.439 □ 12
Art. 09.440 □ 14
Art. 09.441 □ 16



H.950 mm.
Art. 09.442 □ 12
Art. 09.443 □ 14
Art. 09.444 □ 16

H.1000 mm.
Art. 09.445 □ 12
Art. 09.446 □ 14
Art. 09.447 □ 16

H.1200 mm.
Art. 09.448 □ 12
Art. 09.449 □ 14
Art. 09.450 □ 16

H.1500 mm.
Art. 09.451 □ 12
Art. 09.452 □ 14
Art. 09.453 □ 16



H.950 mm.
Art. 09.442.01 □ 12
Art. 09.443.01 □ 14
Art. 09.444.01 □ 16

H.1000 mm.
Art. 09.445.01 □ 12
Art. 09.446.01 □ 14
Art. 09.447.01 □ 16

H.1200 mm.
Art. 09.448.01 □ 12
Art. 09.449.01 □ 14
Art. 09.450.01 □ 16

H.1500 mm.
Art. 09.451.01 □ 12
Art. 09.452.01 □ 14
Art. 09.453.01 □ 16



H.950 mm.
Art. 09.454 □ 12
Art. 09.455 □ 14
Art. 09.456 □ 16

H.1000 mm.
Art. 09.457 □ 12
Art. 09.458 □ 14
Art. 09.459 □ 16

H.1200 mm.
Art. 09.460 □ 12
Art. 09.461 □ 14
Art. 09.462 □ 16

H.1500 mm.
Art. 09.463 □ 12
Art. 09.464 □ 14
Art. 09.465 □ 16



H.950 mm.
Art. 09.454.01 □ 12
Art. 09.455.01 □ 14
Art. 09.456.01 □ 16

H.1000 mm.
Art. 09.457.01 □ 12
Art. 09.458.01 □ 14
Art. 09.459.01 □ 16

H.1200 mm.
Art. 09.460.01 □ 12
Art. 09.461.01 □ 14
Art. 09.462.01 □ 16

H.1500 mm.
Art. 09.463.01 □ 12
Art. 09.464.01 □ 14
Art. 09.465.01 □ 16

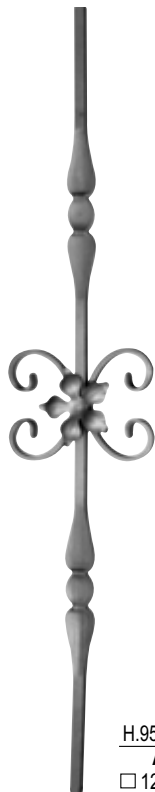

H.950 X L.175 mm.
Art. 09.466
□ 12 ≧ 12 X 6

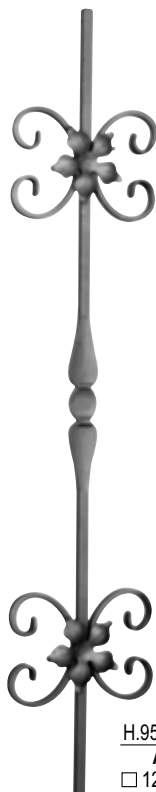

H.950 X L.175 mm.
Art. 09.467
□ 12 ≧ 12 X 6



H.950 X L.150 mm.
Art. 09.468
□ 12 ≧ 12 X 6



Martel. / *Hammered*
H.950 mm.
Art. 09.468.01 □ 12
Art. 09.468.02 □ 14
Art. 09.468.03 □ 16

H.1000 mm.
Art. 09.468.04 □ 12
Art. 09.468.05 □ 14
Art. 09.468.06 □ 16

H.1200 mm.
Art. 09.468.07 □ 12
Art. 09.468.08 □ 14
Art. 09.468.09 □ 16

H.1500 mm.
Art. 09.468.10 □ 12
Art. 09.468.11 □ 14
Art. 09.468.12 □ 16



Martel. / *Hammered*
H.950 mm.
Art. 09.468.13 □ 12
Art. 09.468.14 □ 14
Art. 09.468.15 □ 16

H.1000 mm.
Art. 09.468.16 □ 12
Art. 09.468.17 □ 14
Art. 09.468.18 □ 16

H.1200 mm.
Art. 09.468.19 □ 12
Art. 09.468.20 □ 14
Art. 09.468.21 □ 16

H.1500 mm.
Art. 09.468.22 □ 12
Art. 09.468.23 □ 14
Art. 09.468.24 □ 16

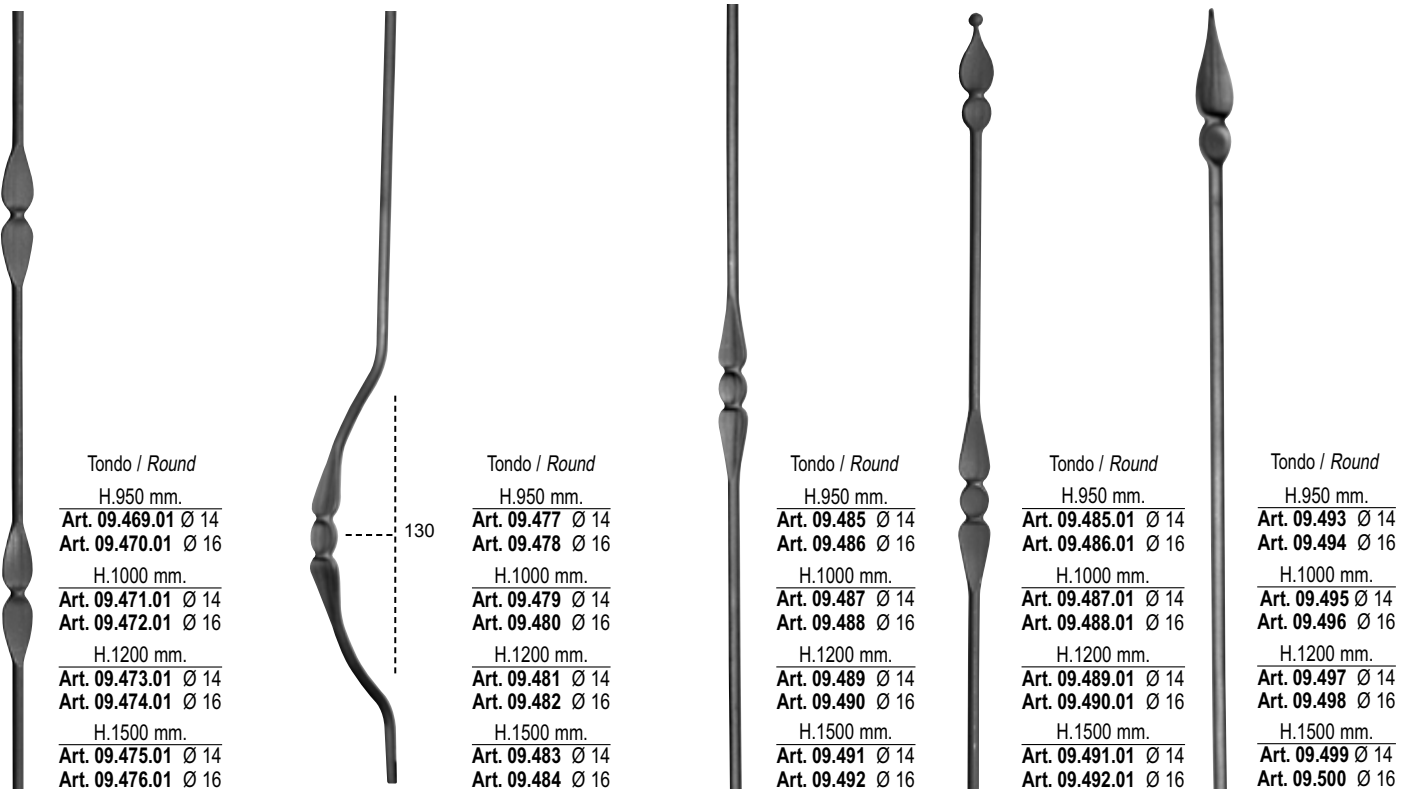
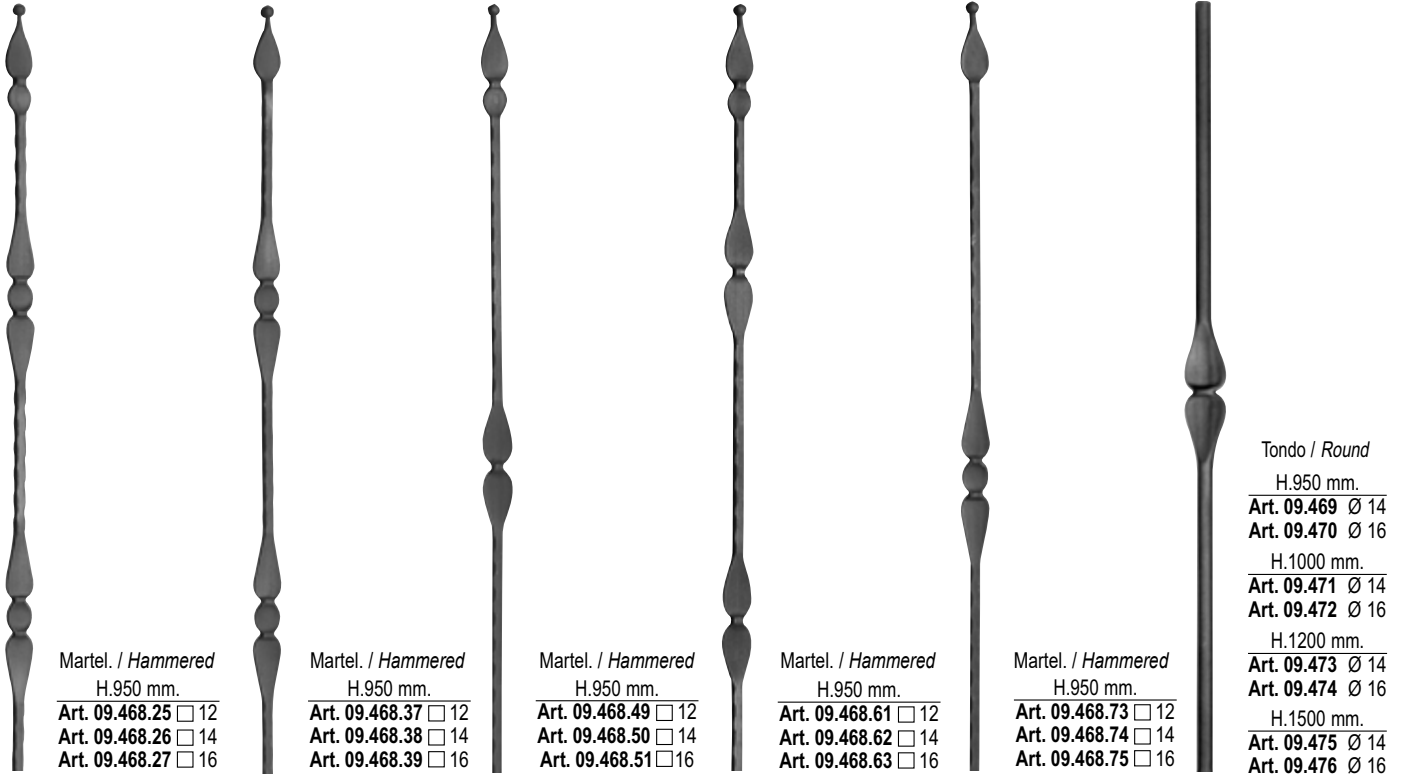

A RICHIESTA CON PALLINA SULLA LANCIA
ON REQUEST WITH BALL ON THE SPEAR



Tondo / Round

H.950 mm.

Art. 09.493.01 Ø 14
Art. 09.494.01 Ø 16

H.1000 mm.

Art. 09.495.01 Ø 14
Art. 09.496.01 Ø 16

H.1200 mm.

Art. 09.497.01 Ø 14
Art. 09.498.01 Ø 16

H.1500 mm.

Art. 09.499.01 Ø 14
Art. 09.500.01 Ø 16



Fiamma grande / Big flame



Tondo / Round

H.950 mm.

Art. 09.500.20 Ø 12

H.1000 mm.

Art. 09.500.23 Ø 12

H.950 mm.

Art. 09.500.30 □ 12

H.1000 mm.

Art. 09.500.33 □ 12



Tondo / Round

H.950 mm.

Art. 09.501 Ø 14
Art. 09.502 Ø 16

H.1000 mm.

Art. 09.503 Ø 14
Art. 09.504 Ø 16

H.1200 mm.

Art. 09.505 Ø 14
Art. 09.506 Ø 16

H.1500 mm.

Art. 09.507 Ø 14
Art. 09.508 Ø 16



Tondo / Round

Borchia tornita / Turned stud
H.950 mm.

Art. 09.509 Ø 14
Art. 09.509.01 Ø 12

Borchia stampata / Stamped stud
H.950 mm.

Art. 09.509.02 Ø 14
Art. 09.509.03 Ø 12



Tondo / Round

Borchia tornita / Turned stud
H.950 mm.

Art. 09.510 Ø 14
Art. 09.510.07 Ø 12

Borchia stampata / Stamped stud
H.950 mm.

Art. 09.510.10 Ø 14
Art. 09.510.12 Ø 12



H.950 mm.

Art. 09.510.03 □ 14
Art. 09.510.05 □ 12



H.950 mm.

Art. 09.510.04 □ 14
Art. 09.510.06 □ 12



H.1500 mm.

Art. 09.510.08 □ 12
Art. 09.510.09 □ 14



550

H.2000 mm.

Art. 09.510.20 □ 12
Art. 09.510.21 □ 14



Sfera vuota
Hollow sphere

H.950 mm.
Art. 09.510.22 Ø 14

H.950 mm.
Art. 09.510.23 Ø 14

H.950 mm.
Art. 09.511 Ø12
H.1000 mm.
Art. 09.512 Ø12
H.1200 mm.
Art. 09.513 Ø12

H.950 mm.
Art. 09.514 Ø12
H.1000 mm.
Art. 09.515 Ø12
H.1200 mm.
Art. 09.516 Ø12

NEW
H.950 mm.
Art. 09.510.48 □ 12
H.950 mm.
Art. 09.510.49 □ 14

NEW
H.950 mm.
Art. 09.510.50 □ 12
H.950 mm.
Art. 09.510.51 □ 14

H.950 mm.
Art. 09.517 Ø14
Art. 09.517.06 □12
Art. 09.517.07 □14

H.950 mm.
Art. 09.517.01 Ø14
Art. 09.517.08 □12
Art. 09.517.09 □14

Liscio / Smooth
H.950 mm.
Art. 09.517.02 Ø14

Liscio / Smooth
H.950 mm.
Art. 09.517.03 Ø14

Fuori Produzione
Out of Production
Art. 09.517.04

Fuori Produzione
Out of Production
Art. 09.517.05

↑ ↑ articoli sostituiti da 09.517.02 e 09.517.03

Tutte le parti di questo catalogo - foto comprese - sono di proprietà Euro-Fer. La riproduzione, anche parziale, è vietata in ogni forma e con ogni mezzo. / Every part of this catalogue - photos included - is Euro-Fer's property. All forms of copying are strictly prohibited.



Martellato / Hammered
H.950 mm.
Art. 09.518 □ 12
Art. 09.519 □ 14
Art. 09.520 □ 16
H.1000 mm.
Art. 09.521 □ 12
Art. 09.522 □ 14
Art. 09.523 □ 16
H.1200 mm.
Art. 09.524 □ 12
Art. 09.525 □ 14
Art. 09.526 □ 16



Martellato / Hammered
H.950 mm.
Art. 09.518.01 □ 12
Art. 09.519.01 □ 14
Art. 09.520.01 □ 16
H.1000 mm.
Art. 09.521.01 □ 12
Art. 09.522.01 □ 14
Art. 09.523.01 □ 16
H.1200 mm.
Art. 09.524.01 □ 12
Art. 09.525.01 □ 14
Art. 09.526.01 □ 16



Martellato / Hammered
H.950 mm.
Art. 09.527 □ 12
Art. 09.528 □ 14
Art. 09.529 □ 16
H.1000 mm.
Art. 09.530 □ 12
Art. 09.531 □ 14
Art. 09.532 □ 16
H.1200 mm.
Art. 09.533 □ 12
Art. 09.534 □ 14
Art. 09.535 □ 16



Martellato / Hammered
H.950 mm.
Art. 09.536 □ 12
Art. 09.537 □ 14
Art. 09.538 □ 16
H.1000 mm.
Art. 09.539 □ 12
Art. 09.540 □ 14
Art. 09.541 □ 16
H.1200 mm.
Art. 09.542 □ 12
Art. 09.543 □ 14
Art. 09.544 □ 16



Martellato / Hammered
H.950 mm.
Art. 09.536.01 □ 12
Art. 09.537.01 □ 14
Art. 09.538.01 □ 16



Martellato / Hammered
H.950 mm.
Art. 09.545 □ 12
Art. 09.546 □ 14
Art. 09.547 □ 16
H.1000 mm.
Art. 09.548 □ 12
Art. 09.549 □ 14
Art. 09.550 □ 16
H.1200 mm.
Art. 09.551 □ 12
Art. 09.552 □ 14
Art. 09.553 □ 16



Martellato / Hammered
H.950 mm.
Art. 09.545.01 □ 12
Art. 09.546.01 □ 14
Art. 09.547.01 □ 16



Martellato / Hammered
H.950 mm.
Art. 09.554 □ 12
Art. 09.555 □ 14
Art. 09.556 □ 16
H.1000 mm.
Art. 09.557 □ 12
Art. 09.558 □ 14
Art. 09.559 □ 16
H.1200 mm.
Art. 09.560 □ 12
Art. 09.561 □ 14
Art. 09.562 □ 16



Martellato / Hammered
H.950 mm.
Art. 09.563 □ 12
Art. 09.564 □ 14
Art. 09.565 □ 16
H.1000 mm.
Art. 09.566 □ 12
Art. 09.567 □ 14
Art. 09.568 □ 16
H.1200 mm.
Art. 09.569 □ 12
Art. 09.570 □ 14
Art. 09.571 □ 16



Martellato / Hammered
H.950 mm.
Art. 09.572 □ 12
Art. 09.573 □ 14
Art. 09.574 □ 16
H.1000 mm.
Art. 09.575 □ 12
Art. 09.576 □ 14
Art. 09.577 □ 16
H.1200 mm.
Art. 09.578 □ 12
Art. 09.579 □ 14
Art. 09.580 □ 16



H.950 mm.
Art. 09.581 □ 12
Art. 09.582 □ 14
Art. 09.583 □ 16
H.1000 mm.
Art. 09.584 □ 12
Art. 09.585 □ 14
Art. 09.586 □ 16
H.1200 mm.
Art. 09.587 □ 12
Art. 09.588 □ 14
Art. 09.589 □ 16

A RICHIESTA CON PALLINA SULLA LANCIA
ON REQUEST WITH BALL ON THE SPEAR



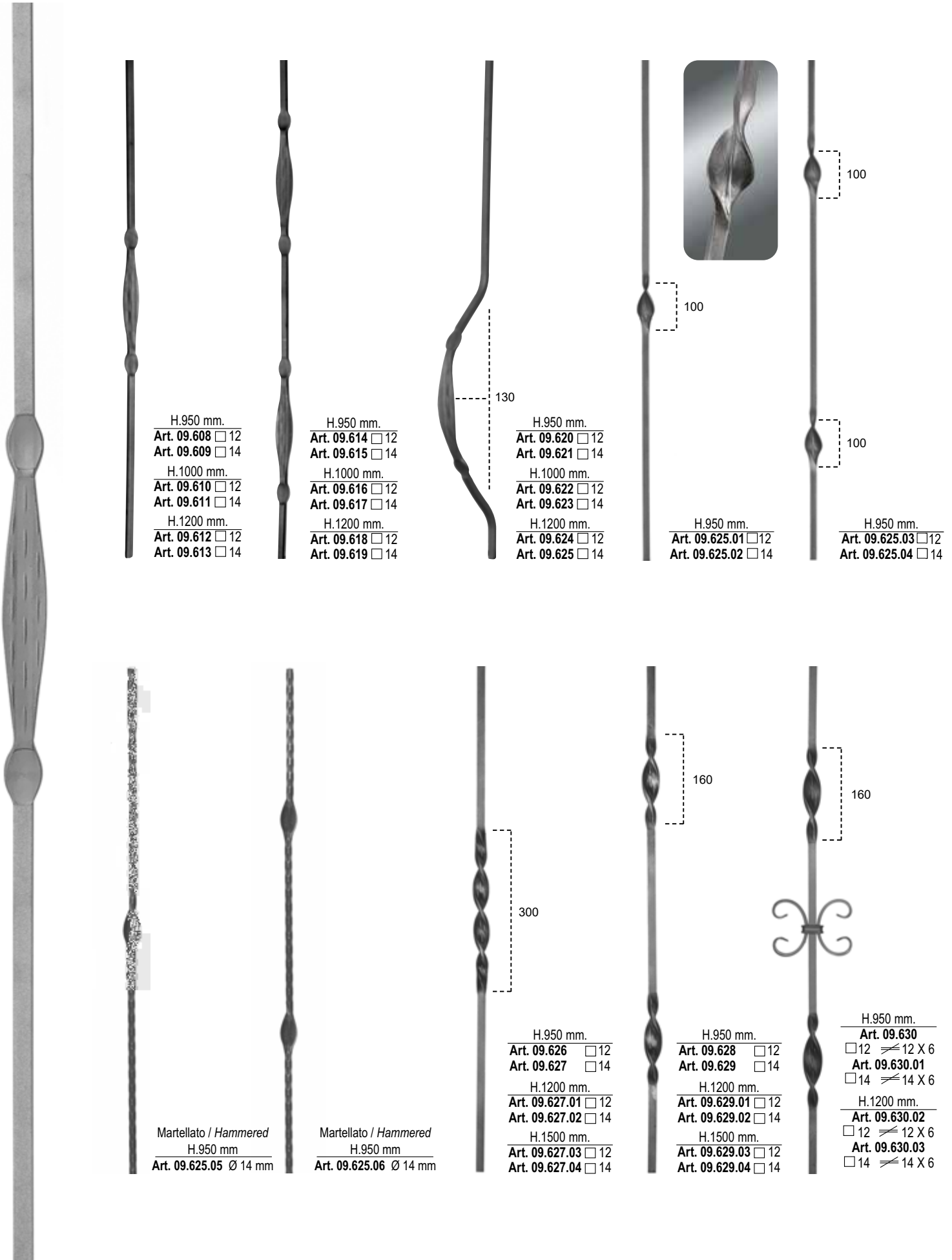

H.950 mm.
Art. 09.608 □ 12
Art. 09.609 □ 14

H.1000 mm.
Art. 09.610 □ 12
Art. 09.611 □ 14

H.1200 mm.
Art. 09.612 □ 12
Art. 09.613 □ 14

H.950 mm.
Art. 09.614 □ 12
Art. 09.615 □ 14

H.1000 mm.
Art. 09.616 □ 12
Art. 09.617 □ 14

H.1200 mm.
Art. 09.618 □ 12
Art. 09.619 □ 14

H.950 mm.
Art. 09.620 □ 12
Art. 09.621 □ 14

H.1000 mm.
Art. 09.622 □ 12
Art. 09.623 □ 14

H.1200 mm.
Art. 09.624 □ 12
Art. 09.625 □ 14

H.950 mm.
Art. 09.625.01 □ 12
Art. 09.625.02 □ 14

H.950 mm.
Art. 09.625.03 □ 12
Art. 09.625.04 □ 14

Martellato / *Hampered*
H.950 mm
Art. 09.625.05 Ø 14 mm

Martellato / *Hampered*
H.950 mm
Art. 09.625.06 Ø 14 mm

H.950 mm.
Art. 09.626 □ 12
Art. 09.627 □ 14

H.1200 mm.
Art. 09.627.01 □ 12
Art. 09.627.02 □ 14

H.1500 mm.
Art. 09.627.03 □ 12
Art. 09.627.04 □ 14

H.950 mm.
Art. 09.628 □ 12
Art. 09.629 □ 14

H.1200 mm.
Art. 09.629.01 □ 12
Art. 09.629.02 □ 14

H.1500 mm.
Art. 09.629.03 □ 12
Art. 09.629.04 □ 14

H.950 mm.
Art. 09.630
□ 12 ≙ 12 X 6
Art. 09.630.01
□ 14 ≙ 14 X 6

H.1200 mm.
Art. 09.630.02
□ 12 ≙ 12 X 6
Art. 09.630.03
□ 14 ≙ 14 X 6

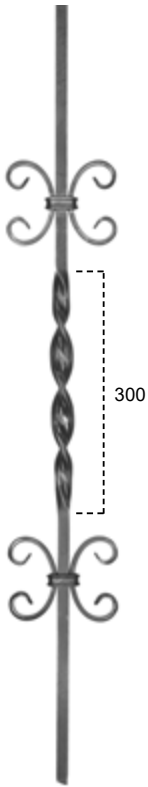

H.950 mm.
Art. 09.631
 12 \neq 12 X 6
Art. 09.631.01
 14 \neq 14 X 6

H.1200 mm.
Art. 09.631.02
 12 \neq 12 X 6
Art. 09.631.03
 14 \neq 14 X 6

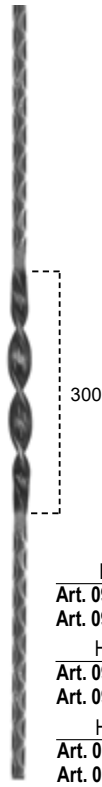

H.950 mm.
Art. 09.631.04 12
Art. 09.631.05 14

H.1200 mm.
Art. 09.631.06 12
Art. 09.631.07 14

H.1500 mm.
Art. 09.631.08 12
Art. 09.631.09 14



H.950 mm.
Art. 09.631.10 12
Art. 09.631.11 14

H.1200 mm.
Art. 09.631.12 12
Art. 09.631.13 14

H.1500 mm.
Art. 09.631.14 12
Art. 09.631.15 14



H.950 mm.
Art. 09.631.16
 12 \neq 12 X 6
Art. 09.631.17
 14 \neq 14 X 6

H.1200 mm.
Art. 09.631.18
 12 \neq 12 X 6
Art. 09.631.19
 14 \neq 14 X 6

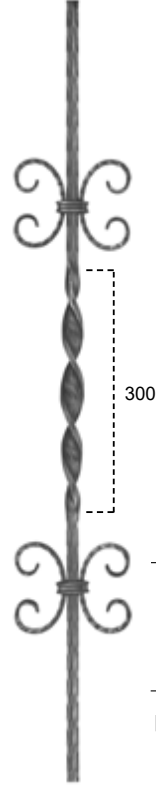

H.950 mm.
Art. 09.631.20
 12 \neq 12 X 6
Art. 09.631.21
 14 \neq 14 X 6

H.1200 mm.
Art. 09.631.22
 12 \neq 12 X 6
Art. 09.631.23
 14 \neq 14 X 6

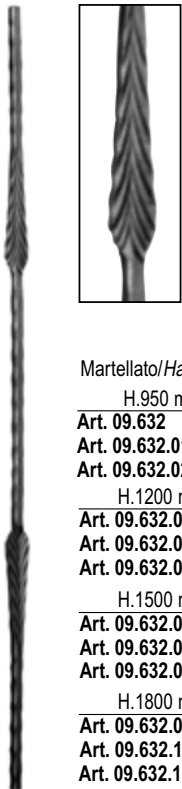

Martellato/Hammered

H.950 mm.
Art. 09.632 12
Art. 09.632.01 14
Art. 09.632.02 16

H.1200 mm.
Art. 09.632.03 12
Art. 09.632.04 14
Art. 09.632.05 16

H.1500 mm.
Art. 09.632.06 12
Art. 09.632.07 14
Art. 09.632.08 16

H.1800 mm.
Art. 09.632.09 12
Art. 09.632.10 14
Art. 09.632.11 16

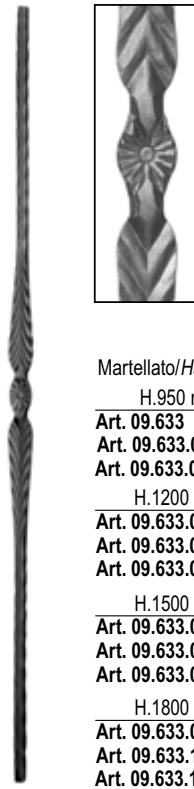

Martellato/Hammered

H.950 mm.
Art. 09.633 12
Art. 09.633.01 14
Art. 09.633.02 16

H.1200 mm.
Art. 09.633.03 12
Art. 09.633.04 14
Art. 09.633.05 16

H.1500 mm.
Art. 09.633.06 12
Art. 09.633.07 14
Art. 09.633.08 16

H.1800 mm.
Art. 09.633.09 12
Art. 09.633.10 14
Art. 09.633.11 16

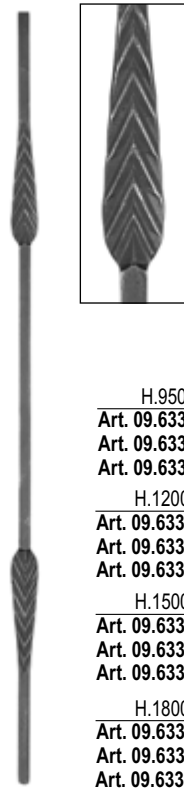

H.950 mm.
Art. 09.633.12 12
Art. 09.633.13 14
Art. 09.633.14 16

H.1200 mm.
Art. 09.633.15 12
Art. 09.633.16 14
Art. 09.633.17 16

H.1500 mm.
Art. 09.633.18 12
Art. 09.633.19 14
Art. 09.633.20 16

H.1800 mm.
Art. 09.633.21 12
Art. 09.633.22 14
Art. 09.633.23 16

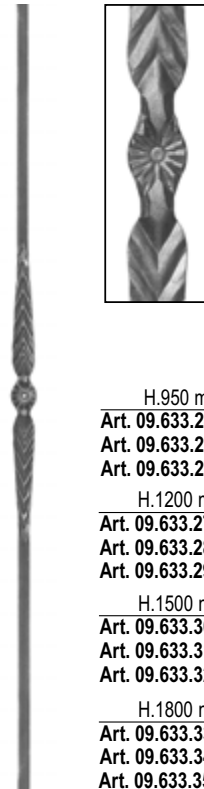

H.950 mm.
Art. 09.633.24 12
Art. 09.633.25 14
Art. 09.633.26 16

H.1200 mm.
Art. 09.633.27 12
Art. 09.633.28 14
Art. 09.633.29 16

H.1500 mm.
Art. 09.633.30 12
Art. 09.633.31 14
Art. 09.633.32 16

H.1800 mm.
Art. 09.633.33 12
Art. 09.633.34 14
Art. 09.633.35 16



Martellato/Hammered
H.1000 X L.140 mm.
Art. 09.634 12
Art. 09.635 14



Martellato/Hammered
H.1000 X L.140 mm.
Art. 09.636 12
Art. 09.637 14



Martellato/Hammered
H.1000 X L.140 mm.
Art. 09.638 12
Art. 09.639 14



Martellato/Hammered
H.950 mm.
Art. 09.640 12
Art. 09.641 14
Art. 09.642 16
H.1000 mm.
Art. 09.643 12
Art. 09.644 14
Art. 09.645 16
H.1200 mm.
Art. 09.646 12
Art. 09.647 14
Art. 09.648 16

Paletti ricalcati / New forged bars



Martellato/Hammered
H.950 mm.
Art. 09.658 12
Art. 09.659 14



Martellato/Hammered
H.950 mm.
Art. 09.660 12
Art. 09.661 14



H.950 mm.
Art. 09.662 12
Art. 09.663 14



H.950 mm.
Art. 09.664 12
Art. 09.665 14



H.950 X L.200mm.
Art. 09.666 Ø14



H.950 X L.200mm.
Art. 09.667 Ø14



A RICHIESTA CON PALLINA SULLA LANCIA
ON REQUEST WITH BALL ON THE SPEAR



Martellato. / *Hammered*

H. 950 X L. 130 mm.

- Art. 09.668 12
- Art. 09.669 14
- Art. 09.669.01 16

H. 1200 X L. 130 mm.

- Art. 09.669.02 12
- Art. 09.669.03 14
- Art. 09.669.04 16

H. 1500 X L. 130 mm.

- Art. 09.669.05 12
- Art. 09.669.06 14
- Art. 09.669.07 16

H. 1800 X L. 130 mm.

- Art. 09.669.08 12
- Art. 09.669.09 14
- Art. 09.669.10 16



H. 950 X L. 130 mm.

Art. 09.671.01 Ø 14



H.950 mm.

- Art. 09.672 12
- Art. 09.673 14
- Art. 09.674 16

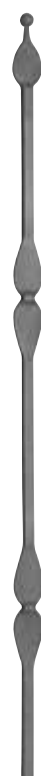

H.950 mm.

- Art. 09.684 12
- Art. 09.685 14
- Art. 09.686 16



H.950 mm.

- Art. 09.696 12
- Art. 09.697 14
- Art. 09.698 16



H.950 mm.

- Art. 09.708 12
- Art. 09.709 14
- Art. 09.710 16

H.1200 mm.

- Art. 09.711 12
- Art. 09.712 14
- Art. 09.713 16

H.1500 mm.

- Art. 09.714 12
- Art. 09.715 14
- Art. 09.716 16

H.1800 mm.

- Art. 09.717 12
- Art. 09.718 14
- Art. 09.719 16



Martel. / *Hammered*

H.950 mm.

- Art. 09.720 12
- Art. 09.721 14
- Art. 09.722 16

H.1200 mm.

- Art. 09.723 12
- Art. 09.724 14
- Art. 09.725 16

H.1500 mm.

- Art. 09.726 12
- Art. 09.727 14
- Art. 09.728 16

H.1800 mm.

- Art. 09.729 12
- Art. 09.730 14
- Art. 09.731 16



H.950 mm.

- Art. 09.732 Ø 14
- Art. 09.733 Ø 16

H.1200 mm.

- Art. 09.734 Ø 14
- Art. 09.735 Ø 16

H.1500 mm.

- Art. 09.736 Ø 14
- Art. 09.737 Ø 16

H.1800 mm.

- Art. 09.738 Ø 14
- Art. 09.739 Ø 16

Palline piccole / *Small Balls*



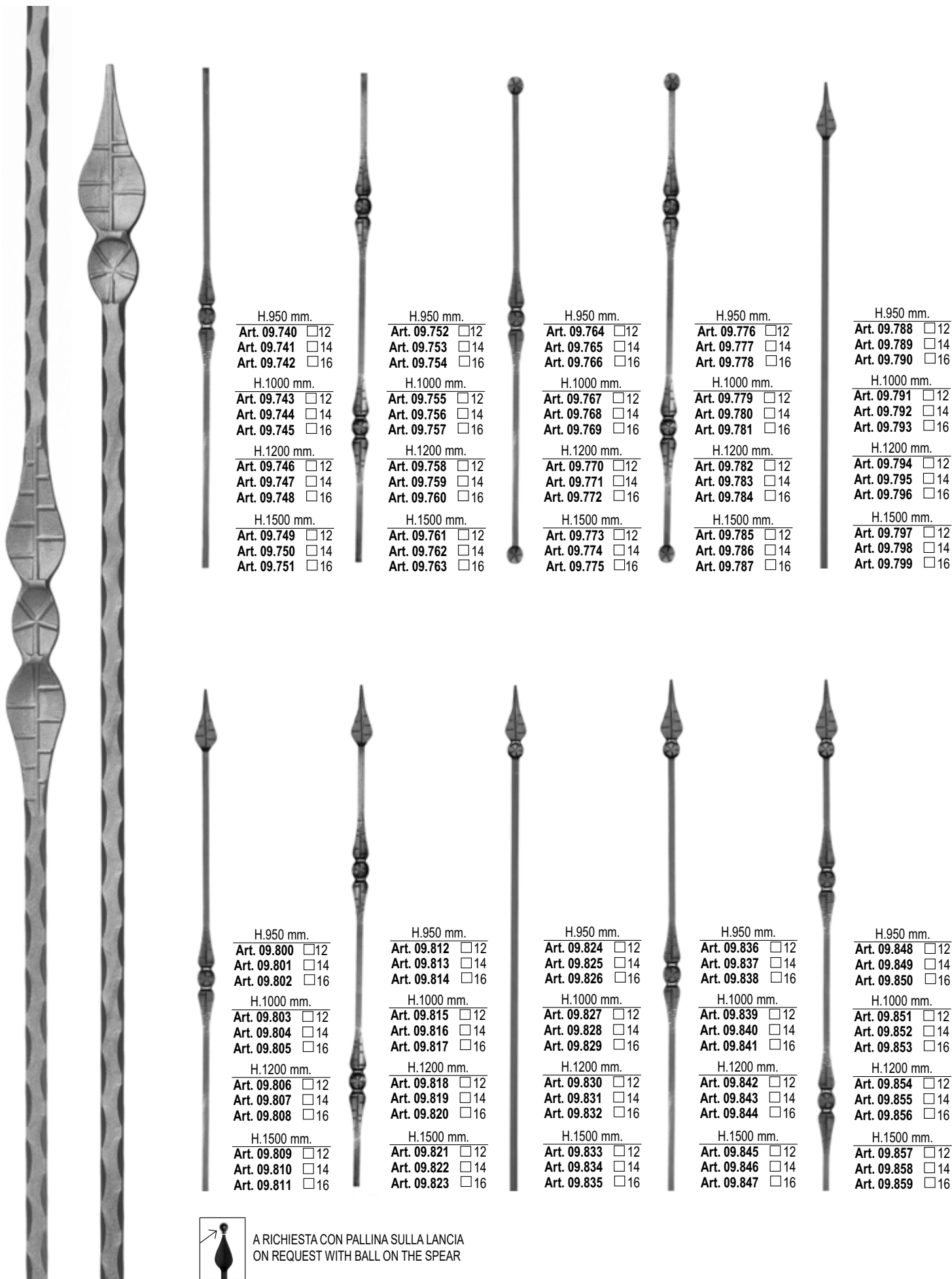

H.950 mm.
Art. 09.740 12
Art. 09.741 14
Art. 09.742 16

H.1000 mm.
Art. 09.743 12
Art. 09.744 14
Art. 09.745 16

H.1200 mm.
Art. 09.746 12
Art. 09.747 14
Art. 09.748 16

H.1500 mm.
Art. 09.749 12
Art. 09.750 14
Art. 09.751 16

H.950 mm.
Art. 09.752 12
Art. 09.753 14
Art. 09.754 16

H.1000 mm.
Art. 09.755 12
Art. 09.756 14
Art. 09.757 16

H.1200 mm.
Art. 09.758 12
Art. 09.759 14
Art. 09.760 16

H.1500 mm.
Art. 09.761 12
Art. 09.762 14
Art. 09.763 16

H.950 mm.
Art. 09.764 12
Art. 09.765 14
Art. 09.766 16

H.1000 mm.
Art. 09.767 12
Art. 09.768 14
Art. 09.769 16

H.1200 mm.
Art. 09.770 12
Art. 09.771 14
Art. 09.772 16

H.1500 mm.
Art. 09.773 12
Art. 09.774 14
Art. 09.775 16

H.950 mm.
Art. 09.776 12
Art. 09.777 14
Art. 09.778 16

H.1000 mm.
Art. 09.779 12
Art. 09.780 14
Art. 09.781 16

H.1200 mm.
Art. 09.782 12
Art. 09.783 14
Art. 09.784 16

H.1500 mm.
Art. 09.785 12
Art. 09.786 14
Art. 09.787 16

H.950 mm.
Art. 09.788 12
Art. 09.789 14
Art. 09.790 16

H.1000 mm.
Art. 09.791 12
Art. 09.792 14
Art. 09.793 16

H.1200 mm.
Art. 09.794 12
Art. 09.795 14
Art. 09.796 16

H.1500 mm.
Art. 09.797 12
Art. 09.798 14
Art. 09.799 16

H.950 mm.
Art. 09.800 12
Art. 09.801 14
Art. 09.802 16

H.1000 mm.
Art. 09.803 12
Art. 09.804 14
Art. 09.805 16

H.1200 mm.
Art. 09.806 12
Art. 09.807 14
Art. 09.808 16

H.1500 mm.
Art. 09.809 12
Art. 09.810 14
Art. 09.811 16

H.950 mm.
Art. 09.812 12
Art. 09.813 14
Art. 09.814 16

H.1000 mm.
Art. 09.815 12
Art. 09.816 14
Art. 09.817 16

H.1200 mm.
Art. 09.818 12
Art. 09.819 14
Art. 09.820 16

H.1500 mm.
Art. 09.821 12
Art. 09.822 14
Art. 09.823 16

H.950 mm.
Art. 09.824 12
Art. 09.825 14
Art. 09.826 16

H.1000 mm.
Art. 09.827 12
Art. 09.828 14
Art. 09.829 16

H.1200 mm.
Art. 09.830 12
Art. 09.831 14
Art. 09.832 16

H.1500 mm.
Art. 09.833 12
Art. 09.834 14
Art. 09.835 16

H.950 mm.
Art. 09.836 12
Art. 09.837 14
Art. 09.838 16

H.1000 mm.
Art. 09.839 12
Art. 09.840 14
Art. 09.841 16

H.1200 mm.
Art. 09.842 12
Art. 09.843 14
Art. 09.844 16

H.1500 mm.
Art. 09.845 12
Art. 09.846 14
Art. 09.847 16

H.950 mm.
Art. 09.848 12
Art. 09.849 14
Art. 09.850 16

H.1000 mm.
Art. 09.851 12
Art. 09.852 14
Art. 09.853 16

H.1200 mm.
Art. 09.854 12
Art. 09.855 14
Art. 09.856 16

H.1500 mm.
Art. 09.857 12
Art. 09.858 14
Art. 09.859 16

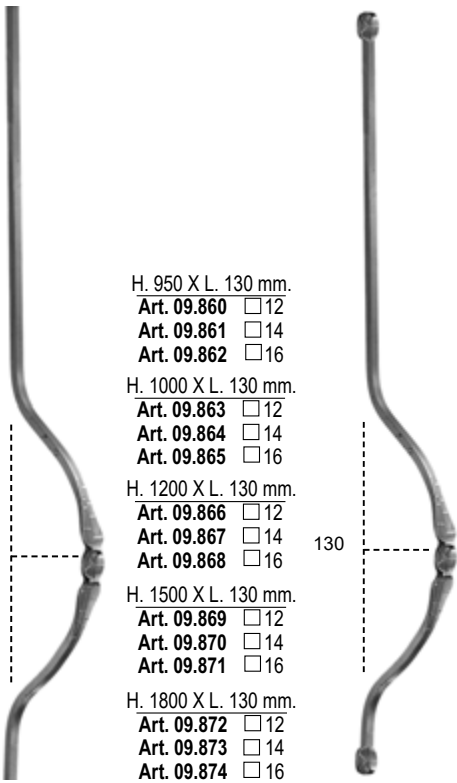
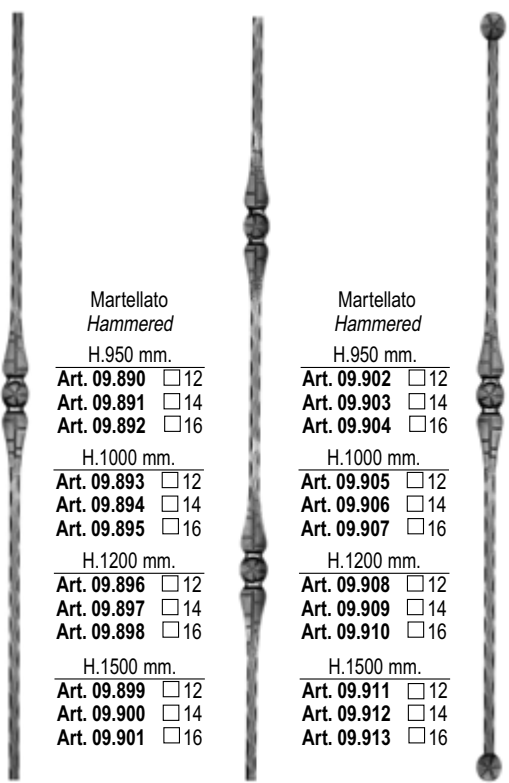

A RICHIESTA CON PALLINA SULLA LANCIA
ON REQUEST WITH BALL ON THE SPEAR

	H. 950 X L. 130 mm. Art. 09.860 <input type="checkbox"/> 12 Art. 09.861 <input type="checkbox"/> 14 Art. 09.862 <input type="checkbox"/> 16	H. 950 X L. 130 mm. Art. 09.875 <input type="checkbox"/> 12 Art. 09.876 <input type="checkbox"/> 14 Art. 09.877 <input type="checkbox"/> 16		Martellato Hammered H.950 mm. Art. 09.890 <input type="checkbox"/> 12 Art. 09.891 <input type="checkbox"/> 14 Art. 09.892 <input type="checkbox"/> 16	Martellato Hammered H.950 mm. Art. 09.902 <input type="checkbox"/> 12 Art. 09.903 <input type="checkbox"/> 14 Art. 09.904 <input type="checkbox"/> 16	Martellato Hammered H.950 mm. Art. 09.914 <input type="checkbox"/> 12 Art. 09.915 <input type="checkbox"/> 14 Art. 09.916 <input type="checkbox"/> 16
	H. 1000 X L. 130 mm. Art. 09.863 <input type="checkbox"/> 12 Art. 09.864 <input type="checkbox"/> 14 Art. 09.865 <input type="checkbox"/> 16	H. 1000 X L. 130 mm. Art. 09.878 <input type="checkbox"/> 12 Art. 09.879 <input type="checkbox"/> 14 Art. 09.880 <input type="checkbox"/> 16		H. 1000 mm. Art. 09.893 <input type="checkbox"/> 12 Art. 09.894 <input type="checkbox"/> 14 Art. 09.895 <input type="checkbox"/> 16	H.1000 mm. Art. 09.905 <input type="checkbox"/> 12 Art. 09.906 <input type="checkbox"/> 14 Art. 09.907 <input type="checkbox"/> 16	H.1000 mm. Art. 09.917 <input type="checkbox"/> 12 Art. 09.918 <input type="checkbox"/> 14 Art. 09.919 <input type="checkbox"/> 16
	H. 1200 X L. 130 mm. Art. 09.866 <input type="checkbox"/> 12 Art. 09.867 <input type="checkbox"/> 14 Art. 09.868 <input type="checkbox"/> 16	H. 1200 X L. 130 mm. Art. 09.881 <input type="checkbox"/> 12 Art. 09.882 <input type="checkbox"/> 14 Art. 09.883 <input type="checkbox"/> 16		H.1200 mm. Art. 09.896 <input type="checkbox"/> 12 Art. 09.897 <input type="checkbox"/> 14 Art. 09.898 <input type="checkbox"/> 16	H.1200 mm. Art. 09.908 <input type="checkbox"/> 12 Art. 09.909 <input type="checkbox"/> 14 Art. 09.910 <input type="checkbox"/> 16	H.1200 mm. Art. 09.920 <input type="checkbox"/> 12 Art. 09.921 <input type="checkbox"/> 14 Art. 09.922 <input type="checkbox"/> 16
	H. 1500 X L. 130 mm. Art. 09.869 <input type="checkbox"/> 12 Art. 09.870 <input type="checkbox"/> 14 Art. 09.871 <input type="checkbox"/> 16	H. 1500 X L. 130 mm. Art. 09.884 <input type="checkbox"/> 12 Art. 09.885 <input type="checkbox"/> 14 Art. 09.886 <input type="checkbox"/> 16		H.1500 mm. Art. 09.899 <input type="checkbox"/> 12 Art. 09.900 <input type="checkbox"/> 14 Art. 09.901 <input type="checkbox"/> 16	H.1500 mm. Art. 09.911 <input type="checkbox"/> 12 Art. 09.912 <input type="checkbox"/> 14 Art. 09.913 <input type="checkbox"/> 16	H.1500 mm. Art. 09.923 <input type="checkbox"/> 12 Art. 09.924 <input type="checkbox"/> 14 Art. 09.925 <input type="checkbox"/> 16
	H. 1800 X L. 130 mm. Art. 09.872 <input type="checkbox"/> 12 Art. 09.873 <input type="checkbox"/> 14 Art. 09.874 <input type="checkbox"/> 16	H. 1800 X L. 130 mm. Art. 09.887 <input type="checkbox"/> 12 Art. 09.888 <input type="checkbox"/> 14 Art. 09.889 <input type="checkbox"/> 16				

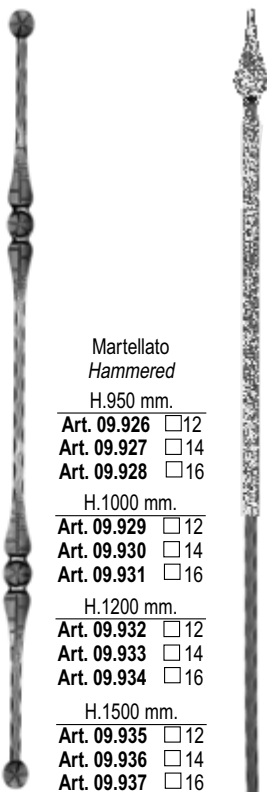
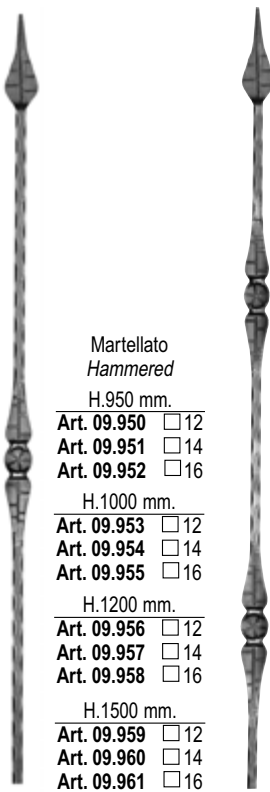
	Martellato Hammered H.950 mm. Art. 09.926 <input type="checkbox"/> 12 Art. 09.927 <input type="checkbox"/> 14 Art. 09.928 <input type="checkbox"/> 16	Martellato Hammered H.950 mm. Art. 09.938 <input type="checkbox"/> 12 Art. 09.939 <input type="checkbox"/> 14 Art. 09.940 <input type="checkbox"/> 16		Martellato Hammered H.950 mm. Art. 09.950 <input type="checkbox"/> 12 Art. 09.951 <input type="checkbox"/> 14 Art. 09.952 <input type="checkbox"/> 16	Martellato Hammered H.950 mm. Art. 09.962 <input type="checkbox"/> 12 Art. 09.963 <input type="checkbox"/> 14 Art. 09.964 <input type="checkbox"/> 16	Martellato Hammered H.950 mm. Art. 09.974 <input type="checkbox"/> 12 Art. 09.975 <input type="checkbox"/> 14 Art. 09.976 <input type="checkbox"/> 16
	H.1000 mm. Art. 09.929 <input type="checkbox"/> 12 Art. 09.930 <input type="checkbox"/> 14 Art. 09.931 <input type="checkbox"/> 16	H.1000 mm. Art. 09.941 <input type="checkbox"/> 12 Art. 09.942 <input type="checkbox"/> 14 Art. 09.943 <input type="checkbox"/> 16		H.1000 mm. Art. 09.953 <input type="checkbox"/> 12 Art. 09.954 <input type="checkbox"/> 14 Art. 09.955 <input type="checkbox"/> 16	H.1000 mm. Art. 09.965 <input type="checkbox"/> 12 Art. 09.966 <input type="checkbox"/> 14 Art. 09.967 <input type="checkbox"/> 16	H.1000 mm. Art. 09.977 <input type="checkbox"/> 12 Art. 09.978 <input type="checkbox"/> 14 Art. 09.979 <input type="checkbox"/> 16
	H.1200 mm. Art. 09.932 <input type="checkbox"/> 12 Art. 09.933 <input type="checkbox"/> 14 Art. 09.934 <input type="checkbox"/> 16	H.1200 mm. Art. 09.944 <input type="checkbox"/> 12 Art. 09.945 <input type="checkbox"/> 14 Art. 09.946 <input type="checkbox"/> 16		H.1200 mm. Art. 09.956 <input type="checkbox"/> 12 Art. 09.957 <input type="checkbox"/> 14 Art. 09.958 <input type="checkbox"/> 16	H.1200 mm. Art. 09.968 <input type="checkbox"/> 12 Art. 09.969 <input type="checkbox"/> 14 Art. 09.970 <input type="checkbox"/> 16	H.1200 mm. Art. 09.980 <input type="checkbox"/> 12 Art. 09.981 <input type="checkbox"/> 14 Art. 09.982 <input type="checkbox"/> 16
	H.1500 mm. Art. 09.935 <input type="checkbox"/> 12 Art. 09.936 <input type="checkbox"/> 14 Art. 09.937 <input type="checkbox"/> 16	H.1500 mm. Art. 09.947 <input type="checkbox"/> 12 Art. 09.948 <input type="checkbox"/> 14 Art. 09.949 <input type="checkbox"/> 16		H.1500 mm. Art. 09.959 <input type="checkbox"/> 12 Art. 09.960 <input type="checkbox"/> 14 Art. 09.961 <input type="checkbox"/> 16	H.1500 mm. Art. 09.971 <input type="checkbox"/> 12 Art. 09.972 <input type="checkbox"/> 14 Art. 09.973 <input type="checkbox"/> 16	H.1500 mm. Art. 09.983 <input type="checkbox"/> 12 Art. 09.984 <input type="checkbox"/> 14 Art. 09.985 <input type="checkbox"/> 16

A RICHIESTA CON PALLINA SULLA LANCIA
ON REQUEST WITH BALL ON THE SPEAR

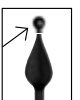



Martellato
Hammered

H.950 mm.
Art. 09.998 12
Art. 09.999 14
Art. 09.999.01 16

H.1000 mm.
Art. 09.999.02 12
Art. 09.999.03 14
Art. 09.999.04 16

H.1200 mm.
Art. 09.999.05 12
Art. 09.999.06 14
Art. 09.999.07 16

H.1500 mm.
Art. 09.999.08 12
Art. 09.999.09 14
Art. 09.999.10 16

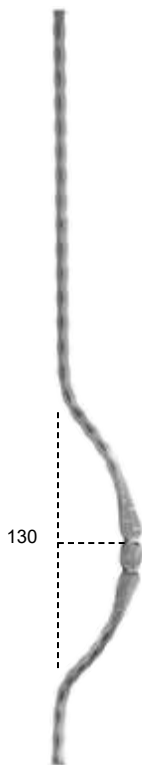

Martellato
Hammered

H.950 mm.
Art. 09.999.11 12
Art. 09.999.12 14
Art. 09.999.13 16

H.1000 mm.
Art. 09.999.14 12
Art. 09.999.15 14
Art. 09.999.16 16

H.1200 mm.
Art. 09.999.17 12
Art. 09.999.18 14
Art. 09.999.19 16

H.1500 mm.
Art. 09.999.20 12
Art. 09.999.21 14
Art. 09.999.22 16

H.1800 mm.
Art. 09.999.23 12
Art. 09.999.24 14
Art. 09.999.25 16

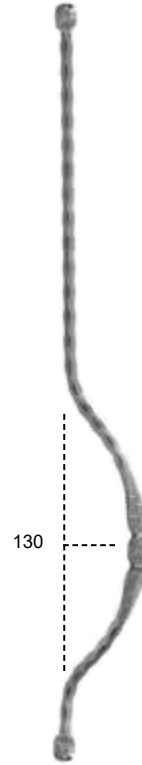

Martellato
Hammered

H.950 mm.
Art. 09.999.26 12
Art. 09.999.27 14
Art. 09.999.28 16

H.1000 mm.
Art. 09.999.29 12
Art. 09.999.30 14
Art. 09.999.31 16

H.1200 mm.
Art. 09.999.32 12
Art. 09.999.33 14
Art. 09.999.34 16

H.1500 mm.
Art. 09.999.35 12
Art. 09.999.36 14
Art. 09.999.37 16

H.1800 mm.
Art. 09.999.38 12
Art. 09.999.39 14
Art. 09.999.40 16



Martellato/Hammered

H.950 mm.
Art. 09.1002.01 12
Art. 09.1002.02 14
Art. 09.1002.03 16

H.1000 mm.
Art. 09.1002.04 12
Art. 09.1002.05 14
Art. 09.1002.06 16

H.1200 mm.
Art. 09.1002.07 12
Art. 09.1002.08 14
Art. 09.1002.09 16

H.1500 mm.
Art. 09.1002.10 12
Art. 09.1002.11 14
Art. 09.1002.12 16



Liscio / Smooth

H.950 mm.
Art. 09.1003 14
Art. 09.1003.01 16

H.1000 mm.
Art. 09.1003.02 14
Art. 09.1003.03 16

H.1200 mm.
Art. 09.1003.04 14
Art. 09.1003.05 16

H.1500 mm.
Art. 09.1003.06 14
Art. 09.1003.07 16



Liscio / Smooth

H.950 mm.
Art. 09.1004 12
Art. 09.1004.01 14
Art. 09.1004.02 16

H.1000 mm.
Art. 09.1004.03 12
Art. 09.1004.04 14
Art. 09.1004.05 16

H.1200 mm.
Art. 09.1004.06 12
Art. 09.1004.07 14
Art. 09.1004.08 16

H.1500 mm.
Art. 09.1004.09 12
Art. 09.1004.10 14
Art. 09.1004.11 16



Liscio / Smooth

H.950 mm.
Art. 09.1005 12
Art. 09.1005.01 14
Art. 09.1005.02 16

H.1000 mm.
Art. 09.1005.03 12
Art. 09.1005.04 14
Art. 09.1005.05 16

H.1200 mm.
Art. 09.1005.06 12
Art. 09.1005.07 14
Art. 09.1005.08 16

H.1500 mm.
Art. 09.1005.09 12
Art. 09.1005.10 14
Art. 09.1005.11 16



Martellato/Hammered

H.950 mm.
Art. 09.1006 12
Art. 09.1006.01 14
Art. 09.1006.02 16

H.1000 mm.
Art. 09.1006.03 12
Art. 09.1006.04 14
Art. 09.1006.05 16

H.1200 mm.
Art. 09.1006.06 12
Art. 09.1006.07 14
Art. 09.1006.08 16

H.1500 mm.
Art. 09.1006.09 12
Art. 09.1006.10 14
Art. 09.1006.11 16



A RICHIESTA CON PALLINA SULLA LANCIA
ON REQUEST WITH BALL ON THE SPEAR



Liscio / Smooth
H.950 mm.
Art. 09.1007 Ø 12
Art. 09.1007.01 Ø 14

H.1000 mm.
Art. 09.1007.02 Ø 12
Art. 09.1007.03 Ø 14

H.1200 mm.
Art. 09.1007.04 Ø 12
Art. 09.1007.05 Ø 14

H.1500 mm.
Art. 09.1007.06 Ø 12
Art. 09.1007.07 Ø 14

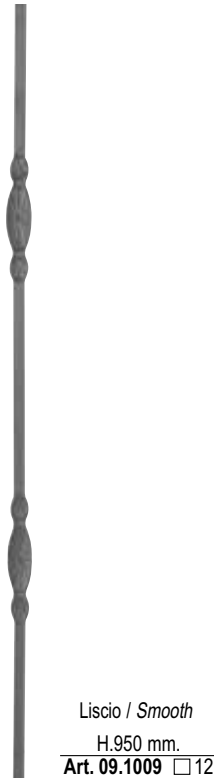
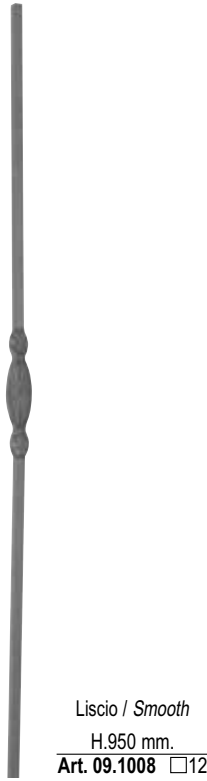

Fuori Produzione
Out of Production

Art. 09.1012

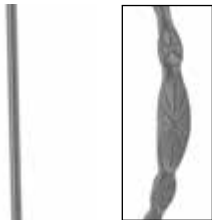

100
o / or
150

Liscio / Smooth
H.950 X L.100 mm.
Art. 09.1013 Ø 12
Art. 09.1013.01 Ø 14
H.950 X L.150 mm.
Art. 09.1013.02 Ø 12
Art. 09.1013.03 Ø 14



100
o / or
150

Martellato / Hammered
H.950 X L.100 mm.
Art. 09.1014 □ 14
H.950 X L.150 mm.
Art. 09.1014.01 □ 14



100
o / or
150

Liscio / Smooth
H.950 X L.100 mm.
Art. 09.1015 □ 14
H.950 X L.150 mm.
Art. 09.1015.01 □ 14

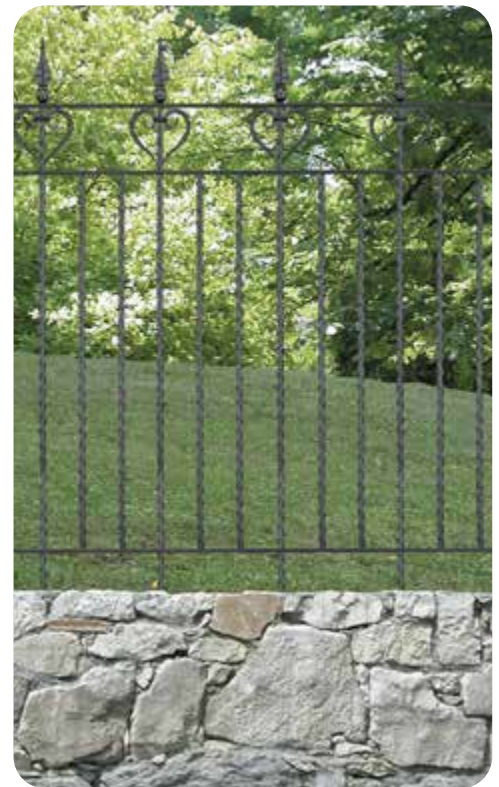

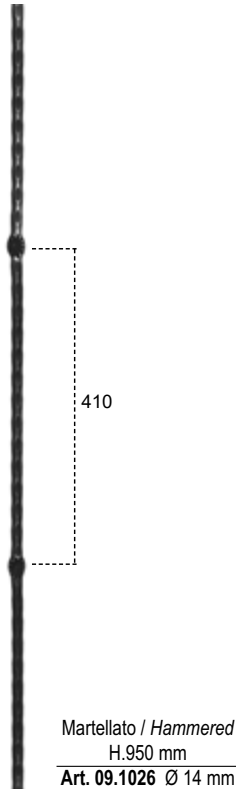
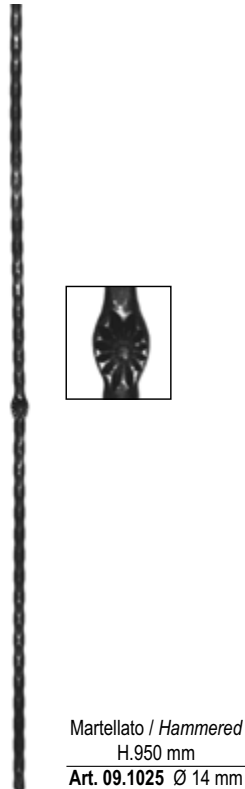
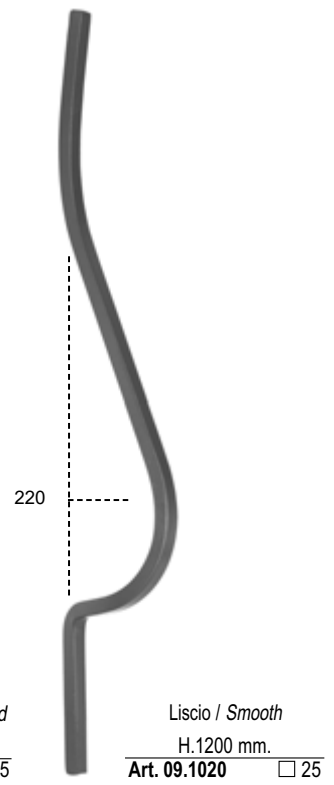
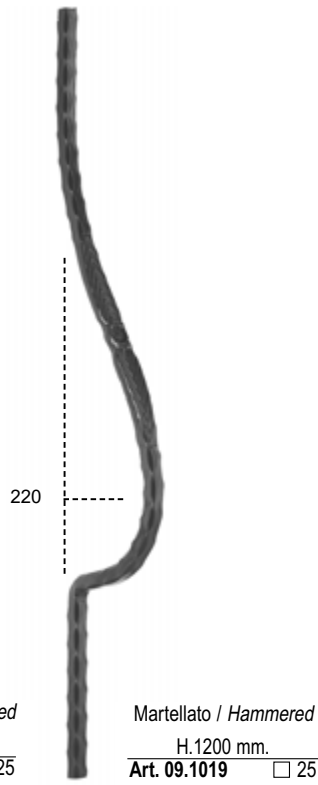
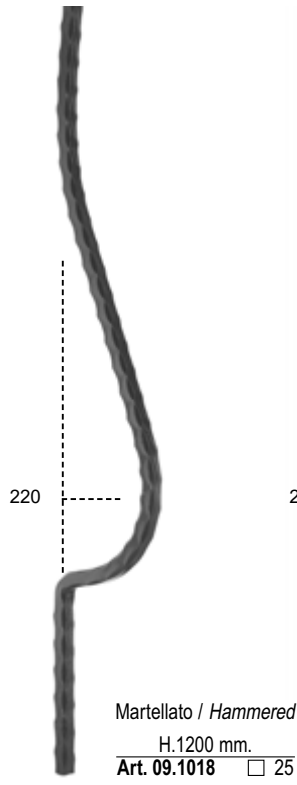
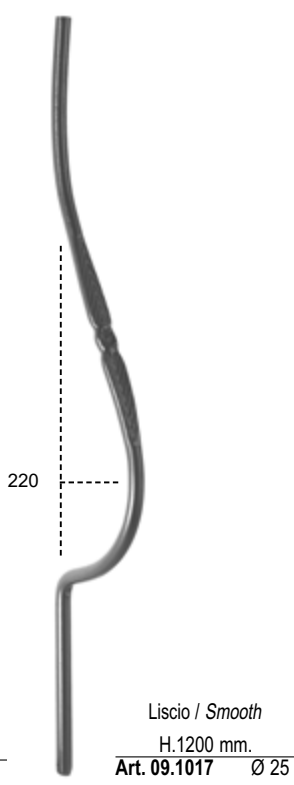
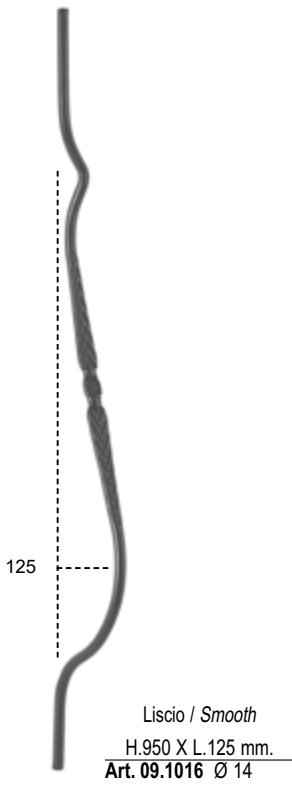



Schiacciata sullo spigolo /
Ornament on the edge
Liscio / Smooth

H 950 mm

Art. 09.1050 12x12 mm
Art. 09.1051 14x14 mm
Art. 09.1052 16x16 mm

H 1000 mm

Art. 09.1053 12x12 mm
Art. 09.1054 14x14 mm
Art. 09.1055 16x16 mm

H 1200 mm

Art. 09.1056 12x12 mm
Art. 09.1057 14x14 mm
Art. 09.1058 16x16 mm



Schiacciata sullo spigolo /
Ornament on the edge
Liscio / Smooth

H 950 mm

Art. 09.1059 12x12 mm
Art. 09.1060 14x14 mm
Art. 09.1061 16x16 mm

H 1000 mm

Art. 09.1062 12x12 mm
Art. 09.1063 14x14 mm
Art. 09.1064 16x16 mm

H 1200 mm

Art. 09.1065 12x12 mm
Art. 09.1066 14x14 mm
Art. 09.1067 16x16 mm



Schiacciata sullo spigolo /
Ornament on the edge
Martellato / Hammered

H 950 mm

Art. 09.1068 12x12 mm
Art. 09.1069 14x14 mm
Art. 09.1070 16x16 mm

H 1000 mm

Art. 09.1071 12x12 mm
Art. 09.1072 14x14 mm
Art. 09.1073 16x16 mm

H 1200 mm

Art. 09.1074 12x12 mm
Art. 09.1075 14x14 mm
Art. 09.1076 16x16 mm



Schiacciata sullo spigolo /
Ornament on the edge
Martellato / Hammered

H 950 mm

Art. 09.1077 12x12 mm
Art. 09.1078 14x14 mm
Art. 09.1079 16x16 mm

H 1000 mm

Art. 09.1080 12x12 mm
Art. 09.1081 14x14 mm
Art. 09.1082 16x16 mm

H 1200 mm

Art. 09.1083 12x12 mm
Art. 09.1084 14x14 mm
Art. 09.1085 16x16 mm



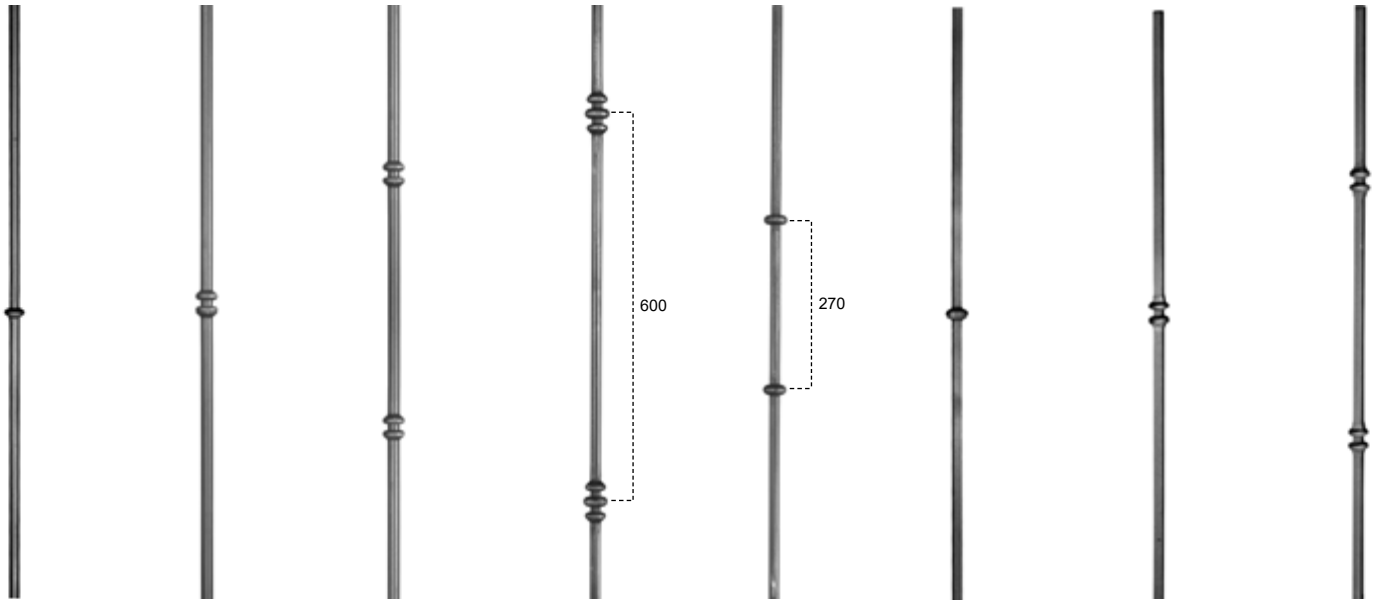

Tondo / Round		Tondo / Round		Tondo / Round		Tondo / Round		Tondo / Round		Tondo / Round		Tondo / Round		Tondo / Round			
H.950 mm.		H.950 mm.		H.950 mm.		H.1500 mm.		H.950 mm.		H.950 mm.		H.950 mm.		H.950 mm.			
Art. 10.001	Ø 16	Art. 10.005	Ø 16	Art. 10.009	Ø 16	Art. 10.012.03	Ø 12	Art. 10.012.09	Ø 12	Art. 10.013	□ 14	Art. 10.017	□ 14	Art. 10.021	□ 14	Art. 10.021.01	□ 16
Art. 10.001.01	Ø 14	Art. 10.005.01	Ø 14	Art. 10.009.01	Ø 14	Art. 10.012.04	Ø 14	Art. 10.012.10	Ø 14	Art. 10.013.01	□ 16	Art. 10.017.01	□ 16	Art. 10.021.01	□ 16	Art. 10.021.01	□ 16
Art. 10.001.02	Ø 12	Art. 10.005.02	Ø 12	Art. 10.009.02	Ø 12	Art. 10.012.05	Ø 16	Art. 10.012.11	Ø 16	Art. 10.013.02	□ 12	Art. 10.017.02	□ 12	Art. 10.021.02	□ 12	Art. 10.021.02	□ 12
H.1000 mm.		H.1000 mm.		H.1000 mm.		H.1800 mm.		H.1000 mm.		H.1000 mm.		H.1000 mm.		H.1000 mm.			
Art. 10.002	Ø 16	Art. 10.006	Ø 16	Art. 10.010	Ø 16	Art. 10.012.06	Ø 12	Art. 10.014	□ 14	Art. 10.018	□ 14	Art. 10.022	□ 14	Art. 10.022	□ 14	Art. 10.022	□ 14
Art. 10.002.01	Ø 14	Art. 10.006.01	Ø 14	Art. 10.010.01	Ø 14	Art. 10.012.07	Ø 14	Art. 10.014.01	□ 16	Art. 10.018.01	□ 16	Art. 10.022.01	□ 16	Art. 10.022.01	□ 16	Art. 10.022.01	□ 16
Art. 10.002.02	Ø 12	Art. 10.006.02	Ø 12	Art. 10.010.02	Ø 12	Art. 10.012.08	Ø 16	Art. 10.014.02	□ 12	Art. 10.018.02	□ 12	Art. 10.022.02	□ 12	Art. 10.022.02	□ 12	Art. 10.022.02	□ 12
H.1200 mm.		H.1200 mm.		H.1200 mm.				H.1200 mm.		H.1200 mm.		H.1200 mm.		H.1200 mm.			
Art. 10.003	Ø 16	Art. 10.007	Ø 16	Art. 10.011	Ø 16			Art. 10.015	□ 14	Art. 10.019	□ 14	Art. 10.023	□ 14	Art. 10.023	□ 14	Art. 10.023	□ 14
Art. 10.003.01	Ø 14	Art. 10.007.01	Ø 14	Art. 10.011.01	Ø 14			Art. 10.015.01	□ 16	Art. 10.019.01	□ 16	Art. 10.023.01	□ 16	Art. 10.023.01	□ 16	Art. 10.023.01	□ 16
Art. 10.003.02	Ø 12	Art. 10.007.02	Ø 12	Art. 10.011.02	Ø 12			Art. 10.015.02	□ 12	Art. 10.019.02	□ 12	Art. 10.023.02	□ 12	Art. 10.023.02	□ 12	Art. 10.023.02	□ 12
H.1500 mm.		H.1500 mm.		H.1500 mm.				H.1500 mm.		H.1500 mm.		H.1500 mm.		H.1500 mm.			
Art. 10.004	Ø 16	Art. 10.008	Ø 16	Art. 10.012	Ø 16			Art. 10.016	□ 14	Art. 10.020	□ 14	Art. 10.024	□ 14	Art. 10.024	□ 14	Art. 10.024	□ 14
Art. 10.004.01	Ø 14	Art. 10.008.01	Ø 14	Art. 10.012.01	Ø 14			Art. 10.016.01	□ 16	Art. 10.020.01	□ 16	Art. 10.024.01	□ 16	Art. 10.024.01	□ 16	Art. 10.024.01	□ 16
Art. 10.004.02	Ø 12	Art. 10.008.02	Ø 12	Art. 10.012.02	Ø 12			Art. 10.016.02	□ 12	Art. 10.020.02	□ 12	Art. 10.024.02	□ 12	Art. 10.024.02	□ 12	Art. 10.024.02	□ 12

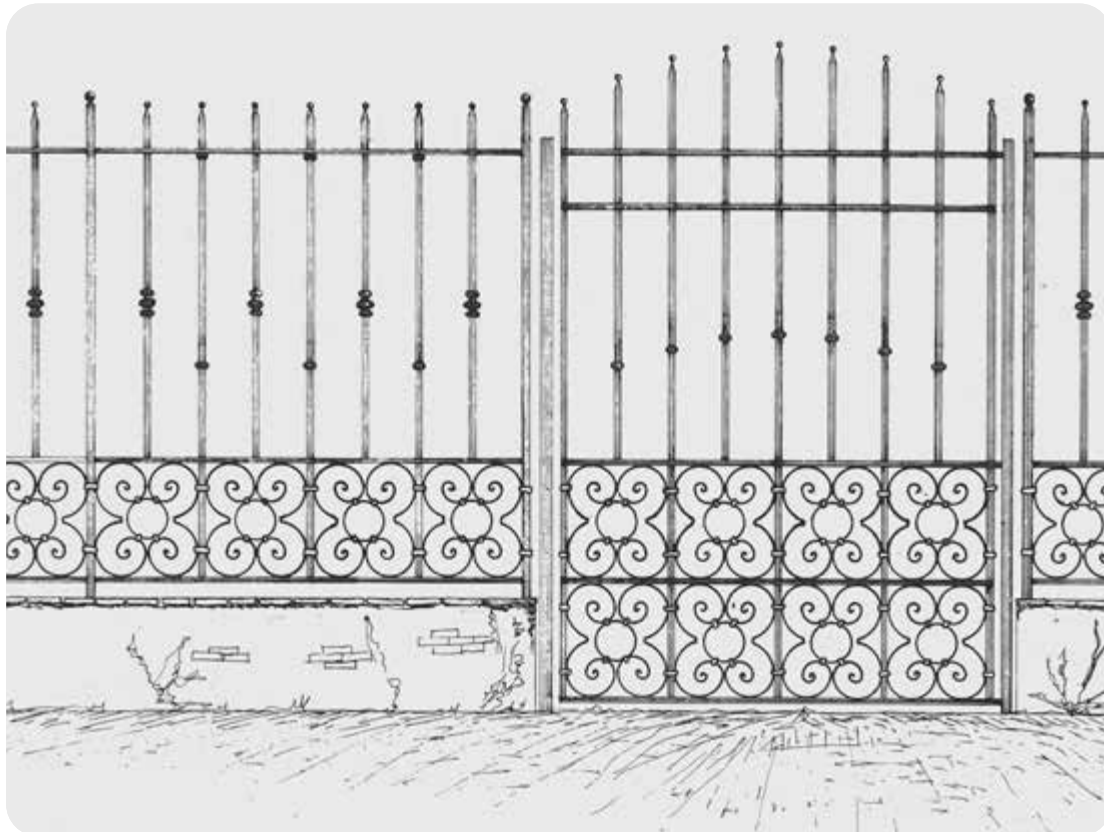

H.1800 mm.	
Art. 10.020.03	□ 14
Art. 10.020.04	□ 16
H.2000 mm.	
Art. 10.020.05	□ 14
Art. 10.020.06	□ 16

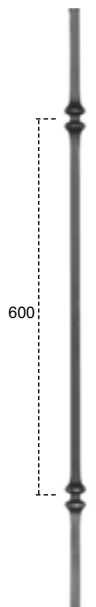

H.1500 mm.	
Art. 10.024.03	□ 14
Art. 10.024.04	□ 16
H.1800 mm.	
Art. 10.024.05	□ 14
Art. 10.024.06	□ 16
H.2000 mm.	
Art. 10.024.07	□ 14
Art. 10.024.08	□ 16

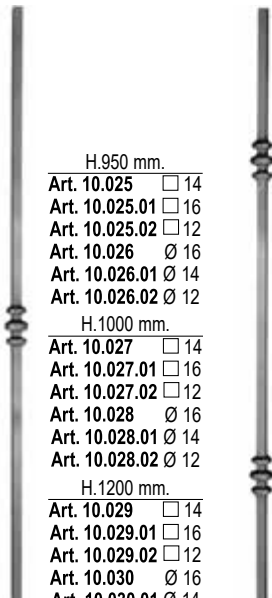

- H.950 mm.
Art. 10.025 14
Art. 10.025.01 16
Art. 10.025.02 12
Art. 10.026 \varnothing 16
Art. 10.026.01 \varnothing 14
Art. 10.026.02 \varnothing 12
- H.1000 mm.
Art. 10.027 14
Art. 10.027.01 16
Art. 10.027.02 12
Art. 10.028 \varnothing 16
Art. 10.028.01 \varnothing 14
Art. 10.028.02 \varnothing 12
- H.1200 mm.
Art. 10.029 14
Art. 10.029.01 16
Art. 10.029.02 12
Art. 10.030 \varnothing 16
Art. 10.030.01 \varnothing 14
Art. 10.030.02 \varnothing 12
- H.1500 mm.
Art. 10.031 14
Art. 10.031.01 16
Art. 10.031.02 12
Art. 10.032 \varnothing 16
Art. 10.032.01 \varnothing 14
Art. 10.032.02 \varnothing 12

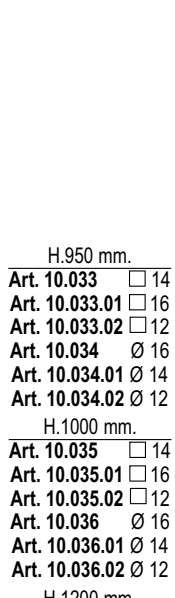

- H.950 mm.
Art. 10.033 14
Art. 10.033.01 16
Art. 10.033.02 12
Art. 10.034 \varnothing 16
Art. 10.034.01 \varnothing 14
Art. 10.034.02 \varnothing 12
- H.1000 mm.
Art. 10.035 14
Art. 10.035.01 16
Art. 10.035.02 12
Art. 10.036 \varnothing 16
Art. 10.036.01 \varnothing 14
Art. 10.036.02 \varnothing 12
- H.1200 mm.
Art. 10.037 14
Art. 10.037.01 16
Art. 10.037.02 12
Art. 10.038 \varnothing 16
Art. 10.038.01 \varnothing 14
Art. 10.038.02 \varnothing 12
- H.1500 mm.
Art. 10.039 14
Art. 10.039.01 16
Art. 10.039.02 12
Art. 10.040 \varnothing 16
Art. 10.040.01 \varnothing 14
Art. 10.040.02 \varnothing 12

H.2500 mm.
Art. 10.032.20 14 **NEW**



- Martellato / Hammered
H.950 mm.
Art. 10.040.03 12
Art. 10.040.04 14
Art. 10.040.05 16
- H.1000 mm.
Art. 10.040.06 12
Art. 10.040.07 14
Art. 10.040.08 16
- H.1200 mm.
Art. 10.040.09 12
Art. 10.040.10 14
Art. 10.040.11 16
- H.1500 mm.
Art. 10.040.12 12
Art. 10.040.13 14
Art. 10.040.14 16



- Martellato / Hammered
H.950 mm.
Art. 10.040.15 12
Art. 10.040.16 14
Art. 10.040.17 16
- H.1000 mm.
Art. 10.040.18 12
Art. 10.040.19 14
Art. 10.040.20 16
- H.1200 mm.
Art. 10.040.21 12
Art. 10.040.22 14
Art. 10.040.23 16
- H.1500 mm.
Art. 10.040.24 12
Art. 10.040.25 14
Art. 10.040.26 16



- Martellato / Hammered
H.950 mm.
Art. 10.041 14
Art. 10.041.01 16
Art. 10.041.02 12
- H.1000 mm.
Art. 10.042 14
Art. 10.042.01 16
Art. 10.042.02 12
- H.1200 mm.
Art. 10.043 14
Art. 10.043.01 16
Art. 10.043.02 12
- H.1500 mm.
Art. 10.044 14
Art. 10.044.01 16
Art. 10.044.02 12



- Martellato / Hammered
H.950 mm.
Art. 10.045 14
Art. 10.045.01 16
Art. 10.045.02 12
- H.1000 mm.
Art. 10.046 14
Art. 10.046.01 16
Art. 10.046.02 12
- H.1200 mm.
Art. 10.047 14
Art. 10.047.01 16
Art. 10.047.02 12
- H.1500 mm.
Art. 10.048 14
Art. 10.048.01 16
Art. 10.048.02 12



Paletti ricalcati - Tendenze Odierne / New forged bars - Modern Design

Martellato/Hammered
H.950 mm.
Art. 09.658 12
Art. 09.659 14

Martellato/Hammered
H.950 mm.
Art. 09.660 12
Art. 09.661 14

H.950 mm.
Art. 09.662 12
Art. 09.663 14

H.950 mm.
Art. 09.664 12
Art. 09.665 14

Tutte le parti di questo catalogo - foto comprese - sono di proprietà Euro-Fer. La riproduzione, anche parziale, è vietata in ogni forma e con ogni mezzo. / Every part of this catalogue - photos included - is Euro-Fer's property. All forms of copying are strictly prohibited.

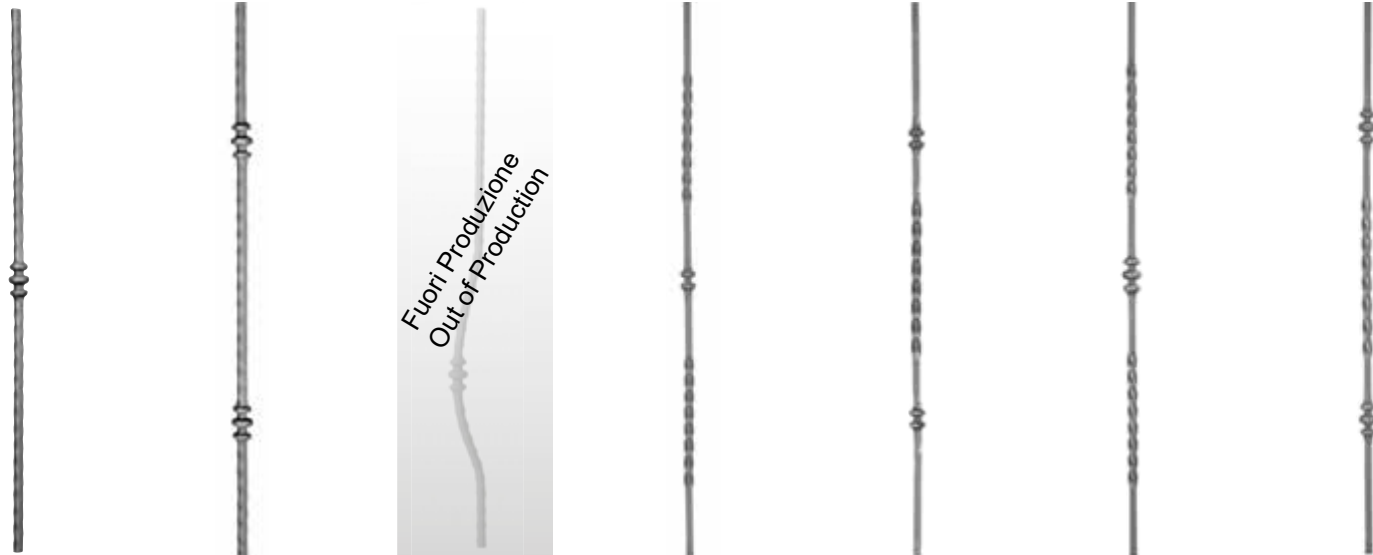

Martellato/Hammered

H.950 mm.

- Art. 10.049 14
 Art. 10.049.01 16
 Art. 10.049.02 12

H.1000 mm.

- Art. 10.050 14
 Art. 10.050.01 16
 Art. 10.050.02 12

H.1200 mm.

- Art. 10.051 14
 Art. 10.051.01 16
 Art. 10.051.02 12

H.1500 mm.

- Art. 10.052 14
 Art. 10.052.01 16
 Art. 10.052.02 12

H.1800 mm.

- Art. 10.052.03 12
 Art. 10.052.04 14
 Art. 10.052.05 16

H.2000 mm.

- Art. 10.052.06 12
 Art. 10.052.07 14
 Art. 10.052.08 16

Martellato/Hammered

H.950 mm.

- Art. 10.053 14
 Art. 10.053.01 16
 Art. 10.053.02 12

H.1000 mm.

- Art. 10.054 14
 Art. 10.054.01 16
 Art. 10.054.02 12

H.1200 mm.

- Art. 10.055 14
 Art. 10.055.01 16
 Art. 10.055.02 12

H.1500 mm.

- Art. 10.056 14
 Art. 10.056.01 16
 Art. 10.056.02 12

Fuori Produzione
Out of Production

- Art. 10.056.03
 Art. 10.056.04
 Art. 10.056.05

- Art. 10.056.06
 Art. 10.056.07
 Art. 10.056.08

- Art. 10.056.09
 Art. 10.056.10
 Art. 10.056.11

- Art. 10.056.12
 Art. 10.056.13
 Art. 10.056.14

H.950 mm.

- Art. 10.056.15 12
 Art. 10.056.16 14
 Art. 10.056.17 16

H.1000 mm.

- Art. 10.056.18 12
 Art. 10.056.19 14
 Art. 10.056.20 16

H.1200 mm.

- Art. 10.056.21 12
 Art. 10.056.22 14
 Art. 10.056.23 16

H.1500 mm.

- Art. 10.056.24 12
 Art. 10.056.25 14
 Art. 10.056.26 16

H.950 mm.

- Art. 10.056.27 12
 Art. 10.056.28 14
 Art. 10.056.29 16

H.1000 mm.

- Art. 10.056.30 12
 Art. 10.056.31 14
 Art. 10.056.32 16

H.1200 mm.

- Art. 10.056.33 12
 Art. 10.056.34 14
 Art. 10.056.35 16

H.1500 mm.

- Art. 10.056.36 12
 Art. 10.056.37 14
 Art. 10.056.38 16

H.950 mm.

- Art. 10.056.39 12
 Art. 10.056.40 14
 Art. 10.056.41 16

H.1000 mm.

- Art. 10.056.42 12
 Art. 10.056.43 14
 Art. 10.056.44 16

H.1200 mm.

- Art. 10.056.45 12
 Art. 10.056.46 14
 Art. 10.056.47 16

H.1500 mm.

- Art. 10.056.48 12
 Art. 10.056.49 14
 Art. 10.056.50 16

H.950 mm.

- Art. 10.056.51 12
 Art. 10.056.52 14
 Art. 10.056.53 16

H.1000 mm.

- Art. 10.056.54 12
 Art. 10.056.55 14
 Art. 10.056.56 16

H.1200 mm.

- Art. 10.056.57 12
 Art. 10.056.58 14
 Art. 10.056.59 16

H.1500 mm.

- Art. 10.056.60 12
 Art. 10.056.61 14
 Art. 10.056.62 16

PALLINE GRANDI / LARGE BALLS

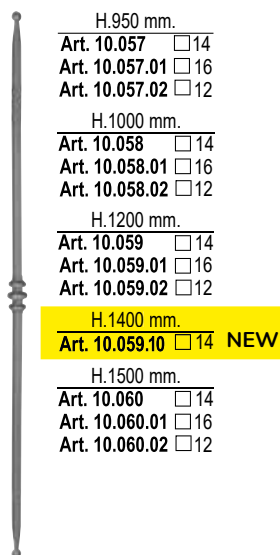

H.950 mm.

- Art. 10.057 14
 Art. 10.057.01 16
 Art. 10.057.02 12

H.1000 mm.

- Art. 10.058 14
 Art. 10.058.01 16
 Art. 10.058.02 12

H.1200 mm.

- Art. 10.059 14
 Art. 10.059.01 16
 Art. 10.059.02 12

H.1400 mm.

- Art. 10.059.10 14 **NEW**

H.1500 mm.

- Art. 10.060 14
 Art. 10.060.01 16
 Art. 10.060.02 12

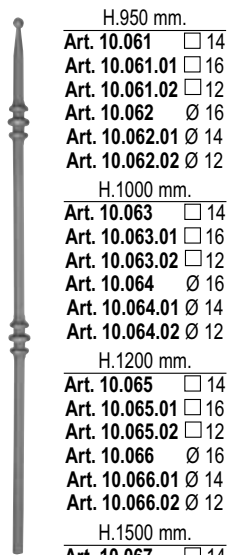

H.950 mm.

- Art. 10.061 14
 Art. 10.061.01 16
 Art. 10.061.02 12

H.1000 mm.

- Art. 10.062 16
 Art. 10.062.01 14
 Art. 10.062.02 12

H.1200 mm.

- Art. 10.063 14
 Art. 10.063.01 16
 Art. 10.063.02 12

H.1500 mm.

- Art. 10.065 14
 Art. 10.065.01 16
 Art. 10.065.02 12

- Art. 10.066 16
 Art. 10.066.01 14
 Art. 10.066.02 12

- Art. 10.067 14
 Art. 10.067.01 16
 Art. 10.067.02 12

- Art. 10.068 16
 Art. 10.068.01 14
 Art. 10.068.02 12

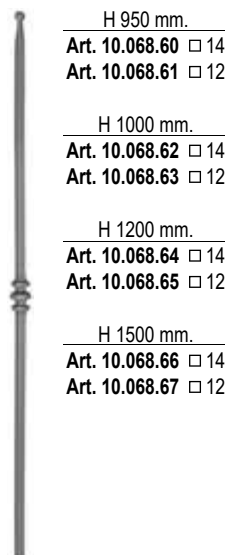

H.950 mm.

- Art. 10.068.60 14
 Art. 10.068.61 12

H.1000 mm.

- Art. 10.068.62 14
 Art. 10.068.63 12

H.1200 mm.

- Art. 10.068.64 14
 Art. 10.068.65 12

H.1500 mm.

- Art. 10.068.66 14
 Art. 10.068.67 12

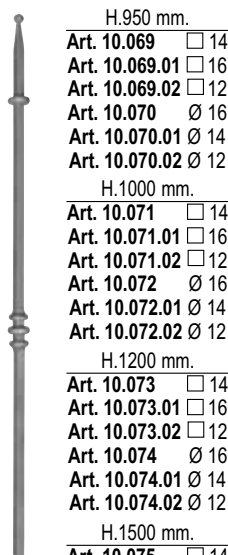

H.950 mm.

- Art. 10.069 14
 Art. 10.069.01 16
 Art. 10.069.02 12

H.1000 mm.

- Art. 10.070 16
 Art. 10.070.01 14
 Art. 10.070.02 12

H.1200 mm.

- Art. 10.071 14
 Art. 10.071.01 16
 Art. 10.071.02 12

H.1500 mm.

- Art. 10.073 14
 Art. 10.073.01 16
 Art. 10.073.02 12

- Art. 10.074 16
 Art. 10.074.01 14
 Art. 10.074.02 12

- Art. 10.075 14
 Art. 10.075.01 16
 Art. 10.075.02 12

- Art. 10.076 16
 Art. 10.076.01 14
 Art. 10.076.02 12

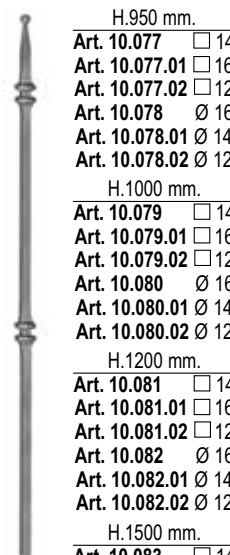

H.950 mm.

- Art. 10.077 14
 Art. 10.077.01 16
 Art. 10.077.02 12

H.1000 mm.

- Art. 10.078 16
 Art. 10.078.01 14
 Art. 10.078.02 12

H.1200 mm.

- Art. 10.079 14
 Art. 10.079.01 16
 Art. 10.079.02 12

H.1500 mm.

- Art. 10.080 16
 Art. 10.080.01 14
 Art. 10.080.02 12

- Art. 10.081 14
 Art. 10.081.01 16
 Art. 10.081.02 12

- Art. 10.082 16
 Art. 10.082.01 14
 Art. 10.082.02 12

- Art. 10.083 14
 Art. 10.083.01 16
 Art. 10.083.02 12













- Art. 10.084 16
 Art. 10.084.01 14
 Art. 10.084.02 12

ELEMENTI IN FERRO RICALCATO NEW FORGED BARS

10

PALLINE GRANDI / LARGE BALLS

NEW

						
H.950 mm. Art. 10.085 □ 14 Art. 10.085.01 □ 16 Art. 10.085.02 □ 12 Art. 10.086 Ø 16 Art. 10.086.01 Ø 14 Art. 10.086.02 Ø 12	H.950 mm. Art. 10.093 □ 14 Art. 10.093.01 □ 16 Art. 10.093.02 □ 12 Art. 10.094 Ø 16 Art. 10.094.01 Ø 14 Art. 10.094.02 Ø 12	H.950 mm. Art. 10.101 □ 14 Art. 10.101.01 □ 16 Art. 10.101.02 □ 12 Art. 10.102 Ø 16 Art. 10.102.01 Ø 14 Art. 10.102.02 Ø 12	H.950 mm. Art. 10.108.60 □ 14 Art. 10.108.61 □ 16 Art. 10.108.62 □ 12 Art. 10.108.63 Ø 16 Art. 10.108.64 Ø 14 Art. 10.108.65 Ø 12	H.1000 mm. Art. 10.108.106 □ 14 Art. 10.108.108 □ 12	H.950 mm. Art. 10.109 □ 14 Art. 10.109.01 □ 16 Art. 10.109.02 □ 12 Art. 10.110 Ø 16 Art. 10.110.01 Ø 14 Art. 10.110.02 Ø 12	H.950 mm. Art. 10.117 □ 14 Art. 10.117.01 □ 16 Art. 10.117.02 □ 12 Art. 10.118 Ø 16 Art. 10.118.01 Ø 14 Art. 10.118.02 Ø 12
H.1000 mm. Art. 10.087 □ 14 Art. 10.087.01 □ 16 Art. 10.087.02 □ 12 Art. 10.088 Ø 16 Art. 10.088.01 Ø 14 Art. 10.088.02 Ø 12	H.1000 mm. Art. 10.095 □ 14 Art. 10.095.01 □ 16 Art. 10.095.02 □ 12 Art. 10.096 Ø 16 Art. 10.096.01 Ø 14 Art. 10.096.02 Ø 12	H.1000 mm. Art. 10.103 □ 14 Art. 10.103.01 □ 16 Art. 10.103.02 □ 12 Art. 10.104 Ø 16 Art. 10.104.01 Ø 14 Art. 10.104.02 Ø 12	H.1000 mm. Art. 10.108.66 □ 14 Art. 10.108.67 □ 16 Art. 10.108.68 □ 12 Art. 10.108.69 Ø 16 Art. 10.108.70 Ø 14 Art. 10.108.71 Ø 12	H.1000 mm. Art. 10.108.72 □ 14 Art. 10.108.73 □ 16 Art. 10.108.74 □ 12 Art. 10.108.75 Ø 16 Art. 10.108.76 Ø 14 Art. 10.108.77 Ø 12	H.1000 mm. Art. 10.111 □ 14 Art. 10.111.01 □ 16 Art. 10.111.02 □ 12 Art. 10.112 Ø 16 Art. 10.112.01 Ø 14 Art. 10.112.02 Ø 12	H.1000 mm. Art. 10.119 □ 14 Art. 10.119.01 □ 16 Art. 10.119.02 □ 12 Art. 10.120 Ø 16 Art. 10.120.01 Ø 14 Art. 10.120.02 Ø 12
H.1200 mm. Art. 10.089 □ 14 Art. 10.089.01 □ 16 Art. 10.089.02 □ 12 Art. 10.090 Ø 16 Art. 10.090.01 Ø 14 Art. 10.090.02 Ø 12	H.1200 mm. Art. 10.097 □ 14 Art. 10.097.01 □ 16 Art. 10.097.02 □ 12 Art. 10.098 Ø 16 Art. 10.098.01 Ø 14 Art. 10.098.02 Ø 12	H.1200 mm. Art. 10.105 □ 14 Art. 10.105.01 □ 16 Art. 10.105.02 □ 12 Art. 10.106 Ø 16 Art. 10.106.01 Ø 14 Art. 10.106.02 Ø 12	H.1200 mm. Art. 10.108.72 □ 14 Art. 10.108.73 □ 16 Art. 10.108.74 □ 12 Art. 10.108.75 Ø 16 Art. 10.108.76 Ø 14 Art. 10.108.77 Ø 12	H.1200 mm. Art. 10.108.78 □ 14 Art. 10.108.79 □ 16 Art. 10.108.80 □ 12 Art. 10.108.81 Ø 16 Art. 10.108.82 Ø 14 Art. 10.108.83 Ø 12	H.1200 mm. Art. 10.113 □ 14 Art. 10.113.01 □ 16 Art. 10.113.02 □ 12 Art. 10.114 Ø 16 Art. 10.114.01 Ø 14 Art. 10.114.02 Ø 12	H.1200 mm. Art. 10.121 □ 14 Art. 10.121.01 □ 16 Art. 10.121.02 □ 12 Art. 10.122 Ø 16 Art. 10.122.01 Ø 14 Art. 10.122.02 Ø 12
H.1500 mm. Art. 10.091 □ 14 Art. 10.091.01 □ 16 Art. 10.091.02 □ 12 Art. 10.092 Ø 16 Art. 10.092.01 Ø 14 Art. 10.092.02 Ø 12	H.1500 mm. Art. 10.099 □ 14 Art. 10.099.01 □ 16 Art. 10.099.02 □ 12 Art. 10.100 Ø 16 Art. 10.100.01 Ø 14 Art. 10.100.02 Ø 12	H.1500 mm. Art. 10.107 □ 14 Art. 10.107.01 □ 16 Art. 10.107.02 □ 12 Art. 10.108 Ø 16 Art. 10.108.01 Ø 14 Art. 10.108.02 Ø 12	H.1500 mm. Art. 10.108.78 □ 14 Art. 10.108.79 □ 16 Art. 10.108.80 □ 12 Art. 10.108.81 Ø 16 Art. 10.108.82 Ø 14 Art. 10.108.83 Ø 12	H.1500 mm. Art. 10.108.78 □ 14 Art. 10.108.79 □ 16 Art. 10.108.80 □ 12 Art. 10.108.81 Ø 16 Art. 10.108.82 Ø 14 Art. 10.108.83 Ø 12	H.1500 mm. Art. 10.115 □ 14 Art. 10.115.01 □ 16 Art. 10.115.02 □ 12 Art. 10.116 Ø 16 Art. 10.116.01 Ø 14 Art. 10.116.02 Ø 12	H.1500 mm. Art. 10.123 □ 14 Art. 10.123.01 □ 16 Art. 10.123.02 □ 12 Art. 10.124 Ø 16 Art. 10.124.01 Ø 14 Art. 10.124.02 Ø 12
						
H.950 mm. Art. 10.125 □ 14 Art. 10.125.01 □ 16 Art. 10.125.02 □ 12 Art. 10.126 Ø 16 Art. 10.126.01 Ø 14 Art. 10.126.02 Ø 12	H.950 mm. Art. 10.133 □ 14 Art. 10.133.01 □ 16 Art. 10.133.02 □ 12 Art. 10.134 Ø 16 Art. 10.134.01 Ø 14 Art. 10.134.02 Ø 12	H.950 mm. Art. 10.141 □ 14 Art. 10.141.01 □ 16 Art. 10.141.02 □ 12 Art. 10.142 Ø 16 Art. 10.142.01 Ø 14 Art. 10.142.02 Ø 12	H.950 mm. Art. 10.141 □ 14 Art. 10.141.01 □ 16 Art. 10.141.02 □ 12 Art. 10.142 Ø 16 Art. 10.142.01 Ø 14 Art. 10.142.02 Ø 12	H.950 mm. Art. 10.141 □ 14 Art. 10.141.01 □ 16 Art. 10.141.02 □ 12 Art. 10.142 Ø 16 Art. 10.142.01 Ø 14 Art. 10.142.02 Ø 12		
H.1000 mm. Art. 10.127 □ 14 Art. 10.127.01 □ 16 Art. 10.127.02 □ 12 Art. 10.128 Ø 16 Art. 10.128.01 Ø 14 Art. 10.128.02 Ø 12	H.1000 mm. Art. 10.135 □ 14 Art. 10.135.01 □ 16 Art. 10.135.02 □ 12 Art. 10.136 Ø 16 Art. 10.136.01 Ø 14 Art. 10.136.02 Ø 12	H.1000 mm. Art. 10.143 □ 14 Art. 10.143.01 □ 16 Art. 10.143.02 □ 12 Art. 10.144 Ø 16 Art. 10.144.01 Ø 14 Art. 10.144.02 Ø 12	H.1000 mm. Art. 10.143 □ 14 Art. 10.143.01 □ 16 Art. 10.143.02 □ 12 Art. 10.144 Ø 16 Art. 10.144.01 Ø 14 Art. 10.144.02 Ø 12	H.1000 mm. Art. 10.143 □ 14 Art. 10.143.01 □ 16 Art. 10.143.02 □ 12 Art. 10.144 Ø 16 Art. 10.144.01 Ø 14 Art. 10.144.02 Ø 12		
H.1200 mm. Art. 10.129 □ 14 Art. 10.129.01 □ 16 Art. 10.129.02 □ 12 Art. 10.130 Ø 16 Art. 10.130.01 Ø 14 Art. 10.130.02 Ø 12	H.1200 mm. Art. 10.137 □ 14 Art. 10.137.01 □ 16 Art. 10.137.02 □ 12 Art. 10.138 Ø 16 Art. 10.138.01 Ø 14 Art. 10.138.02 Ø 12	H.1200 mm. Art. 10.145 □ 14 Art. 10.145.01 □ 16 Art. 10.145.02 □ 12 Art. 10.146 Ø 16 Art. 10.146.01 Ø 14 Art. 10.146.02 Ø 12	H.1200 mm. Art. 10.145 □ 14 Art. 10.145.01 □ 16 Art. 10.145.02 □ 12 Art. 10.146 Ø 16 Art. 10.146.01 Ø 14 Art. 10.146.02 Ø 12	H.1200 mm. Art. 10.145 □ 14 Art. 10.145.01 □ 16 Art. 10.145.02 □ 12 Art. 10.146 Ø 16 Art. 10.146.01 Ø 14 Art. 10.146.02 Ø 12		
H.1500 mm. Art. 10.131 □ 14 Art. 10.131.01 □ 16 Art. 10.131.02 □ 12 Art. 10.132 Ø 16 Art. 10.132.01 Ø 14 Art. 10.132.02 Ø 12	H.1500 mm. Art. 10.139 □ 14 Art. 10.139.01 □ 16 Art. 10.139.02 □ 12 Art. 10.140 Ø 16 Art. 10.140.01 Ø 14 Art. 10.140.02 Ø 12	H.1500 mm. Art. 10.147 □ 14 Art. 10.147.01 □ 16 Art. 10.147.02 □ 12 Art. 10.148 Ø 16 Art. 10.148.01 Ø 14 Art. 10.148.02 Ø 12	H.1500 mm. Art. 10.147 □ 14 Art. 10.147.01 □ 16 Art. 10.147.02 □ 12 Art. 10.148 Ø 16 Art. 10.148.01 Ø 14 Art. 10.148.02 Ø 12	H.1500 mm. Art. 10.147 □ 14 Art. 10.147.01 □ 16 Art. 10.147.02 □ 12 Art. 10.148 Ø 16 Art. 10.148.01 Ø 14 Art. 10.148.02 Ø 12		
					Martellato Hammered	
					H.950 mm. Art. 10.148.03 □ 12 Art. 10.148.04 □ 14 Art. 10.148.05 □ 16	H.950 mm. Art. 10.148.50 □ 12 Art. 10.148.51 □ 14 Art. 10.148.52 □ 16
					H.1000 mm. Art. 10.148.06 □ 12 Art. 10.148.07 □ 14 Art. 10.148.08 □ 16	H.1000 mm. Art. 10.148.53 □ 12 Art. 10.148.54 □ 14 Art. 10.148.55 □ 16
					H.1200 mm. Art. 10.148.09 □ 12 Art. 10.148.10 □ 14 Art. 10.148.11 □ 16	H.1200 mm. Art. 10.148.56 □ 12 Art. 10.148.57 □ 14 Art. 10.148.58 □ 16
					H.1500 mm. Art. 10.148.12 □ 12 Art. 10.148.13 □ 14 Art. 10.148.14 □ 16	H.1500 mm. Art. 10.148.59 □ 12 Art. 10.148.60 □ 14 Art. 10.148.61 □ 16

Tutte le parti di questo catalogo - foto comprese - sono di proprietà Euro-Fer. La riproduzione, anche parziale, è vietata in ogni forma e con ogni mezzo. / Every part of this catalogue - photos included - is Euro-Fer's property. All forms of copying are strictly prohibited.

from art. 10.085 to art. 10.148.61

EUROFER

165

NEW

PALLINE PICCOLE / SMALL BALLS

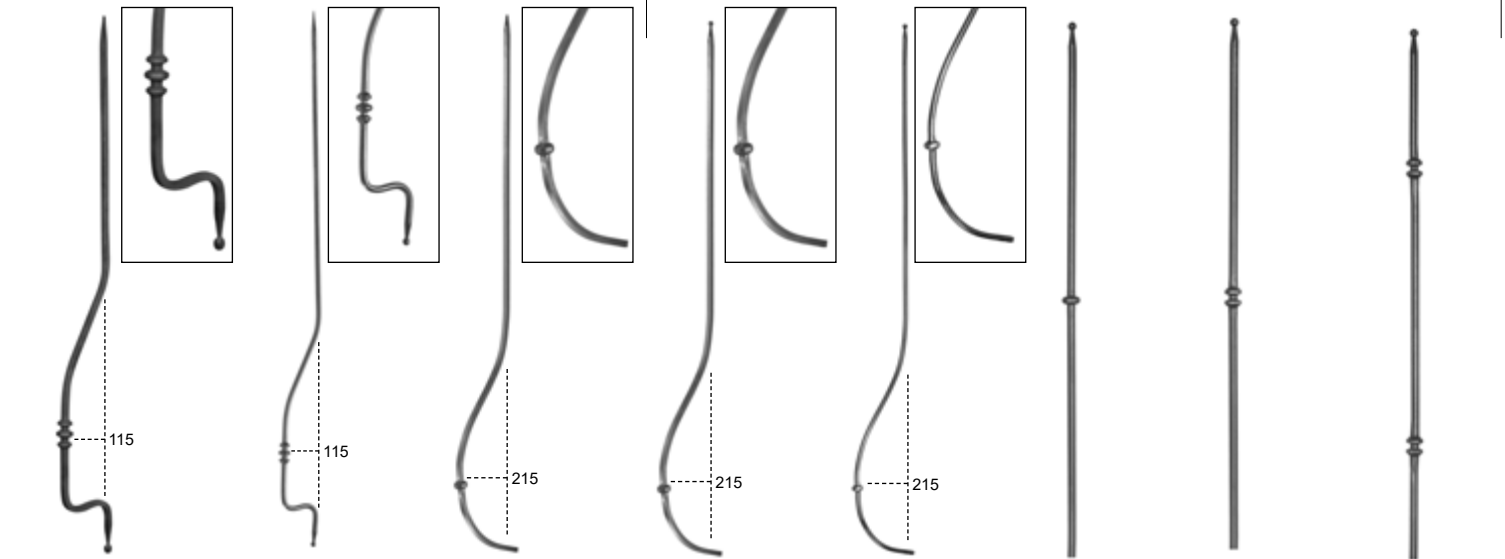

Tondo / Round		Tondo / Round		Tondo / Round		Tondo / Round		Tondo / Round		Tondo / Round							
H.950 mm.		H.950 mm.		H.1000 mm.		H.1000 mm.		H.1000 mm.		H.950 mm.							
Art. 10.149	□14	Art. 10.152.03	Ø 14	Art. 10.152.41	□12	Art. 10.152.11	□12	Art. 10.152.23	Ø 14	Art. 10.153	Ø 12	Art. 10.165	Ø 12				
Art. 10.149.01	□16	Art. 10.152.04	Ø 16	Art. 10.152.42	□14	Art. 10.152.12	□14	Art. 10.152.24	Ø 16	Art. 10.154	Ø 14	Art. 10.166	Ø 14	Art. 10.177	Ø 14		
Art. 10.149.02	□12					Art. 10.152.13	□16			Art. 10.155	Ø 16	Art. 10.167	Ø 16	Art. 10.179	Ø 16		
H.1000 mm.		H.1200 mm.		H.1600 mm.		H.1200 mm.		H.1200 mm.		H.1000 mm.		H.1000 mm.		H.1000 mm.			
Art. 10.150	□14	Art. 10.152.05	Ø 14	Art. 10.152.55	□14	Art. 10.152.14	□12	Art. 10.152.25	Ø 14	Art. 10.156	Ø 12	Art. 10.168	Ø 12	Art. 10.180	Ø 12	Art. 10.180	Ø 12
Art. 10.150.01	□16	Art. 10.152.06	Ø 16			Art. 10.152.15	□14	Art. 10.152.26	Ø 16	Art. 10.157	Ø 14	Art. 10.169	Ø 14	Art. 10.181	Ø 14	Art. 10.181	Ø 14
Art. 10.150.02	□12			H.1700 mm.		Art. 10.152.16	□16	Art. 10.152.27	Ø 14	Art. 10.158	Ø 16	Art. 10.170	Ø 16	Art. 10.182	Ø 16	Art. 10.182	Ø 16
H.1200 mm.		H.1500 mm.		H.1800 mm.		H.1500 mm.		H.1500 mm.		H.1200 mm.		H.1200 mm.		H.1200 mm.			
Art. 10.151	□14	Art. 10.152.07	Ø 14	Art. 10.152.56	□14	Art. 10.152.17	□12	Art. 10.152.28	Ø 16	Art. 10.159	Ø 12	Art. 10.171	Ø 12	Art. 10.183	Ø 12	Art. 10.183	Ø 12
Art. 10.151.01	□16	Art. 10.152.08	Ø 16			Art. 10.152.18	□14	Art. 10.152.29	Ø 14	Art. 10.160	Ø 14	Art. 10.172	Ø 14	Art. 10.184	Ø 14	Art. 10.184	Ø 14
Art. 10.151.02	□12	Art. 10.152.09	Ø 14	Art. 10.152.57	□14	Art. 10.152.19	□16	Art. 10.152.30	Ø 16	Art. 10.161	Ø 16	Art. 10.173	Ø 16	Art. 10.185	Ø 16	Art. 10.185	Ø 16
H.1500 mm.		H.1800 mm.				H.1800 mm.		H.1800 mm.		H.1500 mm.		H.1500 mm.		H.1500 mm.			
Art. 10.152	□14	Art. 10.152.10	Ø 16			Art. 10.152.20	□12			Art. 10.162	Ø 12	Art. 10.174	Ø 12	Art. 10.186	Ø 12	Art. 10.186	Ø 12
Art. 10.152.01	□16					Art. 10.152.21	□14			Art. 10.163	Ø 14	Art. 10.175	Ø 14	Art. 10.187	Ø 14	Art. 10.187	Ø 14
Art. 10.152.02	□12					Art. 10.152.22	□16			Art. 10.164	Ø 16	Art. 10.176	Ø 16	Art. 10.188	Ø 16	Art. 10.188	Ø 16

PALLINE PICCOLE / SMALL BALLS

Tondo / Round		Tondo / Round		Tondo / Round		Tondo / Round		Tondo / Round		Tondo / Round		Tondo / Round			
H.950 mm.		H.950 mm.		H.950 mm.		H.950 mm.		H.950 mm.		H.950 mm.		H.950 mm.			
Art. 10.189	Ø 12	Art. 10.201	Ø 12	Art. 10.213	□12	Art. 10.225	□12	Art. 10.237	□12	Art. 10.249	□12	Art. 10.261	□12	Art. 10.261	□12
Art. 10.190	Ø 14	Art. 10.202	Ø 14	Art. 10.214	□14	Art. 10.226	□14	Art. 10.238	□14	Art. 10.250	□14	Art. 10.262	□14	Art. 10.262	□14
Art. 10.191	Ø 16	Art. 10.203	Ø 16	Art. 10.215	□16	Art. 10.227	□16	Art. 10.239	□16	Art. 10.251	□16	Art. 10.263	□16	Art. 10.263	□16
H.1000 mm.		H.1000 mm.		H.1000 mm.		H.1000 mm.		H.1000 mm.		H.1000 mm.		H.1000 mm.			
Art. 10.192	Ø 12	Art. 10.204	Ø 12	Art. 10.216	□12	Art. 10.228	□12	Art. 10.240	□12	Art. 10.252	□12	Art. 10.264	□12	Art. 10.264	□12
Art. 10.193	Ø 14	Art. 10.205	Ø 14	Art. 10.217	□14	Art. 10.229	□14	Art. 10.241	□14	Art. 10.253	□14	Art. 10.265	□14	Art. 10.265	□14
Art. 10.194	Ø 16	Art. 10.206	Ø 16	Art. 10.218	□16	Art. 10.230	□16	Art. 10.242	□16	Art. 10.254	□16	Art. 10.266	□16	Art. 10.266	□16
H.1200 mm.		H.1200 mm.		H.1200 mm.		H.1200 mm.		H.1200 mm.		H.1200 mm.		H.1200 mm.			
Art. 10.195	Ø 12	Art. 10.207	Ø 12	Art. 10.219	□12	Art. 10.231	□12	Art. 10.243	□12	Art. 10.255	□12	Art. 10.267	□12	Art. 10.267	□12
Art. 10.196	Ø 14	Art. 10.208	Ø 14	Art. 10.220	□14	Art. 10.232	□14	Art. 10.244	□14	Art. 10.256	□14	Art. 10.268	□14	Art. 10.268	□14
Art. 10.197	Ø 16	Art. 10.209	Ø 16	Art. 10.221	□16	Art. 10.233	□16	Art. 10.245	□16	Art. 10.257	□16	Art. 10.269	□16	Art. 10.269	□16
H.1500 mm.		H.1500 mm.		H.1500 mm.		H.1500 mm.		H.1500 mm.		H.1500 mm.		H.1500 mm.			
Art. 10.198	Ø 12	Art. 10.210	Ø 12	Art. 10.222	□12	Art. 10.234	□12	Art. 10.246	□12	Art. 10.258	□12	Art. 10.270	□12	Art. 10.270	□12
Art. 10.199	Ø 14	Art. 10.211	Ø 14	Art. 10.223	□14	Art. 10.235	□14	Art. 10.247	□14	Art. 10.259	□14	Art. 10.271	□14	Art. 10.271	□14
Art. 10.200	Ø 16	Art. 10.212	Ø 16	Art. 10.224	□16	Art. 10.236	□16	Art. 10.248	□16	Art. 10.260	□16	Art. 10.272	□16	Art. 10.272	□16

Tutte le parti di questo catalogo - foto comprese - sono di proprietà Euro-Fer. La riproduzione, anche parziale, è vietata in ogni forma e con ogni mezzo. / Every part of this catalogue - photos included - is Euro-Fer's property. All forms of copying are strictly prohibited.

PALLINE PICCOLE / SMALL BALLS



*Martellato
Hammered*
H.950 mm.
Art. 10.273 □12
Art. 10.274 □14
Art. 10.275 □16
H.1000 mm.
Art. 10.276 □12
Art. 10.277 □14
Art. 10.278 □16
H.1200 mm.
Art. 10.279 □12
Art. 10.280 □14
Art. 10.281 □16
H.1500 mm.
Art. 10.282 □12
Art. 10.283 □14
Art. 10.284 □16

*Martellato
Hammered*
H.950 mm.
Art. 10.285 □12
Art. 10.286 □14
Art. 10.287 □16
H.1000 mm.
Art. 10.288 □12
Art. 10.289 □14
Art. 10.290 □16
H.1200 mm.
Art. 10.291 □12
Art. 10.292 □14
Art. 10.293 □16
H.1500 mm.
Art. 10.294 □12
Art. 10.295 □14
Art. 10.296 □16

*Martellato
Hammered*
H.950 mm.
Art. 10.297 □12
Art. 10.298 □14
Art. 10.299 □16
H.1000 mm.
Art. 10.300 □12
Art. 10.301 □14
Art. 10.302 □16
H.1200 mm.
Art. 10.303 □12
Art. 10.304 □14
Art. 10.305 □16
H.1500 mm.
Art. 10.306 □12
Art. 10.307 □14
Art. 10.308 □16

*Martellato
Hammered*
H.950 mm.
Art. 10.309 □12
Art. 10.310 □14
Art. 10.311 □16
H.1000 mm.
Art. 10.312 □12
Art. 10.313 □14
Art. 10.314 □16
H.1200 mm.
Art. 10.315 □12
Art. 10.316 □14
Art. 10.317 □16
H.1500 mm.
Art. 10.318 □12
Art. 10.319 □14
Art. 10.320 □16

*Martellato
Hammered*
H.950 mm.
Art. 10.321 □12
Art. 10.322 □14
Art. 10.323 □16
H.1000 mm.
Art. 10.324 □12
Art. 10.325 □14
Art. 10.326 □16
H.1200 mm.
Art. 10.327 □12
Art. 10.328 □14
Art. 10.329 □16
H.1500 mm.
Art. 10.330 □12
Art. 10.331 □14
Art. 10.332 □16

Tondo / Round
H.950 mm.
Art. 10.333 Ø 12
Art. 10.334 Ø 14
Art. 10.335 Ø 16
H.1000 mm.
Art. 10.336 Ø 12
Art. 10.337 Ø 14
Art. 10.338 Ø 16
H.1200 mm.
Art. 10.339 Ø 12
Art. 10.340 Ø 14
Art. 10.341 Ø 16
H.1500 mm.
Art. 10.342 Ø 12
Art. 10.343 Ø 14
Art. 10.344 Ø 16

Tondo / Round
H.950 mm.
Art. 10.345 Ø 12
Art. 10.346 Ø 14
Art. 10.347 Ø 16
H.1000 mm.
Art. 10.348 Ø 12
Art. 10.349 Ø 14
Art. 10.350 Ø 16
H.1200 mm.
Art. 10.351 Ø 12
Art. 10.352 Ø 14
Art. 10.353 Ø 16
H.1500 mm.
Art. 10.354 Ø 12
Art. 10.355 Ø 14
Art. 10.356 Ø 16

PALLINE PICCOLE / SMALL BALLS

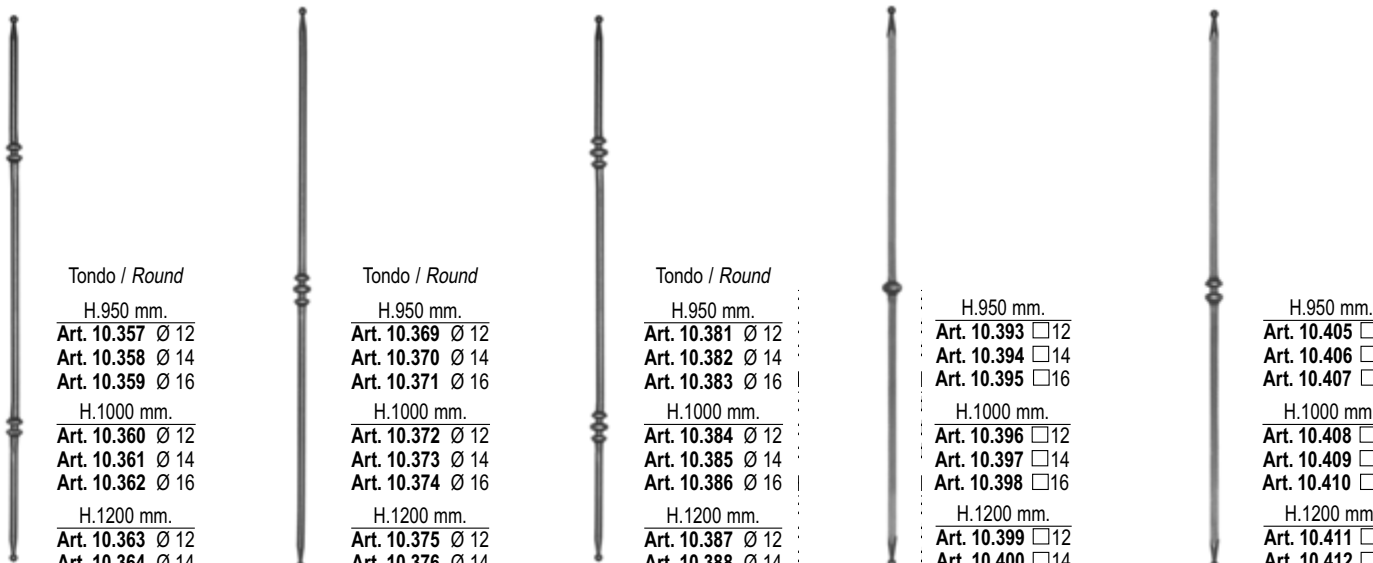

Tondo / Round
H.950 mm.
Art. 10.357 Ø 12
Art. 10.358 Ø 14
Art. 10.359 Ø 16
H.1000 mm.
Art. 10.360 Ø 12
Art. 10.361 Ø 14
Art. 10.362 Ø 16
H.1200 mm.
Art. 10.363 Ø 12
Art. 10.364 Ø 14
Art. 10.365 Ø 16
H.1500 mm.
Art. 10.366 Ø 12
Art. 10.367 Ø 14
Art. 10.368 Ø 16

Tondo / Round
H.950 mm.
Art. 10.369 Ø 12
Art. 10.370 Ø 14
Art. 10.371 Ø 16
H.1000 mm.
Art. 10.372 Ø 12
Art. 10.373 Ø 14
Art. 10.374 Ø 16
H.1200 mm.
Art. 10.375 Ø 12
Art. 10.376 Ø 14
Art. 10.377 Ø 16
H.1500 mm.
Art. 10.378 Ø 12
Art. 10.379 Ø 14
Art. 10.380 Ø 16

Tondo / Round
H.950 mm.
Art. 10.381 Ø 12
Art. 10.382 Ø 14
Art. 10.383 Ø 16
H.1000 mm.
Art. 10.384 Ø 12
Art. 10.385 Ø 14
Art. 10.386 Ø 16
H.1200 mm.
Art. 10.387 Ø 12
Art. 10.388 Ø 14
Art. 10.389 Ø 16
H.1500 mm.
Art. 10.390 Ø 12
Art. 10.391 Ø 14
Art. 10.392 Ø 16

H.950 mm.
Art. 10.393 □12
Art. 10.394 □14
Art. 10.395 □16
H.1000 mm.
Art. 10.396 □12
Art. 10.397 □14
Art. 10.398 □16
H.1200 mm.
Art. 10.399 □12
Art. 10.400 □14
Art. 10.401 □16
H.1500 mm.
Art. 10.402 □12
Art. 10.403 □14
Art. 10.404 □16

H.950 mm.
Art. 10.405 □12
Art. 10.406 □14
Art. 10.407 □16
H.1000 mm.
Art. 10.408 □12
Art. 10.409 □14
Art. 10.410 □16
H.1200 mm.
Art. 10.411 □12
Art. 10.412 □14
Art. 10.413 □16
H.1500 mm.
Art. 10.414 □12
Art. 10.415 □14
Art. 10.416 □16

Tutte le parti di questo catalogo - foto comprese - sono di proprietà Euro-Fer. La riproduzione, anche parziale, è vietata in ogni forma e con ogni mezzo. / Every part of this catalogue - photos included - is Euro-Fer's property. All forms of copying are strictly prohibited.

PALLINE PICCOLE / SMALL BALLS



H.950 mm.
Art. 10.417 □12
Art. 10.418 □14
Art. 10.419 □16

H.950 mm.
Art. 10.429 □12
Art. 10.430 □14
Art. 10.431 □16

H.950 mm.
Art. 10.441 □12
Art. 10.442 □14
Art. 10.443 □16

Martellato
Hammered
H.950 mm.
Art. 10.453 □12
Art. 10.454 □14
Art. 10.455 □16

Martellato
Hammered
H.950 mm.
Art. 10.465 □12
Art. 10.466 □14
Art. 10.467 □16

Martellato
Hammered
H.950 mm.
Art. 10.477 □12
Art. 10.478 □14
Art. 10.479 □16

Martellato
Hammered
H.950 mm.
Art. 10.489 □12
Art. 10.490 □14
Art. 10.491 □16

H.1000 mm.
Art. 10.420 □12
Art. 10.421 □14
Art. 10.422 □16

H.1000 mm.
Art. 10.432 □12
Art. 10.433 □14
Art. 10.434 □16

H.1000 mm.
Art. 10.444 □12
Art. 10.445 □14
Art. 10.446 □16

H.1000 mm.
Art. 10.456 □12
Art. 10.457 □14
Art. 10.458 □16

H.1000 mm.
Art. 10.468 □12
Art. 10.469 □14
Art. 10.470 □16

H.1000 mm.
Art. 10.480 □12
Art. 10.481 □14
Art. 10.482 □16

H.1000 mm.
Art. 10.492 □12
Art. 10.493 □14
Art. 10.494 □16

H.1200 mm.
Art. 10.423 □12
Art. 10.424 □14
Art. 10.425 □16

H.1200 mm.
Art. 10.435 □12
Art. 10.436 □14
Art. 10.437 □16

H.1200 mm.
Art. 10.447 □12
Art. 10.448 □14
Art. 10.449 □16

H.1200 mm.
Art. 10.459 □12
Art. 10.460 □14
Art. 10.461 □16

H.1200 mm.
Art. 10.471 □12
Art. 10.472 □14
Art. 10.473 □16

H.1200 mm.
Art. 10.483 □12
Art. 10.484 □14
Art. 10.485 □16

H.1200 mm.
Art. 10.495 □12
Art. 10.496 □14
Art. 10.497 □16

H.1500 mm.
Art. 10.426 □12
Art. 10.427 □14
Art. 10.428 □16

H.1500 mm.
Art. 10.438 □12
Art. 10.439 □14
Art. 10.440 □16

H.1500 mm.
Art. 10.450 □12
Art. 10.451 □14
Art. 10.452 □16

H.1500 mm.
Art. 10.462 □12
Art. 10.463 □14
Art. 10.464 □16

H.1500 mm.
Art. 10.474 □12
Art. 10.475 □14
Art. 10.476 □16

H.1500 mm.
Art. 10.486 □12
Art. 10.487 □14
Art. 10.488 □16

H.1500 mm.
Art. 10.498 □12
Art. 10.499 □14
Art. 10.500 □16

PALLINE PICCOLE / SMALL BALLS



Martellato
Hammered

H.950 mm.
Art. 10.501 □12
Art. 10.502 □14
Art. 10.503 □16

H.1000 mm.
Art. 10.504 □12
Art. 10.505 □14
Art. 10.506 □16

H.1200 mm.
Art. 10.507 □12
Art. 10.508 □14
Art. 10.509 □16

H.1500 mm.
Art. 10.510 □12
Art. 10.511 □14
Art. 10.512 □16

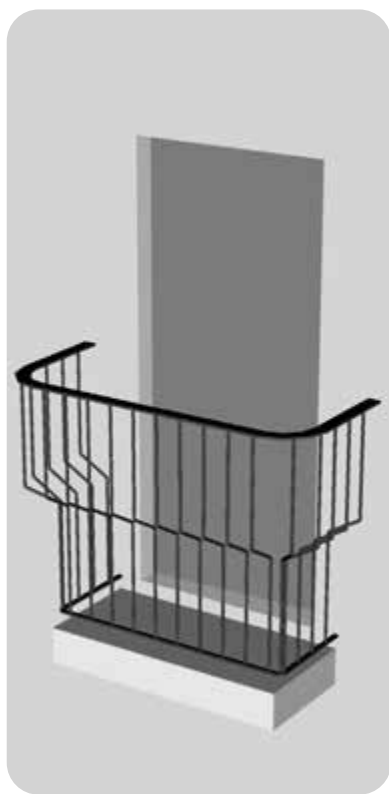

Liscio / Smooth
H 950 x L.130 mm
Art. 10.600 □12

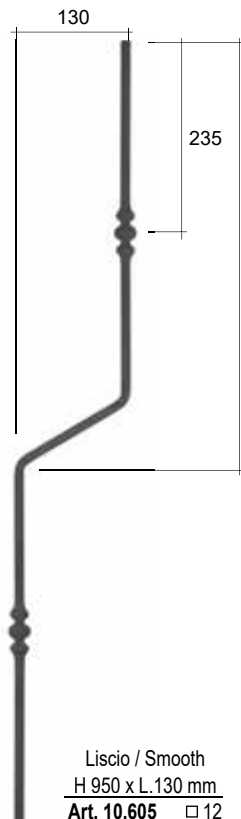

Liscio / Smooth
H 950 x L.130 mm
Art. 10.605 □12



Liscio / Smooth
H 950 x L.130 mm
Art. 10.650 □12

Nuovi ricalcati corteccia e rigati martellati / *New forged bars bark model and fluted hammered*



Corteccia / *Bark model*
H.950 mm

- Art. 10.001.CO Ø 16
- Art. 10.001.01.CO Ø 14
- Art. 10.001.02.CO Ø 12
- Art. 10.013.CO □ 14
- Art. 10.013.01.CO □ 16
- Art. 10.013.02.CO □ 12
- H.1000 mm
- Art. 10.002.CO Ø 16
- Art. 10.002.01.CO Ø 14
- Art. 10.002.02.CO Ø 12
- Art. 10.014.CO □ 14
- Art. 10.014.01.CO □ 16
- Art. 10.014.02.CO □ 12

Corteccia / *Bark model*
H.950 mm

- Art. 10.040.15.CO □ 12
- Art. 10.040.16.CO □ 14
- Art. 10.040.17.CO □ 16
- H.1000 mm
- Art. 10.040.18.CO □ 12
- Art. 10.040.19.CO □ 14
- Art. 10.040.20.CO □ 16

Corteccia / *Bark model*
H.950 mm

- Art. 10.005.CO Ø 16
- Art. 10.005.01.CO Ø 14
- Art. 10.005.02.CO Ø 12
- Art. 10.017.CO □ 14
- Art. 10.017.01.CO □ 16
- Art. 10.017.02.CO □ 12
- H.1000 mm
- Art. 10.006.CO Ø 16
- Art. 10.006.01.CO Ø 14
- Art. 10.006.02.CO Ø 12
- Art. 10.018.CO □ 14
- Art. 10.018.01.CO □ 16
- Art. 10.018.02.CO □ 12

Corteccia / *Bark model*
H.950 mm

- Art. 10.009.CO Ø 16
- Art. 10.009.01.CO Ø 14
- Art. 10.009.02.CO Ø 12
- Art. 10.021.CO □ 14
- Art. 10.021.01.CO □ 16
- Art. 10.021.02.CO □ 12
- H.1000 mm
- Art. 10.010.CO Ø 16
- Art. 10.010.01.CO Ø 14
- Art. 10.010.02.CO Ø 12
- Art. 10.022.CO □ 14
- Art. 10.022.01.CO □ 16
- Art. 10.022.02.CO □ 12

Corteccia / *Bark model*
H.950 mm

- Art. 10.026.CO Ø 16
- Art. 10.026.01.CO Ø 14
- Art. 10.026.02.CO Ø 12
- Art. 10.025.CO □ 14
- Art. 10.025.01.CO □ 16
- Art. 10.025.02.CO □ 12
- H.1000 mm
- Art. 10.028.CO Ø 16
- Art. 10.028.01.CO Ø 14
- Art. 10.028.02.CO Ø 12
- Art. 10.027.CO □ 14
- Art. 10.027.01.CO □ 16
- Art. 10.027.02.CO □ 12

Corteccia / *Bark model*
H.950 mm

- Art. 10.034.CO Ø 16
- Art. 10.034.01.CO Ø 14
- Art. 10.034.02.CO Ø 12
- Art. 10.033.CO □ 14
- Art. 10.033.01.CO □ 16
- Art. 10.033.02.CO □ 12
- H.1000 mm
- Art. 10.036.CO Ø 16
- Art. 10.036.01.CO Ø 14
- Art. 10.036.02.CO Ø 12
- Art. 10.035.CO □ 14
- Art. 10.035.01.CO □ 16
- Art. 10.035.02.CO □ 12

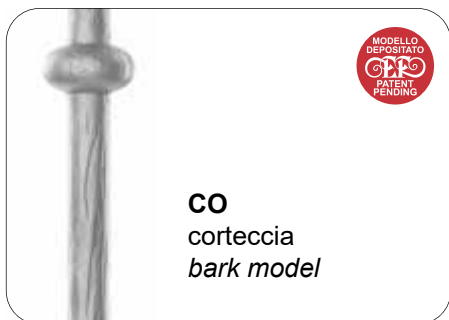

Tutte le parti di questo catalogo - foto comprese - sono di proprietà Euro-Fer. La riproduzione, anche parziale, è vietata in ogni forma e con ogni mezzo. / Every part of this catalogue - photos included - is Euro-Fer's property. All forms of copying are strictly prohibited.

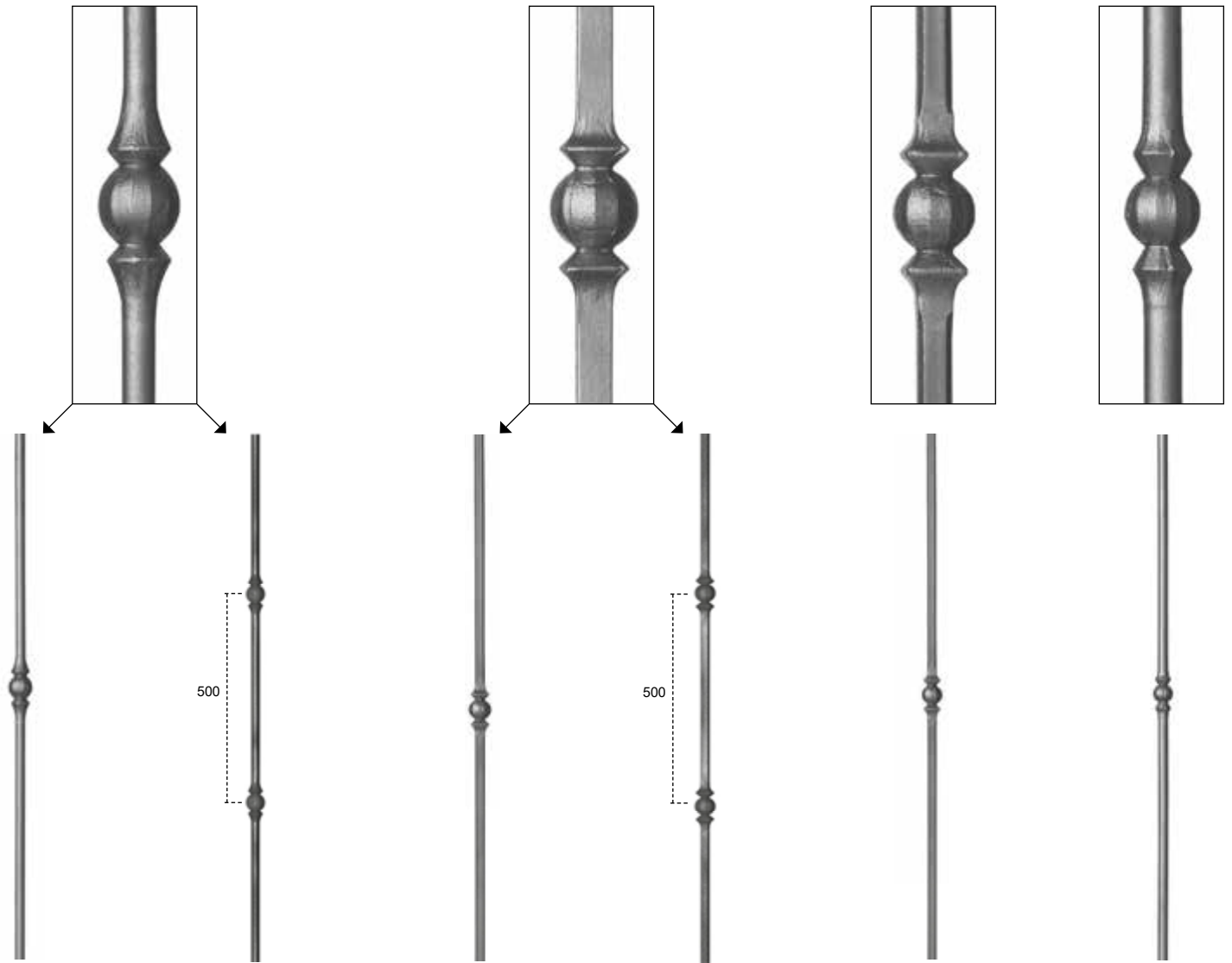

Art.11001L.T12.950
Art.11001L.T12.1000
Art.11001L.T12.1200
Art.11001L.T12.1500

Art.11001.01L.T12.950 NEW
Art.11001.01L.T12.1000

Art.11001.01L.T14.950 NEW
Art.11001.01L.T14.1000

Art.11001L.T14.950
Art.11001F.T14.950 NEW
Art.11001L.T14.1000
Art.11001F.T14.1000 NEW
Art.11001L.T14.1200
Art.11001L.T14.1500

Art.11001L.T16.950
Art.11001L.T16.1000
Art.11001L.T16.1200
Art.11001L.T16.1500

Art.11002L.Q12.950
Art.11002F.Q12.950
Art.11002M.Q12.950

Art.11002L.Q12.1000
Art.11002F.Q12.1000
Art.11002M.Q12.1000

Art.11002L.Q12.1200
Art.11002F.Q12.1200
Art.11002M.Q12.1200

Art.11002L.Q12.1500
Art.11002F.Q12.1500
Art.11002M.Q12.1500

Art.11002L.Q14.950
Art.11002F.Q14.950
Art.11002M.Q14.950

Art.11002L.Q14.1000
Art.11002F.Q14.1000
Art.11002M.Q14.1000

Art.11002L.Q14.1200
Art.11002F.Q14.1200
Art.11002M.Q14.1200

Art.11002L.Q14.1500
Art.11002F.Q14.1500
Art.11002M.Q14.1500

Art.11002L.Q16.950
Art.11002L.Q16.1000
Art.11002L.Q16.1200
Art.11002L.Q16.1500

Art.11003L.Q12.950
Art.11003F.Q12.950 NEW
Art.11003L.Q12.1000
Art.11003F.Q12.1000

Art.11003L.Q14.950 NEW
Art.11003L.Q14.1000
Art.11003F.Q14.1000

Art.11003L.Q16.1000

Art.11002S.Q12.950
Art.11002S.Q12.1000
Art.11002S.Q12.1200
Art.11002S.Q12.1500

Art.11003.01L.T12.950
Art.11003.01F.T12.950

Art.11003.01L.T12.1000
Art.11003.01F.T12.1000

Art.11003.01L.T12.1200
Art.11003.01F.T12.1200

Art.11003.01L.T12.1500
Art.11003.01F.T12.1500

Art.11003.01L.T14.950
Art.11003.01L.T14.1000
Art.11003.01L.T14.1200
Art.11003.01L.T14.1500

Legenda / Legend

Q QUADRO / SQUARE IRON
T TONDO / ROUND IRON
F FORGIATO / FORGED
L LISCIO / SMOOTH
M MARTELLATO / HAMMERED
S SMUSSATO / BLUNTED

Le misure sono in millimetri / sizes are in mm

Q - Quadro / Square iron

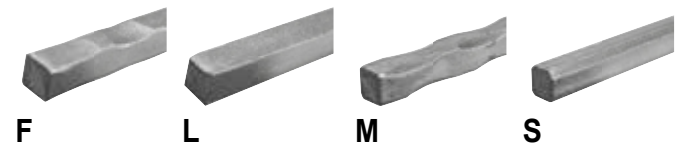

T - Tondo / Round iron

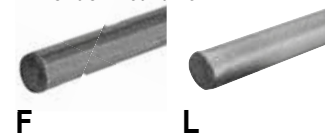

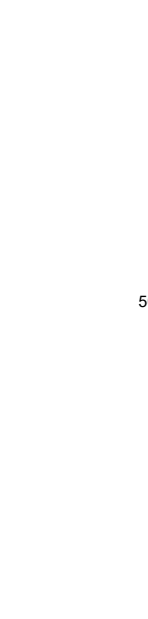
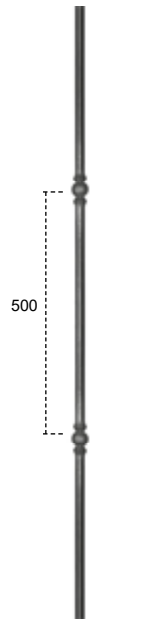
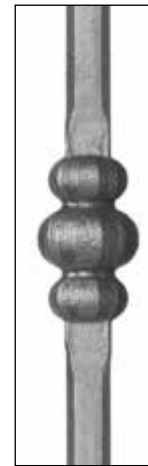
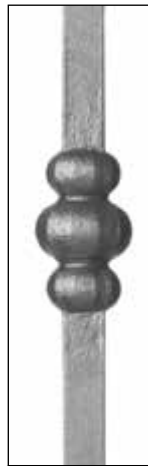
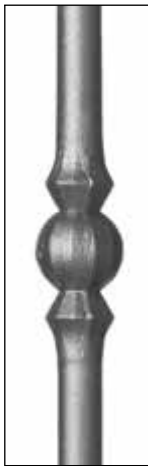

Art.11003.02L.T12.950 NEW

Art.11003.02L.T12.1000
Art.11003.02F.T12.1000

Art. 11004L.Q12.1000

Art. 11004L.Q12.1200
Art. 11004F.Q12.1000
Art. 11004F.Q12.1200

Art.11008L.Q12.950
Art.11008F.Q12.950
Art.11008M.Q12.950

Art.11008L.Q12.1000
Art.11008F.Q12.1000
Art.11008M.Q12.1000

Art.11008L.Q12.1200
Art.11008F.Q12.1200
Art.11008M.Q12.1200

Art.11008L.Q12.1500
Art.11008F.Q12.1500
Art.11008M.Q12.1500

Art.11008L.Q14.950
Art.11008F.Q14.950
Art.11008M.Q14.950
Art.11008L.Q14.1000
Art.11008F.Q14.1000
Art.11008M.Q14.1000

Art.11008L.Q14.1200
Art.11008F.Q14.1200
Art.11008M.Q14.1200
Art.11008L.Q14.1500
Art.11008F.Q14.1500
Art.11008M.Q14.1500

Art.11008.01L.Q12.950 NEW

Art.11008.01L.Q12.1000
Art.11008.01F.Q12.1000
Art.11008.01M.Q12.1000

Art.11008.01L.Q14.1000
Art.11008.01F.Q14.1000
Art.11008.01M.Q14.1000

Art.11008S.Q12.950

Art.11008S.Q12.1000
Art.11008S.Q12.1200
Art.11008S.Q12.1500

Art.11008.04L.T12.950

Art.11008.04L.T12.1000
Art.11008.04L.T12.1200
Art.11008.04L.T12.1500

Art.11008.04L.T14.950
Art.11008.04L.T14.1000
Art.11008.04L.T14.1200
Art.11008.04L.T14.1500

Legenda / Legend

Q QUADRO / SQUARE IRON

T TONDO / ROUND IRON

F FORGIATO / FORGED

L LISCIO / SMOOTH

M MARTELLATO / HAMMERED

S SMUSSATO / BLUNTED

Le misure sono in millimetri / sizes are in mm

Q - Quadro / Square iron

T - Tondo / Round iron

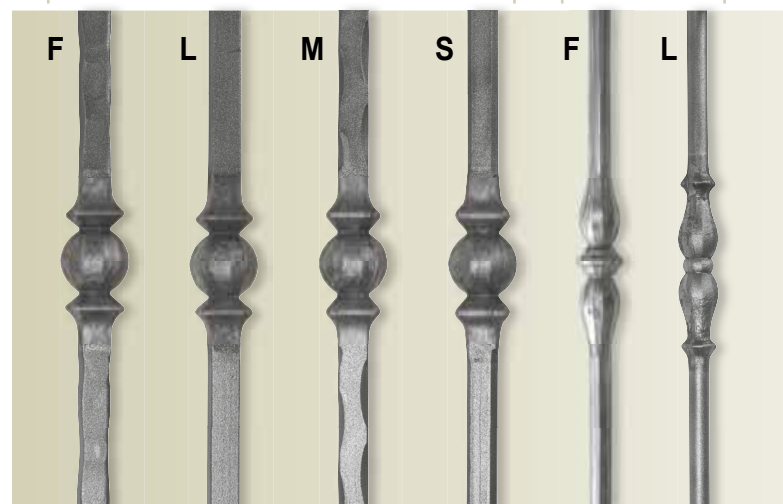

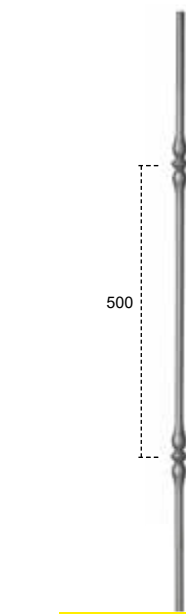
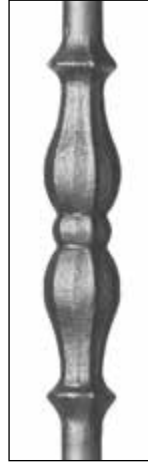

Art. 11014.10L.T12.1000
Art. 11014.10L.T12.1200
Art. 11014.10F.T12.1000
Art. 11014.10F.T12.1200

Art.11017.03L.T12.950
Art.11017.03F.T12.950

Art.11017.03L.T12.1000
Art.11017.03F.T12.1000

Art.11017.03L.T12.1200
Art.11017.03F.T12.1200

Art.11017.03L.T12.1500
Art.11017.03F.T12.1500

Art.11017.05L.T14.950
Art.11017.05L.T14.1000

Art.11017.05F.T14.1000 NEW
Art.11017.05L.T14.1200
Art.11017.05L.T14.1500

Art.11017.04L.T12.950
Art.11017.04L.T12.1000
NEW

Art.11017.01L.T12.950
Art.11017.01F.T12.950

Art.11017.01L.T12.1000
Art.11017.01F.T12.1000

Art.11017.01L.T12.1200
Art.11017.01F.T12.1200

Art.11017.01L.T12.1500
Art.11017.01F.T12.1500

Art.11017.01L.T14.950
Art.11017.01F.T14.950

Art.11017.01L.T14.1000
Art.11017.01F.T14.1000

Art.11017.01L.T14.1200
Art.11017.01F.T14.1200

Art.11017.01L.T14.1500
Art.11017.01F.T14.1500

Art.11023.04L.T.12.950
Art.11023.04L.T12.1000
Art.11023.04L.T12.1200
Art.11023.04L.T12.1500

Art. 11041.36L.T12.1000
Art. 11041.36L.T12.1200
Art. 11041.36F.T12.1000
Art. 11041.36F.T12.1200

Legenda / Legend

- Q** QUADRO / SQUARE IRON
- T** TONDO / ROUND IRON
- F** FORGIATO / FORGED
- L** LISCIO / SMOOTH
- M** MARTELLATO / HAMMERED
- S** SMUSSATO / BLUNTED

Le misure sono in millimetri / sizes are in mm



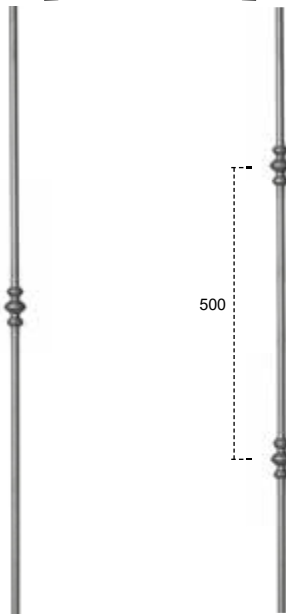
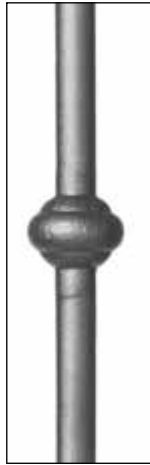

Art.11041.54L.Q12.950
Art.11041.54L.T12.950

Art.11041.55L.Q12.1000
Art.11041.55L.T12.1000

Art.11041.58L.T12.950
Art.11041.58L.Q12.950

Art.11041.60L.Q12.950
Art.11041.60L.Q12.1000

Art.11041.68L.T12.950
Art.11041.68L.T12.1000

Art.11041.70L.Q14.950
Art.11041.70L.Q14.1000
Art.11041.70L.Q14.1200
Art.11041.70L.Q14.1500

Art.11041.54L.Q12.1000
Art.11041.54L.T12.1000

Art.11041.55L.Q14.1000
Art.11041.55L.T14.1000

Art.11041.58L.T12.1000
Art.11041.58L.Q12.1000

Art.11041.58L.T12.1200
Art.11041.58L.Q12.1200

Art.11041.54L.Q12.1200
Art.11041.54L.T12.1200

Art.11041.54L.Q12.1500
Art.11041.54L.T12.1500

Art.11041.58L.T12.1500
Art.11041.58L.Q12.1500

Art.11041.54L.Q14.950
Art.11041.54L.T14.950

Art.11041.58L.T14.1000
Art.11041.58L.Q14.1000

Art.11041.54L.Q14.1000
Art.11041.54L.T14.1000

Art.11041.54L.Q14.1200
Art.11041.54L.T14.1200

Art.11041.54L.Q14.1500
Art.11041.54L.T14.1500

SU RICHIESTA / ON REQUEST

Tutti gli articoli di questo catalogo possono essere realizzati con queste lance / All articles in this catalogue can be realized with these spears.

P
PALLINA PICCOLA
SMALL BALL

PP
PUNTA A PIRAMIDE
PYRAMIDAL END

A
FIAMMA
FLAME

CT
CODA DI TOPO
TAIL END

11002L.Q12.950 + AP = 11002L.Q12.950AP

Per ordinare i paletti seguire l'esempio
To order bars please follow the example:

Tutte le parti di questo catalogo - foto comprese - sono di proprietà Euro-Fer. La riproduzione, anche parziale, è vietata in ogni forma e con ogni mezzo. / Every part of this catalogue - photos included - is Euro-Fer's property. All forms of copying are strictly prohibited.

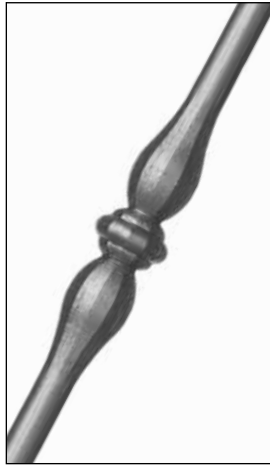

SU RICHIESTA / ON REQUEST

Tutti gli articoli di questo catalogo possono essere realizzati con queste lance / All articles in this catalogue can be realized with these spears.



P = PALLINA PICCOLA / SMALL BALL



A = FIAMMA/FLAME



AP = FIAMMA E PALLINA GRANDE / FLAME AND BIG BALL



PP = PUNTA A PIRAMIDE / PYRAMIDAL END



CT = CODA DI TOPO / TAIL END

Per ordinare i paletti seguire l'esempio / To order bars please follow the example:

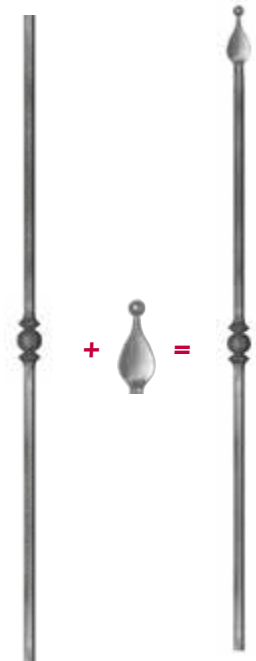

11002L.Q12.950 + AP = 11002L.Q12.950AP



Art.11098.02L.Q14.950
Art.11098.02L.Q14.1200
Art.11098.02L.Q14.1500
Art.11098.02L.Q14.1800



Art.11098.04L.T12.950
Art.11098.04L.T12.1200
Art.11098.04L.T12.1500
Art.11098.04L.T12.1800



Art.11090.01L.Q12.1000
Art.11090.01L.Q12.1200
Art.11090.01L.Q12.1500
Art.11090.01L.Q12.1800



Art.11091.01L.T12.1000
Art.11091.01L.T12.1200
Art.11091.01L.T12.1500
Art.11091.01L.T12.1800

Legenda / Legend

- Q** QUADRO / SQUARE IRON
- T** TONDO / ROUND IRON
- F** FORGIATO / FORGED
- L** LISCIO / SMOOTH
- M** MARTELLATO / HAMMERED
- S** SMUSSATO / BLUNTED

Le misure sono in millimetri
sizes are in mm



I forgiati italiani

Il Forgiato Italiano, la ricerca della qualità assoluta.

EUROFER evolve il classico paletto forgiato standard e crea il FORGIATO ITALIANO.

Con il FORGIATO ITALIANO puoi scegliere la misura, la texture, il decoro.

È fatto interamente in Italia e ti consente di inserire il motivo in ferro forgiato su un paletto liscio, martellato o smussato.

Forged bars made in Italy

The ITALIAN FORGED BARS: the pursuit of absolute quality.

EUROFER evolves the classic standard forged bollard and creates the ITALIAN FORGED BAR. With the ITALIAN FORGED BAR you can choose the size, the texture, the decor and the tip. It's made entirely in Italy and allows you to insert the forged iron motif on a smooth, hammered or beveled stake.



Art. 11002P.Q12.950
Art. 11002P.Q12.1000
Art. 11002P.Q12.1200
Art. 11002P.Q12.1500
Art. 11002P.Q12.3000
Art. 11002P.Q12.6000



Art. 11002P.Q14.950
Art. 11002P.Q14.1000
Art. 11002P.Q14.1200
Art. 11002P.Q14.1500
Art. 11002P.Q14.3000
Art. 11002P.Q14.6000



Art. 11017.01P.T12.950
Art. 11017.01P.T12.1000
Art. 11017.01P.T12.1200
Art. 11017.01P.T12.1500
Art. 11017.01P.T12.3000
Art. 11017.01P.T12.6000



Art. 11017.01P.T14.950
Art. 11017.01P.T14.1000
Art. 11017.01P.T14.1200
Art. 11017.01P.T14.1500
Art. 11017.01P.T14.3000
Art. 11017.01P.T14.6000

ELEMENTI IN FERRO FORGIATO E CAPISALDI
FORGED BARS AND POSTS

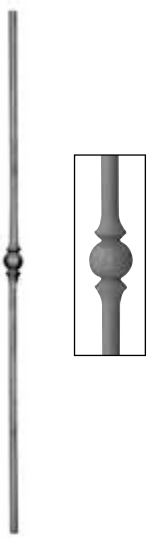

H.1000 mm.
Art. 11.001
Ø 14 circa



H.1000 mm.
Art. 11.001.01
Ø 14 circa

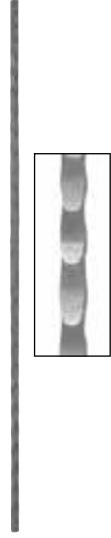

H.1000mm.
Art. 11.002.P □ 14 ca.
Art. 11.002.D.P □ 12 ca.

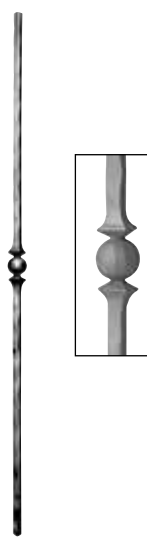

H.1000 mm.
Art. 11.002 □ 14 circa
Art. 11.002.E □ 10 circa
Art. 11.002.D □ 12 circa



H.1000 mm.
Art. 11.003 □ 14 circa
Art. 11.003.E □ 10 circa
Art. 11.003.D □ 12 circa



Rastremato / Tapered
H.1000 mm.
Art. 11.003.01.P
Ø 14 circa

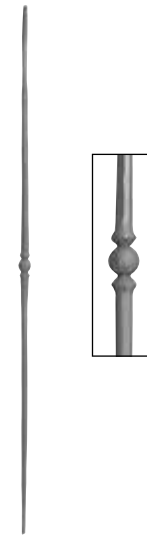

H.1000 mm.
Art. 11.003.01
Ø 14 circa
Art. 11.003.01.E
Ø 12 circa



H.1000 mm.
Art. 11.003.02
Ø 14 circa
Art. 11.003.02.E
Ø 12 circa

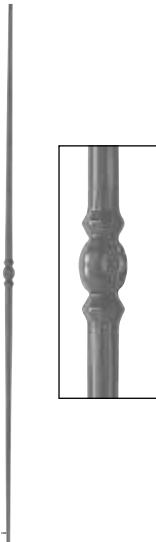

H.1000 mm.
Art. 11.003.03
Ø 14 circa



H.1000 mm.
Art. 11.003.04
Ø 14 circa

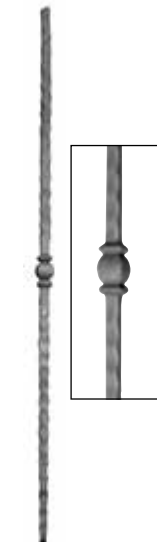

H.1000 mm.
Art. 11.004
□ 14 circa



H.1000 mm.
Art. 11.004.01
□ 14 circa



H.1000 mm.
Art. 11.004.02
□ 14 circa

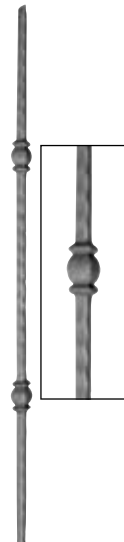

H.1000 mm.
Art. 11.005
□ 14 circa

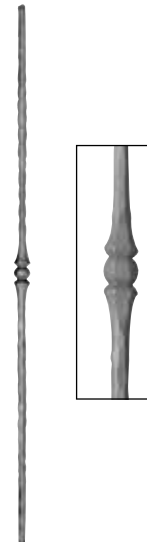

H.1000 mm.
Art. 11.006
□ 14 circa
Art. 11.006.01
Ø 14 circa



H.1000 mm.
Art. 11.007
□ 14 circa
Art. 11.007.01
Ø 14 circa

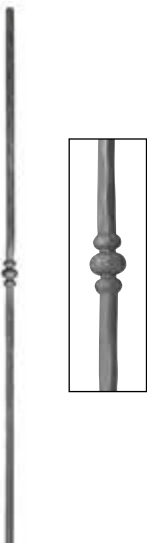

H.1000 mm.
Art. 11.008
□ 14 circa



H.1000 mm.
Art. 11.008.01
□ 14 circa

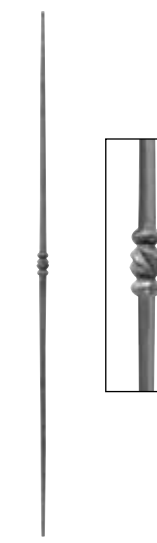

H.1000 mm.
Art. 11.008.02
Ø 14 circa



H.1000 mm.
Art. 11.008.03
Ø 14 circa



H.1000 mm.
Art. 11.008.04
Ø 12 circa



H.1000 mm.
Art. 11.008.05
Ø 12 circa



H.1000 mm
Art. 11.008.06
□ 12 circa



H.1000 mm
Art. 11.008.07
□ 12 circa

Tutte le parti di questo catalogo - foto comprese - sono di proprietà Euro-Fer. La riproduzione, anche parziale, è vietata in ogni forma e con ogni mezzo. / Every part of this catalogue - photos included - is Euro-Fer's property. All forms of copying are strictly prohibited.

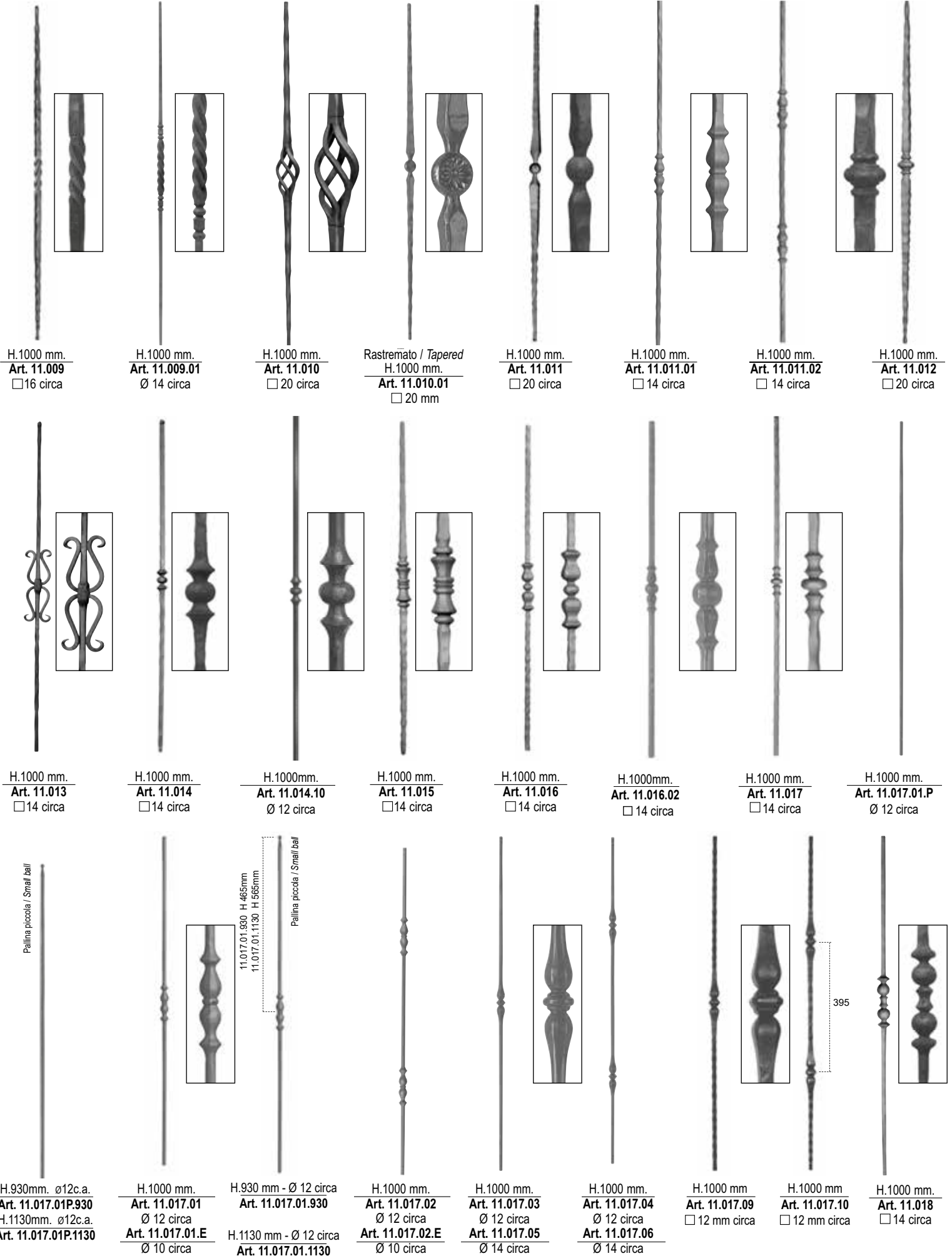

ELEMENTI IN FERRO FORGIATO E CAPISALDI
FORGED BARS AND POSTS

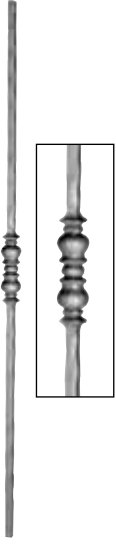

H.1000 mm.
Art. 11.019
□ 14 circa



H.1000 mm.
Art. 11.019.01
Ø 14 mm

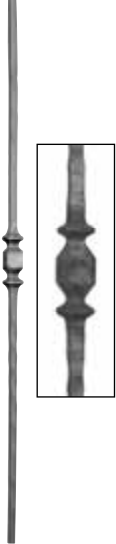

H.1000 mm.
Art. 11.020
□ 14 circa

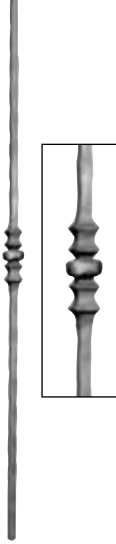

H.1000 mm.
Art. 11.021
□ 14 circa



H.1000 mm.
Art. 11.021.01
□ 14 circa



H.1000 mm.
Art. 11.022
□ 14 circa



Fuori Produzione
Out of Production

Art. 11.023



H.1000 mm.
Art. 11.023.01
□ 20 circa



Art. 11.023.02



Art. 11.023.03



H.1000 mm.
Art. 11.023.04
Ø 14 mm



H.1000 mm.
Art. 11.023.05
Ø 14 mm



H.1000 mm.
Art. 11.024
□ 14 circa



H.1000 mm.
Art. 11.025
□ 14 circa



H.1000 mm.
Art. 11.026



H.1000 mm.
Art. 11.027



H.1000 mm.
Art. 11.028



H.1000 mm.
Art. 11.029
□ 14 circa



H.1000 mm.
Art. 11.030
□ 14 circa



H.1000 mm.
Art. 11.031
□ 14 circa



H.1000 mm.
Art. 11.032
□ 14 circa



H.1000 mm.
Art. 11.033
□ 14 circa



H.1000 mm.
Art. 11.034
□ 14 circa



H.1000 mm.
Art. 11.035
□ 14 circa

Tutte le parti di questo catalogo - foto comprese - sono di proprietà Euro-Fer. La riproduzione, anche parziale, è vietata in ogni forma e con ogni mezzo. / Every part of this catalogue - photos included - is Euro-Fer's property. All forms of copying are strictly prohibited.

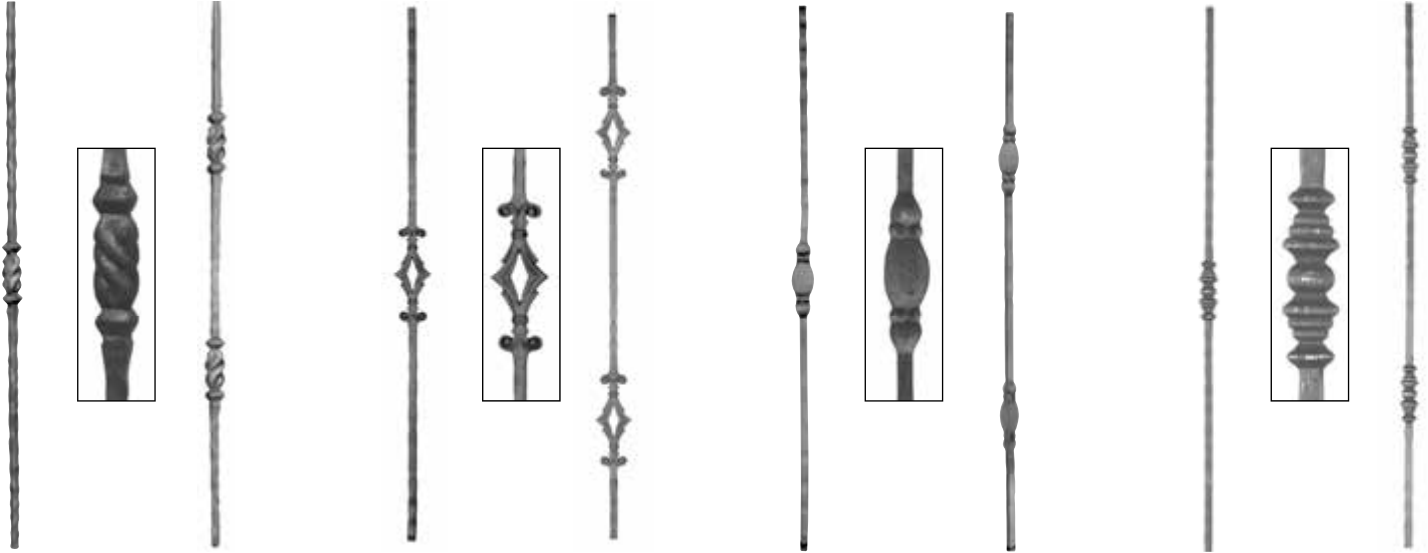

H.1000 mm. Art. 11.036 □ 14 circa
 H.1000 mm. Art. 11.037 □ 14 circa
 H.1000 mm. Art. 11.038 □ 14 circa
 H.1000 mm. Art. 11.039 □ 14 circa
 H.1000 mm. Art. 11.040 □ 12 circa
 H.1000 mm. Art. 11.041 □ 12 circa
 H.1000 mm. Art. 11.041.02 □ 14 circa
 H.1000 mm. Art. 11.041.03 □ 14 circa

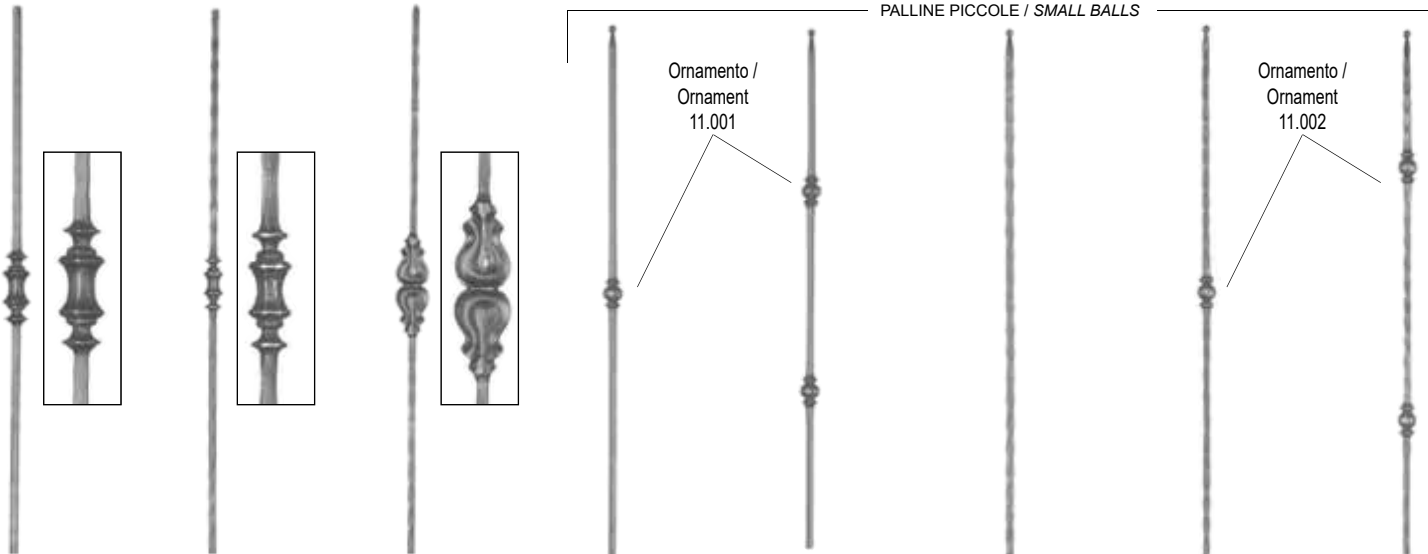

H.1000 mm. Art. 11.041.04 □ 14 circa
 H.1000 mm. Art. 11.041.05 □ 12 circa
 H.1000 mm. Art. 11.041.06 □ 12 circa
 Tondo / Round H.1000 mm. Art. 11.041.07 Ø 14 circa
 Tondo / Round H.1000 mm. Art. 11.041.08 Ø 14 circa
 H.1000 mm. Art. 11.041.09 □ 14 circa
 H.1000 mm. Art. 11.041.10 □ 14 circa
 H.1000 mm. Art. 11.041.11 □ 14 circa

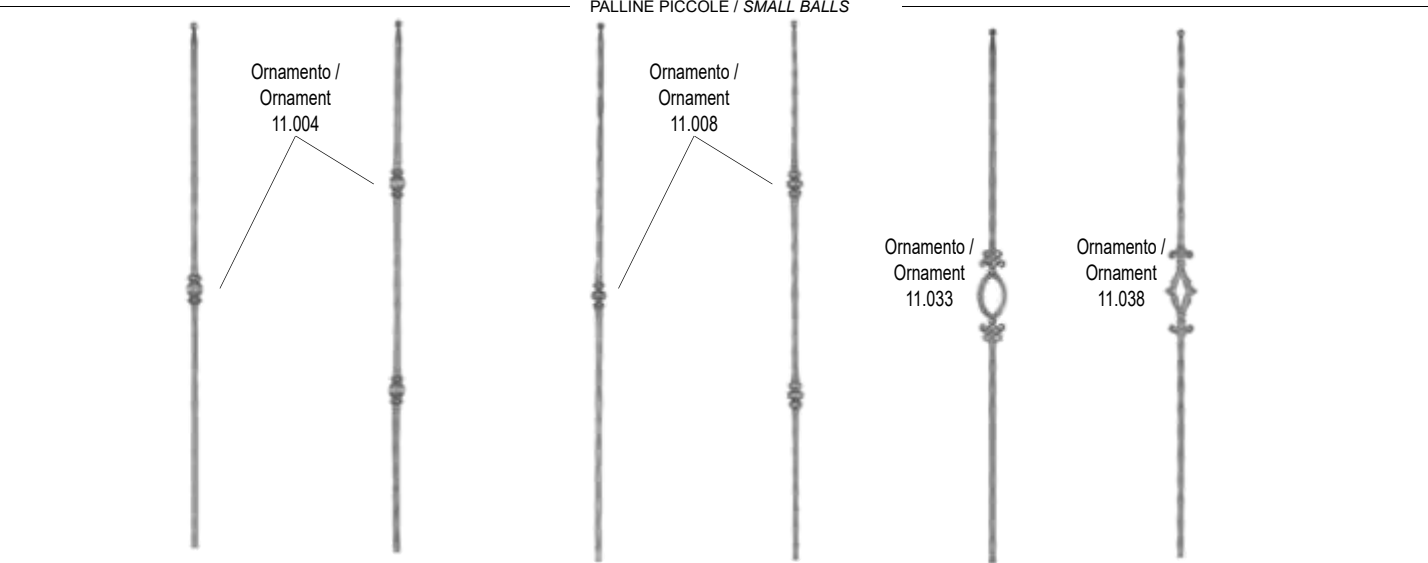

H.1000 mm. Art. 11.041.12 □ 14 circa
 H.1000 mm. Art. 11.041.13 □ 14 circa
 H.1000 mm. Art. 11.041.14 □ 14 circa
 H.1000 mm. Art. 11.041.15 □ 14 circa
 H.1000 mm. Art. 11.041.18 □ 14 circa
 H.1000 mm. Art. 11.041.19 □ 14 circa

Tutte le parti di questo catalogo - foto comprese - sono di proprietà Euro-Fer. La riproduzione, anche parziale, è vietata in ogni forma e con ogni mezzo. / Every part of this catalogue - photos included - is Euro-Fer's property. All forms of copying are strictly prohibited.

PALLINE PICCOLE / SMALL BALLS

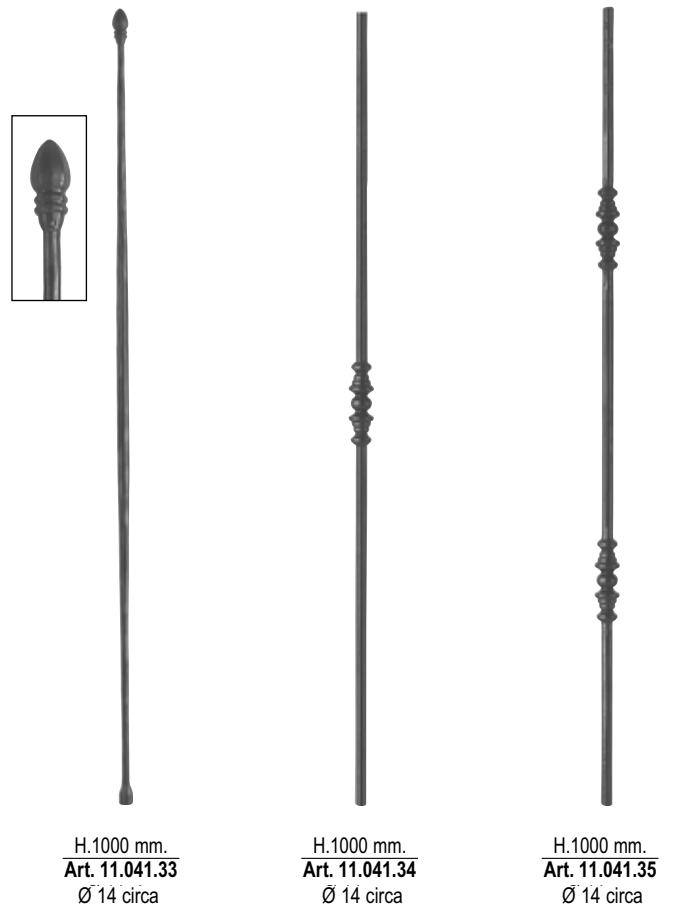
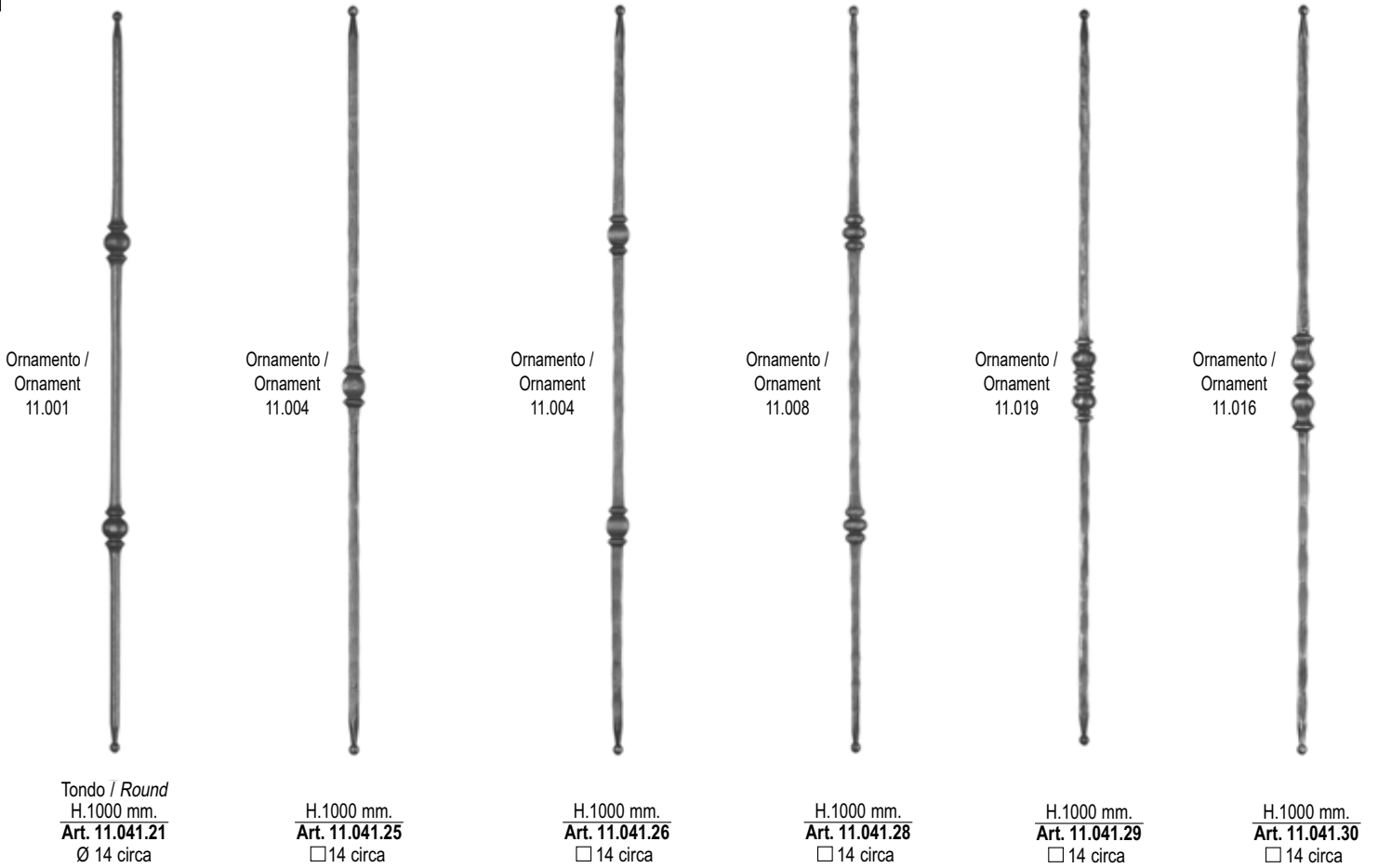

Tutte le parti di questo catalogo - foto comprese - sono di proprietà Euro-Fer. La riproduzione, anche parziale, è vietata in ogni forma e con ogni mezzo. / Every part of this catalogue - photos included - is Euro-Fer's property. All forms of copying are strictly prohibited.

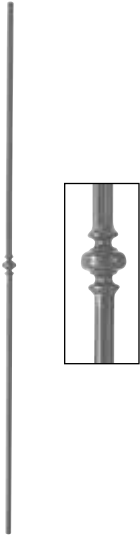

H.1000 mm.
Art. 11.041.36
Ø 12 mm circa



H.1000 mm.
Art. 11.041.37
Ø 12 mm circa



H.1000 mm.
Art. 11.041.38
□ 14 circa

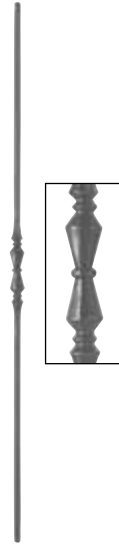

H. 1000 mm
Art. 11.041.39
Ø 12 mm circa



H.1000 mm.
Art. 11.041.40
□ 14 mm circa

*Fuori Produzione
Out of Production*

Art. 11.041.41



H.1000 mm.
Art. 11.041.42
Ø 14 mm circa

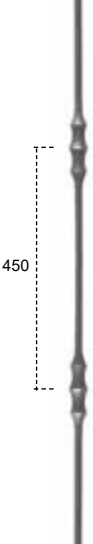

H.1000 mm.
Art. 11.041.43
Ø 14 mm circa

450



H.1000 mm.
Art. 11.041.44
Ø 14 mm circa

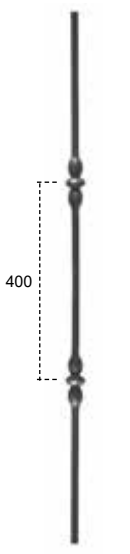

400

H.1000 mm.
Art. 11.041.45
Ø 14 mm circa

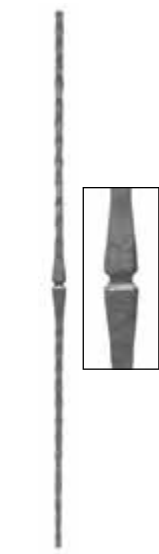

H.1000 mm.
Art. 11.041.46
□ 14 mm circa



H.1000 mm.
Art. 11.041.47
Ø 14 mm circa



H.1000 mm.
Art. 11.041.48
Ø 14 mm circa

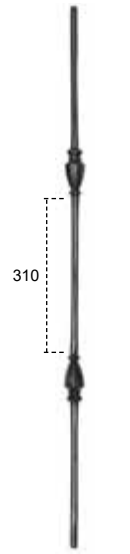

310

H.1000 mm.
Art. 11.041.49
Ø 14 mm circa

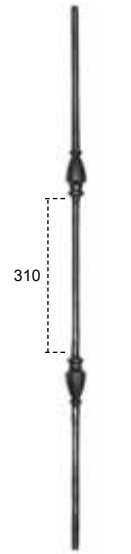

310

H.1000 mm.
Art. 11.041.50
Ø 14 mm circa

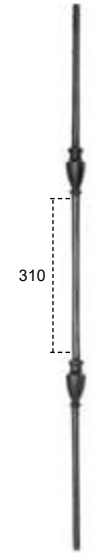

310

H.1000 mm.
Art. 11.041.51
Ø 14 mm circa

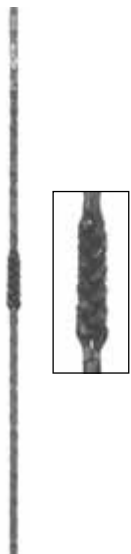

H.1000 mm
Art. 11.041.52
□ 12 mm ca.

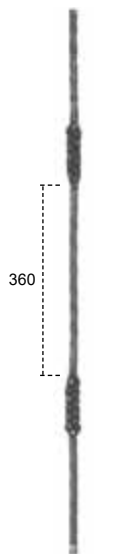

360

H.1000 mm
Art. 11.041.53
□ 12 mm ca.



H.1000 mm
Art. 11.041.54
Ø 12 mm ca.



490

H.1000 mm
Art. 11.041.55
Ø 12 mm ca.



H.1000 mm
Art. 11.041.68 Ø 12 ca.
Art. 11.041.69 Ø 14 ca.



Smussato / Blunted

H.1000 mm
Art. 11.041.70
□ 14 mm ca.

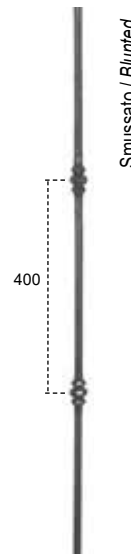

Smussato / Blunted

400

H.1000 mm
Art. 11.041.71
□ 14 mm ca.



**ELEMENTI IN FERRO FORGIATO E CAPISALDI
FORGED BARS AND POSTS**



H.1000 mm
Art. 11.041.72
□ 12 mm ca.

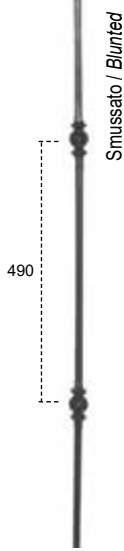

H.1000 mm
Art. 11.041.73
□ 12 mm ca.



H.1000 x L.120 mm
Art. 11.041.79
□ 14 mm ca.

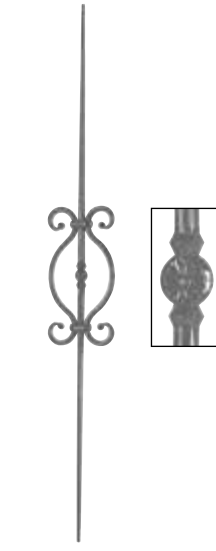

H.1000 X L.135. mm
Art. 11.041.80
Ø 14 mm circa



H.1000 X L.135 mm
Art. 11.041.81
Ø 14 mm circa

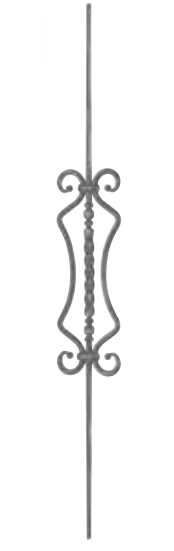

H.1000 X L.135 mm.
Art. 11.041.82
Ø 14 mm circa



H.1000 X L.135 mm.
Art. 11.041.83
Ø 12 mm circa



H.1000 X L.125 mm.
Art. 11.041.84
□ 14 mm circa



H.1000 X L.125 mm.
Art. 11.041.85
Ø 14 mm circa



H.1000 X L.125 mm.
Art. 11.041.86
□ 14 mm circa



Liscio / Smooth
H. 1000 mm
Art. 11.041.100 Ø 12 c.a.

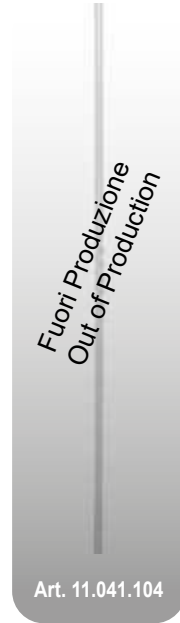

Art. 11.041.104



Art. 11.041.105



Art. 11.041.108



Forgiato / Forged
H.1000 mm
Art. 11.041.109 Ø 12 ca.



Art. 11.041.110



Forgiato / Forged
H.1000 mm
Art. 11.041.111 Ø12 ca.

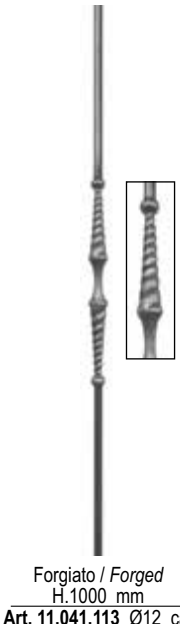

Forgiato / Forged
H.1000 mm
Art. 11.041.113 Ø12 ca.

Tutte le parti di questo catalogo - foto comprese - sono di proprietà Euro-Fer. La riproduzione, anche parziale, è vietata in ogni forma e con ogni mezzo. / Every part of this catalogue - photos included - is Euro-Fer's property. All forms of copying are strictly prohibited.

Fuori Produzione
Out of Production

Art. 11.041.115



Smussato / Blunted
H.1000 mm
Art. 11.041.118 □ 13 ca

Battuto / Beaten
H.1100 mm.
Art. 11.042 □ 20

Battuto / Beaten
H.1100 mm.
Art. 11.043 □ 25
Art. 11.044 □ 30

H.1100 mm.
Art. 11.044.01 □ 20

H.1100 mm.
Art. 11.044.02 □ 25
Art. 11.044.03 □ 30

H.1100 mm.
Art. 11.044.04 □ 20

H.1100 mm.
Art. 11.044.05 □ 25
Art. 11.044.06 □ 30

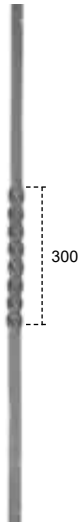

H.1200 mm.
Art. 11.044.07 □ 20
Art. 11.044.08 □ 25
Art. 11.044.09 □ 30

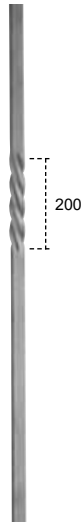

In Spigolo / Edged Bar
H.1200 mm.
Art. 11.045 □ 25
Art. 11.046 □ 30



H.1100 mm.
Art. 11.047 □ 20
Art. 11.048 □ 25
Art. 11.049 □ 30



Martellato / Hammered
H.1100 mm.
Art. 11.049.01 □ 20
Art. 11.049.02 □ 25
Art. 11.049.03 □ 30



Liscio / Smooth
H.1200 mm
Art. 11.049.08
Ø 25 circa

Fuori Produzione
Out of Production

Art. 11.049.11

Fuori Produzione
Out of Production

Art. 11.049.12



In Spigolo / Edged Bar
H.1200 mm.
Art. 11.050 □ 25
Art. 11.051 □ 30



Martellato / Hammered
H.1100 mm.
Art. 11.052 □ 20
Art. 11.052.01 □ 25
Art. 11.052.02 □ 30



H.1100 mm.
Art. 11.053 □ 20
Art. 11.053.01 □ 25
Art. 11.053.02 □ 30



H.1200 mm.
Art. 11.053.03 □ 25
Art. 11.053.04 □ 30



H.1200 mm.
Art. 11.053.05 □ 25
Art. 11.053.06 □ 30

Tutte le parti di questo catalogo - foto comprese - sono di proprietà Euro-Fer. La riproduzione, anche parziale, è vietata in ogni forma e con ogni mezzo. / Every part of this catalogue - photos included - is Euro-Fer's property. All forms of copying are strictly prohibited.



Martellato / Hammered
H.1200 mm.
Art. 11.053.07 □ 25
Art. 11.053.08 □ 30

Tondo / Round
H.1200 mm.
Art. 11.053.09 Ø 25
Art. 11.053.10 Ø 30

H.1200 mm.
Art. 11.053.11 □ 25
Art. 11.053.12 □ 30

Martellato / Hammered
H.1200 mm.
Art. 11.053.13 □ 25
Art. 11.053.14 □ 30

Tondo / Round
H.1200 mm.
Art. 11.053.15 Ø 25
Art. 11.053.16 Ø 30

H.1200 mm.
Art. 11.053.17 □ 20
Art. 11.053.18 □ 25
Art. 11.053.19 □ 30

Martellato / Hammered
H.1200 mm.
Art. 11.053.20 □ 20
Art. 11.053.21 □ 25
Art. 11.053.22 □ 30

Tondo / Round
H.1200 mm.
Art. 11.053.23 Ø 25
Art. 11.053.24 Ø 30

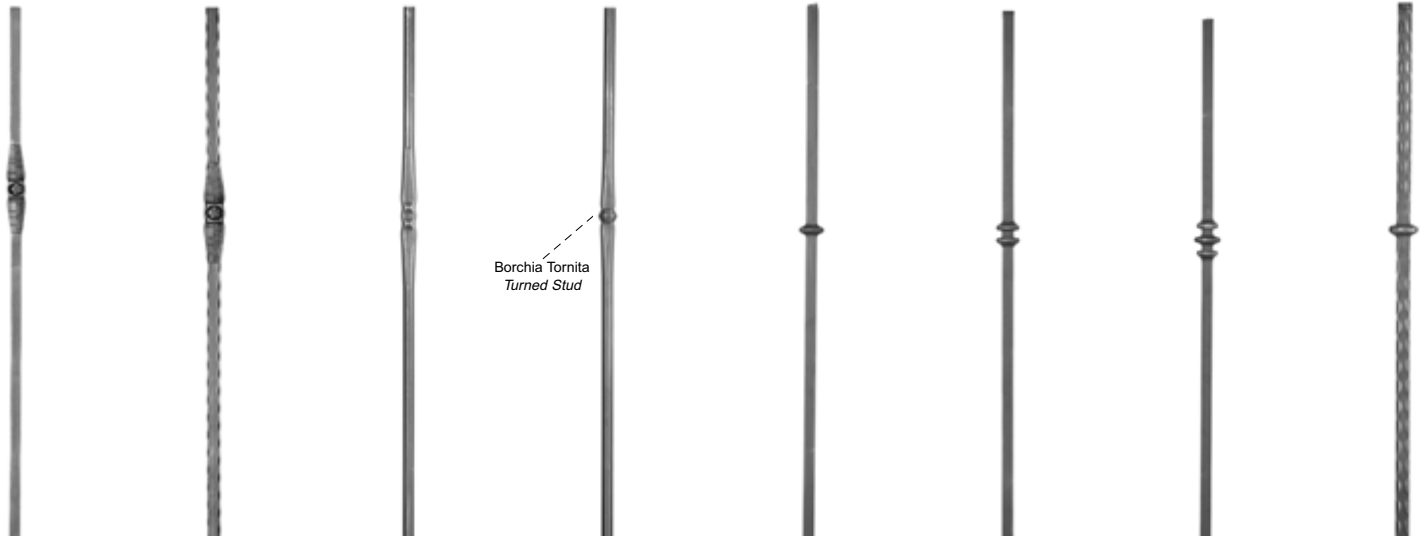

Borchia Tornita
Turned Stud

H.1200 mm.
Art. 11.053.25 □ 25
Art. 11.053.26 □ 30

Martellato / Hammered
H.1200 mm.
Art. 11.053.27 □ 25
Art. 11.053.28 □ 30

Tondo / Round
H.1200 mm.
Art. 11.053.29 Ø 25

Tondo / Round
H.1200 mm.
Art. 11.053.30 Ø 25

H.1200 mm.
Art. 11.053.31 □ 25
Art. 11.053.32 □ 30

H.1200 mm.
Art. 11.053.33 □ 25
Art. 11.053.34 □ 30

H.1200 mm.
Art. 11.053.35 □ 25
Art. 11.053.36 □ 30

Martellato / Hammered
H.1200 mm.
Art. 11.053.37 □ 25
Art. 11.053.38 □ 30

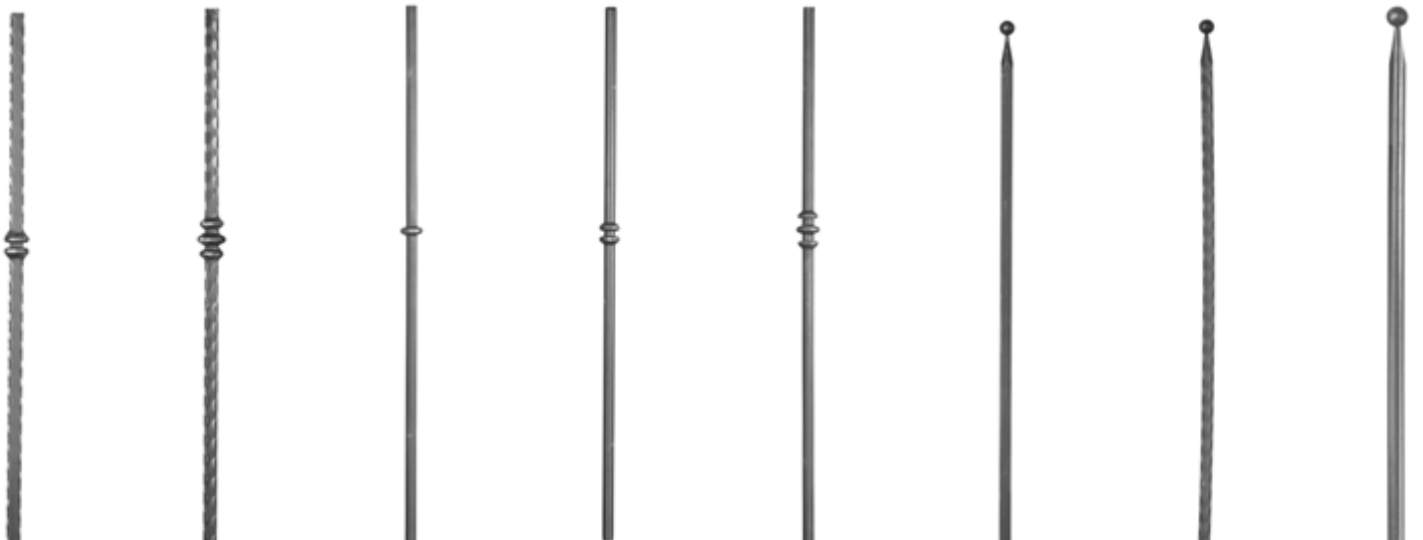

Martellato / Hammered
H.1200 mm.
Art. 11.053.39 □ 25
Art. 11.053.40 □ 30

Martellato / Hammered
H.1200 mm.
Art. 11.053.41 □ 25
Art. 11.053.42 □ 30

Tondo / Round
H.1200 mm.
Art. 11.053.43 Ø 25
Art. 11.053.44 Ø 30

Tondo / Round
H.1200 mm.
Art. 11.053.45 Ø 25
Art. 11.053.46 Ø 30

Tondo / Round
H.1200 mm.
Art. 11.053.47 Ø 25
Art. 11.053.48 Ø 30

H.1200 mm.
Art. 11.053.49 □ 25
Art. 11.053.50 □ 30

Martellato / Hammered
H.1200 mm.
Art. 11.053.51 □ 25
Art. 11.053.52 □ 30

Tondo / Round
H.1200 mm.
Art. 11.053.53 Ø 25
Art. 11.053.54 Ø 30

Tutte le parti di questo catalogo - foto comprese - sono di proprietà Euro-Fer. La riproduzione, anche parziale, è vietata in ogni forma e con ogni mezzo. / Every part of this catalogue - photos included - is Euro-Fer's property. All forms of copying are strictly prohibited.



H.1200 mm.
Art. 11.053.55 □ 25
Art. 11.053.56 □ 30

Martellato / *Hammered*
H.1200 mm.
Art. 11.053.57 □ 25
Art. 11.053.58 □ 30

Tondo / *Round*
H.1200 mm.
Art. 11.053.59 Ø 25
Art. 11.053.60 Ø 30

H.1200 mm.
Art. 11.053.61 □ 25
Art. 11.053.62 □ 30

Martellato / *Hammered*
H.1200 mm.
Art. 11.053.63 □ 25
Art. 11.053.64 □ 30

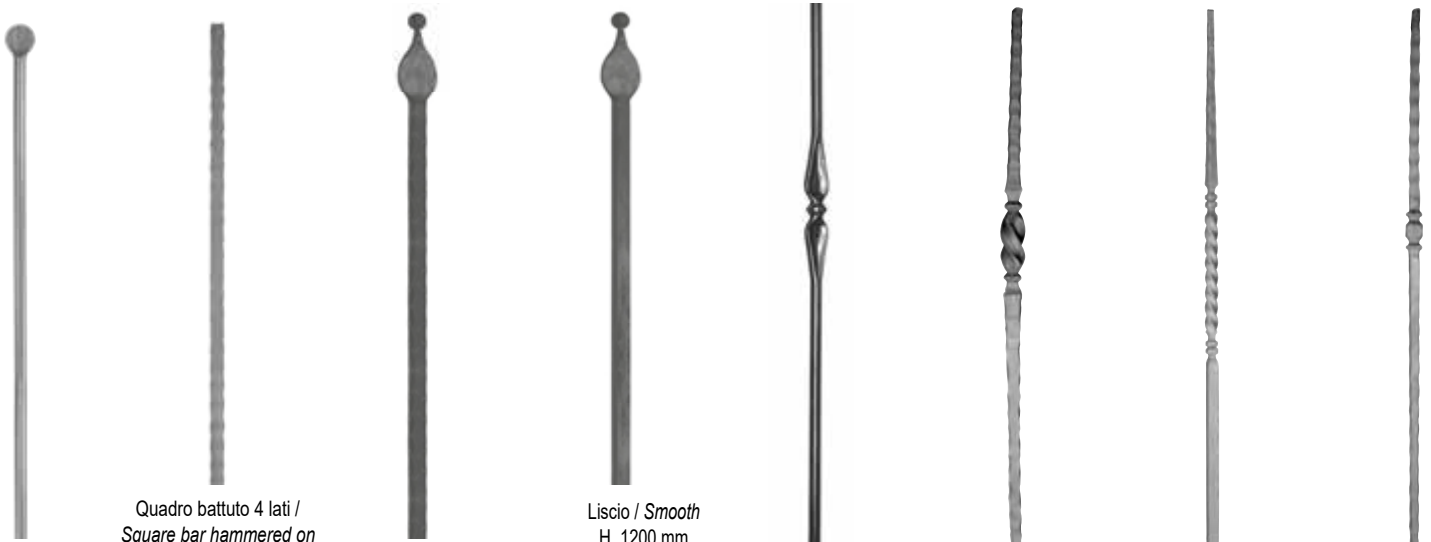

Tondo / *Round*
H.1200 mm.
Art. 11.053.65 Ø 25
Art. 11.053.66 Ø 30

Quadro battuto 4 lati /
Square bar hammered on 4 sides
H.1200 mm.
Art. 11.053.67 □ 25 circa
Art. 11.053.68 □ 30 circa

H. 1200 mm
Martellato / *Hammered*
Art. 11.053.69 □ 30x30
Art. 11.053.70 □ 25x25

Liscio / *Smooth*
H. 1200 mm
Art. 11.053.71 □ 30x30
Art. 11.053.72 □ 25x25
Art. 11.053.73 Ø 30
Art. 11.053.74 Ø 25

Liscio / *Smooth*
H.1200 mm
Art. 11.053.90
Ø 25 circa

H.1200 mm.
Art. 11.054
□ 25 circa

H.1200 mm.
Art. 11.055
□ 25 circa

H.1200 mm.
Art. 11.056
□ 25 circa



H.1200 mm.
Art. 11.057 □ 25 circa
Art. 11.058 □ 30 circa

H.1200 mm.
Art. 11.059 □ 25 circa
Art. 11.060 □ 30 circa

H.1200 mm.
Art. 11.059.P
□ 25 circa

H.1200 mm.
Art. 11.061 □ 25 circa
Art. 11.062 □ 30 circa

H.1200 mm.
Art. 11.063
□ 25 circa

H.1200 mm.
Art. 11.064
□ 25 circa

H.1200 mm.
Art. 11.065
□ 25 circa

H.1200 mm.
Art. 11.066
□ 25 circa

Tutte le parti di questo catalogo - foto comprese - sono di proprietà Euro-Fer. La riproduzione, anche parziale, è vietata in ogni forma e con ogni mezzo. / Every part of this catalogue - photos included - is Euro-Fer's property. All forms of copying are strictly prohibited.

ELEMENTI IN FERRO FORGIATO E CAPISALDI
FORGED BARS AND POSTS



H.1200 mm.
Art. 11.067
□ 25 circa



H.1200 mm
Art. 11.067.01
□ 25 circa



FIGURA IN TONDO
ROUND MOTIF

H.1200 mm.
Art. 11.068
□ 25 mm



FIGURA IN QUADRO
SQUARE MOTIF

H.1200 mm.
Art. 11.068.01
□ 25 mm



H.1200 mm.
Art. 11.069
□ 30 circa



H.1200 mm.
Art. 11.070
□ 25 mm



Smussato / Blunted
H.1200 mm
Art. 11.070.01
□ 25 mm ca.



H.1200 mm.
Art. 11.071
□ 25 mm



Forgiato / Forged
H.1200 mm
Art. 11.071.01
□ 25 circa



H.1200 mm.
Art. 11.072
□ 25 mm



H.1200 mm.
Art. 11.073
□ 25 mm



Martellato / Hammered
H.1200 mm.
Art. 11.074
□ 25 mm



Liscio / Smooth
H.1200 mm.
Art. 11.075
□ 25 mm



H.240 x L.200 mm
Art. 11.077.01 □ 40 mm ca.



Tondo Lavorato / Round Hammered
H.1100 X L.400 mm.
Art. 11.077
□ 30 mm



Art. 11.078



Art. 11.079



H.1100 x L.480 mm
Art. 11.080

Tutte le parti di questo catalogo - foto comprese - sono di proprietà Euro-Fer. La riproduzione, anche parziale, è vietata in ogni forma e con ogni mezzo. / Every part of this catalogue - photos included - is Euro-Fer's property. All forms of copying are strictly prohibited.



H.160 mm.
Art. 11.100
□ 14 mm circa



H.160 mm.
Art. 11.101
□ 14 mm circa



H.160 mm.
Art. 11.102
Ø 12 mm circa



H.200 mm.
Art. 11.150
□ 24 mm circa



Forgiato / Forged
L.3000 mm.
Art.11.200 Ø 12 c.a.
Art.11.201 Ø 14 c.a.

Art.11.203 Ø 16 c.a.
Art.11.207 Ø 20 c.a.
Art.11.208 Ø 25 c.a.
Art.11.209 Ø 30 c.a.



Forgiato / Forged
L.3000 mm.
Art.11.210 □ 12 c.a.
Art.11.211 □ 14 c.a.



Rose Collection
CRYSTALS FROM
SWAROVSKI®

www.rosecollection.it

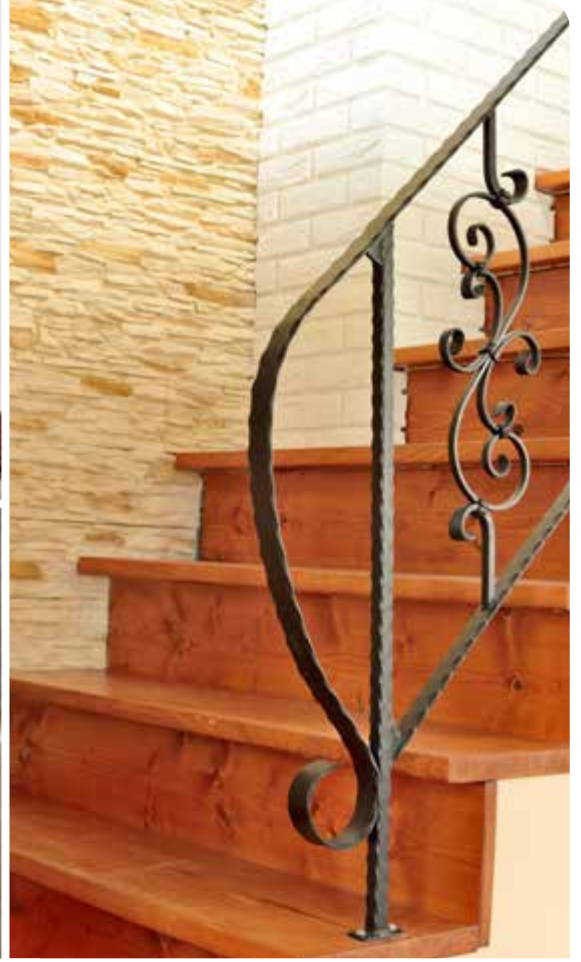



H.3000 mm.		H.6000 mm.	
Art. 12.001	≠ 25 X 6	Art. 12.007	≠ 25 X 6
Art. 12.002	≠ 25 X 8	Art. 12.008	≠ 25 X 8
Art. 12.003	≠ 30 X 6	Art. 12.009	≠ 30 X 6
Art. 12.004	≠ 30 X 8	Art. 12.010	≠ 30 X 8
Art. 12.004.01	≠ 35 X 8	Art. 12.010.01	≠ 35 X 8
Art. 12.005	≠ 40 X 8	Art. 12.011	≠ 40 X 8
Art. 12.006	≠ 50 X 10	Art. 12.012	≠ 50 X 10
Art. 12.006.01	≠ 20 X 5	Art. 12.012.01	≠ 20 X 5
Art. 12.006.02	≠ 20 X 6	Art. 12.012.02	≠ 20 X 6
Art. 12.006.03	≠ 20 X 8	Art. 12.012.03	≠ 20 X 8
Art. 12.006.04	≠ 25 X 10	Art. 12.012.04	≠ 25 X 10
Art. 12.006.05	≠ 25 X 12	Art. 12.012.05	≠ 25 X 12
Art. 12.006.06	≠ 30 X 4	Art. 12.012.06	≠ 30 X 4
Art. 12.006.07	≠ 30 X 10	Art. 12.012.07	≠ 30 X 10
Art. 12.006.08	≠ 30 X 12	Art. 12.012.08	≠ 30 X 12
Art. 12.006.09	≠ 35 X 10	Art. 12.012.09	≠ 35 X 10
Art. 12.006.10	≠ 40 X 6	Art. 12.012.10	≠ 40 X 6
Art. 12.006.11	≠ 40 X 10	Art. 12.012.11	≠ 40 X 10
Art. 12.006.12	≠ 50 X 8	Art. 12.012.12	≠ 50 X 8
Art. 12.006.13	≠ 100 X 10	Art. 12.012.13	≠ 100 X 10
Art. 12.006.14	≠ 100 X 8	Art. 12.012.14	≠ 100 X 8
Art. 12.006.15	≠ 100 X 6	Art. 12.012.15	≠ 100 X 6
Art. 12.006.16	≠ 70 X 6	Art. 12.012.16	≠ 70 X 6
Art. 12.006.17	≠ 50 X 6	Art. 12.012.17	≠ 50 X 6
Art. 12.006.18	≠ 60 X 6	Art. 12.012.18	≠ 60 X 6

Martellato su due spigoli
Hammered on the upper edges

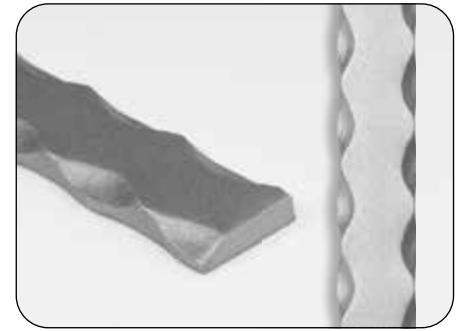

Dimensioni delle partenze:

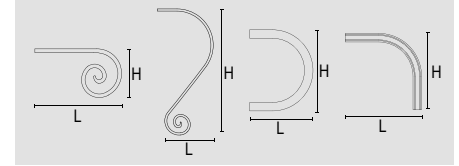

H=100 mm L=200 mm
Art. 12.013 ≠ 40 X 8
Art. 12.014 ≠ 50 X 10
Art. 12.014.01 ≠ 50 X 8



H=130 mm L=200 mm
Art. 12.015 ≠ 40 X 8
Art. 12.016 ≠ 50 X 10
Art. 12.016.01 ≠ 50 X 8



H=100 mm L=200 mm
Art. 12.017 ≠ 40 X 8
Art. 12.018 ≠ 50 X 10



H=180 mm L=200 mm
Art. 12.018.01 ≠ 40 X 8



H=450 mm L=140 mm
Art. 12.019 ≠ 40 X 8



H=460 mm L=140 mm
Art. 12.020 ≠ 40 X 8



H=650 mm L=250 mm
Art. 12.021 ≠ 40 X 8
Art. 12.022 ≠ 50 X 10
Art. 12.022.02 ≠ 50 X 8



H=860 mm L=190 mm
Art. 12.022.01 ≠ 40 X 8
Art. 12.022.03 ≠ 50 X 10



H.400 X L.400 mm.
Art. 12.023 ≠ 25 X 8
Art. 12.024 ≠ 30 X 8
Art. 12.025 ≠ 40 X 8
Art. 12.025.01 ≠ 35 X 8
Art. 12.025.02 ≠ 50 X 8



H.200 X L.200 mm.
Art. 12.026 ≠ 25 X 8 (mis. int. 130)
Art. 12.027 ≠ 30 X 8 (mis. int. 125)
Art. 12.028 ≠ 40 X 8 (mis. int. 120)

Tutte le parti di questo catalogo - foto comprese - sono di proprietà Euro-Fer. La riproduzione, anche parziale, è vietata in ogni forma e con ogni mezzo. / Every part of this catalogue - photos included - is Euro-Fer's property. All forms of copying are strictly prohibited.

Martellato su due spigoli e rigato
Hammered on the upper edges and fluted

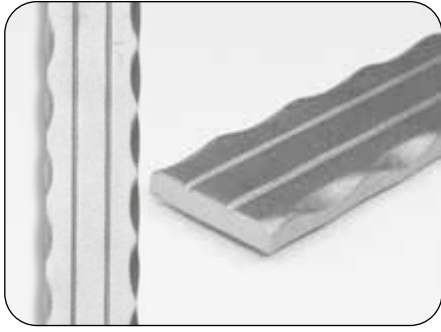

Dimensioni delle partenze:

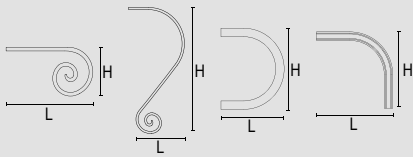

H.3000 mm.

Art. 12.029 \neq 40 X 8
Art. 12.029.01 \neq 50 X 10
Art. 12.029.02 \neq 40 X 6
Art. 12.029.03 \neq 30 X 8

H.6000 mm.

Art. 12.030 \neq 40 X 8
Art. 12.030.01 \neq 50 X 10
Art. 12.030.02 \neq 40 X 6
Art. 12.030.03 \neq 30 X 8

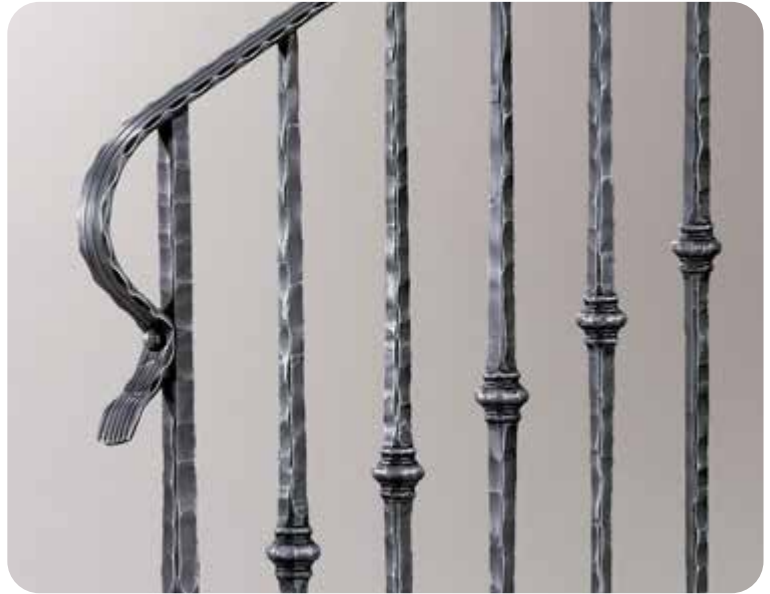

H=460 mm L=140 mm
Art. 12.031 \neq 40 X 8



H=100 mm L=200 mm
Art. 12.032 \neq 40 X 8
Art. 12.032.02 \neq 50 X 10



H=180 mm L=200 mm
Art. 12.032.01 \neq 40 X 8
Art. 12.032.03 \neq 50 X 10



H=450 mm L=140 mm
Art. 12.033 \neq 40 X 8



H=650 mm L=250 mm
Art. 12.034 \neq 40 X 8
Art. 12.034.03 \neq 50 X 10



H=860 mm L=190 mm
Art. 12.034.01 \neq 40 X 8
Art. 12.034.04 \neq 50 X 10



H=720 mm L=350 mm
Art. 12.034.02 \neq 40 X 8



H.200 X L.200 mm.
Art. 12.036 \neq 40 X 8 (mis. int. 120)



H.400 X L.400 mm.
Art. 12.035 \neq 40 X 8
Art. 12.035.01 \neq 50 X 10

Martellato su due spigoli e decorato
Hammered on the upper edges and decorated

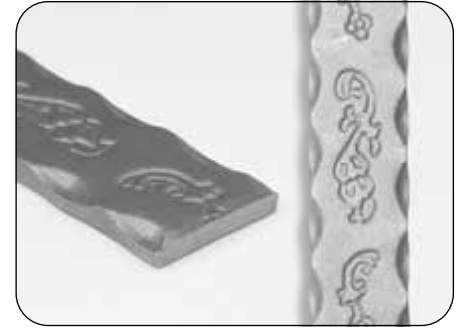

H.3000 mm.
Art. 12.037 \neq 40 X 4
Art. 12.038 \neq 40 X 8
H.6000 mm.
Art. 12.039 \neq 40 X 4
Art. 12.040 \neq 40 X 8

Dimensioni delle partenze:

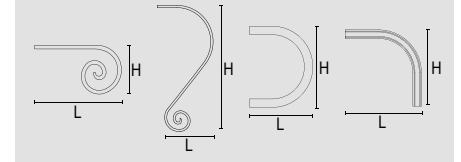

H=180 mm L=200 mm
Art. 12.040.01 \neq 40 X 8



H.200 X L.200 mm.
Art. 12.041 \neq 40 X 8 (mis. int. 120)



H=860 mm L=190 mm
Art. 12.042 \neq 40 X 8



H=100 mm L=200 mm
Art. 12.042.01 \neq 40 X 8



H=460 mm L=140 mm
Art. 12.043 \neq 40 X 8



H=650 mm L=250 mm
Art. 12.043.01 \neq 40 X 8



H.400 X L.400 mm.
Art. 12.044 \neq 40 X 8

Martellato su due spigoli e decorato
Hammered on the upper edges and decorated

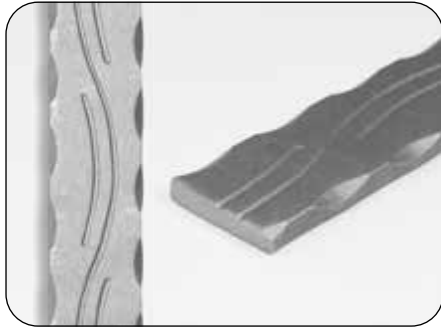

Dimensioni delle partenze:

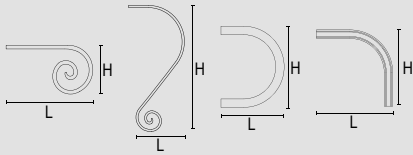

≠ 40 X 8
Art. 12.045 H.3000 mm.
Art. 12.046 H.6000 mm.



H=180 mm L=200 mm
Art. 12.046.01 ≠ 40 X 8



H=100 mm L=200 mm
Art. 12.047 ≠ 40 X 8



H.400 X L.400 mm.
Art. 12.047.01 ≠ 40 X 8



H=460 mm L=140 mm
Art. 12.048 ≠ 40 X 8



H=650 mm L=250 mm
Art. 12.048.01 ≠ 40 X 8



H.200 X L.200 mm.
Art. 12.049 ≠ 40 X 8 (mis. int. 120)

Martellato su due spigoli e decorato
Hammered on the upper edges and decorated



≠ 40 X 8
Art. 12.050 H.3000 mm.
Art. 12.051 H.6000 mm.



H.400 X L.400 mm.
Art. 12.051.01 ≠ 40 X 8



H.200 X L.200 mm.
Art. 12.052.01 ≠ 40 X 8 (mis. int. 120)

Tutte le parti di questo catalogo - foto comprese - sono di proprietà Euro-Fer. La riproduzione, anche parziale, è vietata in ogni forma e con ogni mezzo. / Every part of this catalogue - photos included - is Euro-Fer's property. All forms of copying are strictly prohibited.

Corrimano classico
Classic handrail

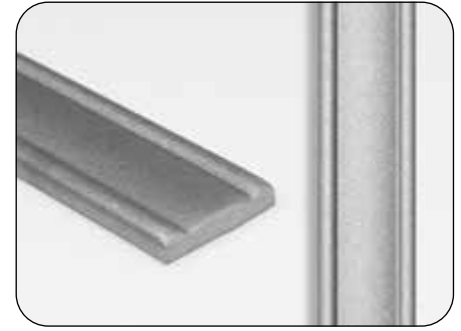

H.6000 mm.
Art. 12.053.02 ≙ 40 X 8

H.3000 mm.
Art. 12.053 ≙ 40 X 8
Art. 12.054 ≙ 50 X 10

Dimensioni delle partenze:

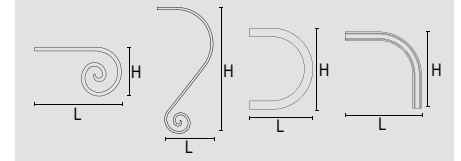

H=450 mm L=140 mm
Art. 12.053.01 ≙ 40 X 8
Art. 12.054.01 ≙ 50 X 10



H.400 X L.400 mm.
Art. 12.055 ≙ 40 X 8
Art. 12.055.01 ≙ 50 X 10



H=100 mm L=200 mm
Art. 12.056 ≙ 40 X 8

H=135 mm L=200 mm
Art. 12.057 ≙ 50 X 10



H=180 mm L=200 mm
Art. 12.056.01 ≙ 40 X 8
Art. 12.057.01 ≙ 50 X 10



H=460 mm L=140 mm
Art. 12.057.02 ≙ 50 X 10
Art. 12.058 ≙ 40 X 8



H.200 X L.200 mm. (mis. int. 120)
Art. 12.058.01 ≙ 40 X 8
Art. 12.058.02 ≙ 50 X 10



Mezzotondo
Half round

H.3000 mm.	
Art. 12.059	≠ 30 X 8
Art. 12.059.02	≠ 25 X 7
Art. 12.060	≠ 30 X 10
Art. 12.061	≠ 35 X 8
Art. 12.062	≠ 35 X 10
Art. 12.063	≠ 40 X 8
Art. 12.064	≠ 40 X 10
Art. 12.065	≠ 40 X 12
Art. 12.066	≠ 50 X 10
Art. 12.067	≠ 50 X 12

H.6000 mm.	
Art. 12.059.01	≠ 30 X 8
Art. 12.060.01	≠ 30 X 10
Art. 12.062.01	≠ 35 X 10
Art. 12.063.01	≠ 40 X 8
Art. 12.064.01	≠ 40 X 10
Art. 12.065.01	≠ 40 X 12
Art. 12.066.01	≠ 50 X 10
Art. 12.067.01	≠ 50 X 12



H.400 X L.400 mm.	
Art. 12.067.02	≠ 30 X 8
Art. 12.067.03	≠ 30 X 10
Art. 12.067.04	≠ 35 X 8
Art. 12.067.05	≠ 35 X 10
Art. 12.067.06	≠ 40 X 8
Art. 12.067.07	≠ 40 X 10
Art. 12.067.08	≠ 40 X 12
Art. 12.067.09	≠ 50 X 10
Art. 12.067.10	≠ 50 X 12

Dimensioni delle partenze:

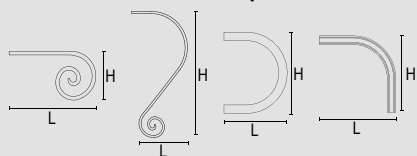

H=35 mm L=200 mm

Art. 12.067.11	≠ 30 X 10
Art. 12.067.12	≠ 35 X 10
Art. 12.067.13	≠ 40 X 8
Art. 12.067.14	≠ 40 X 10
Art. 12.067.15	≠ 40 X 12
Art. 12.067.16	≠ 50 X 10
Art. 12.067.17	≠ 50 X 12



H=100 mm L=200 mm

Art. 12.068	≠ 30 X 8
Art. 12.069	≠ 30 X 10
Art. 12.070	≠ 35 X 8
Art. 12.071	≠ 35 X 10
Art. 12.072	≠ 40 X 8
Art. 12.073	≠ 40 X 10
Art. 12.074	≠ 40 X 10
Art. 12.075	≠ 50 X 10
Art. 12.076	≠ 50 X 12

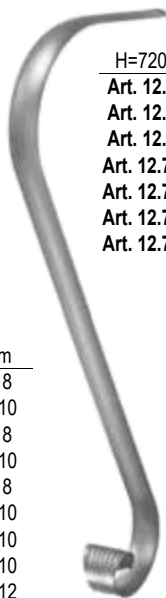

H=720 mm L=350 mm

Art. 12.76.01	≠ 30 X 8
Art. 12.76.02	≠ 35 X 8
Art. 12.76.03	≠ 40 X 8
Art. 12.76.04	≠ 40 X 10
Art. 12.76.05	≠ 40 X 12
Art. 12.76.06	≠ 50 X 12
Art. 12.76.07	≠ 50 X 10

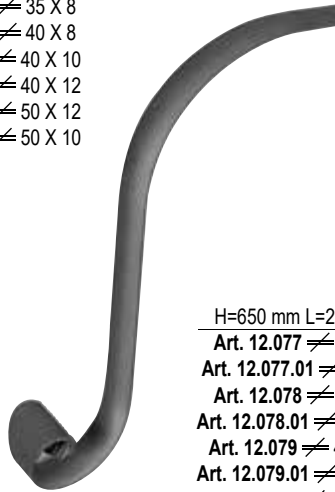

H=650 mm L=250 mm

Art. 12.077	≠ 30 X 8
Art. 12.077.01	≠ 35 X 8
Art. 12.078	≠ 40 X 8
Art. 12.078.01	≠ 40 X 10
Art. 12.079	≠ 40 X 12
Art. 12.079.01	≠ 50 X 12
Art. 12.080	≠ 50 X 10



H.200 X L.200 mm. (mis. int. 120)

Art. 12.080.01	≠ 30 X 8
Art. 12.080.02	≠ 40 X 8
Art. 12.080.03	≠ 50 X 10
Art. 12.080.04	≠ 40 X 10

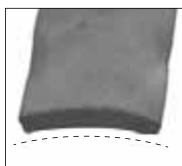
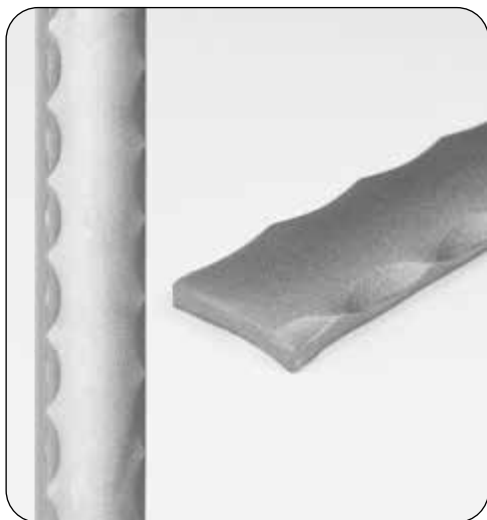
Ferro stonato
Rounded shape

≠ 40 X 8
Art. 12.081 H.3000 mm.
Art. 12.082 H.6000 mm.



H=180 mm L=200 mm
Art. 12.082.01 ≠ 40 X 8



H=100 mm L=200 mm
Art. 12.083 ≠ 40 X 8



H.400 X L.400 mm.
Art. 12.083.01 ≙ 50 X 14
Art. 12.083.02 ≙ 40 X 12
Art. 12.083.03 ≙ 45 X 12
Art. 12.083.04 ≙ 60 X 16



H.3000 mm.
Art. 12.084 ≙ 50 X 14
Art. 12.084.01 ≙ 40 X 12
Art. 12.084.02 ≙ 45 X 12
Art. 12.084.03 ≙ 60 X 16

H.6000 mm.
Art. 12.085 ≙ 50 X 14
Art. 12.085.01 ≙ 40 X 12
Art. 12.085.02 ≙ 45 X 12
Art. 12.085.03 ≙ 60 X 16

Corrimano sagomato
Shaped hand rail

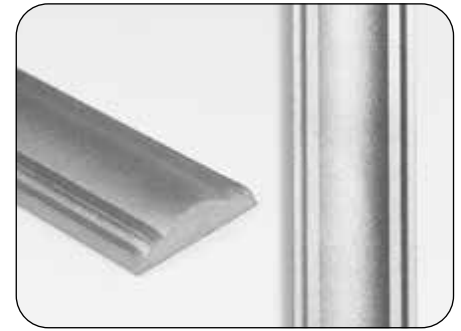

Dimensioni delle partenze:

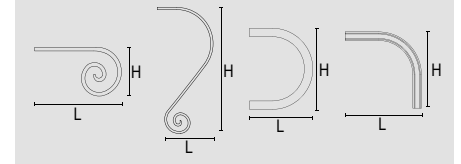

H=330 mm L=190 mm
Art. 12.086 ≙ 50 X 14
Art. 12.086.01 ≙ 40 X 12
Art. 12.086.02 ≙ 45 X 12
Art. 12.086.03 ≙ 60 X 16



H=300 mm L=110 mm
Art. 12.086.04 ≙ 50 X 14
Art. 12.086.05 ≙ 40 X 12
Art. 12.086.06 ≙ 45 X 12
Art. 12.086.07 ≙ 60 X 16



H=35 mm L=200 mm
Art. 12.086.08 ≙ 50 X 14
Art. 12.086.09 ≙ 40 X 12
Art. 12.086.10 ≙ 45 X 12
Art. 12.086.11 ≙ 60 X 16



H=100 mm L=200 mm
Art. 12.086.12 ≙ 50 X 14
Art. 12.086.13 ≙ 50 X 12
Art. 12.086.14 ≙ 45 X 12
Art. 12.086.15 ≙ 60 X 16



H=180 mm L=200 mm
Art. 12.087 ≙ 50 X 14
Art. 12.087.01 ≙ 40 X 12
Art. 12.087.01 ≙ 45 X 12
Art. 12.087.01 ≙ 60 X 16



H=650 mm L=250 mm
Art. 12.087.04 ≙ 50 X 14
Art. 12.087.05 ≙ 40 X 12
Art. 12.087.06 ≙ 45 X 12
Art. 12.087.07 ≙ 60 X 16



Tutte le parti di questo catalogo - foto comprese - sono di proprietà Euro-Fer. La riproduzione, anche parziale, è vietata in ogni forma e con ogni mezzo. / Every part of this catalogue - photos included - is Euro-Fer's property. All forms of copying are strictly prohibited.

Corrimano rustico
Rustic handrail

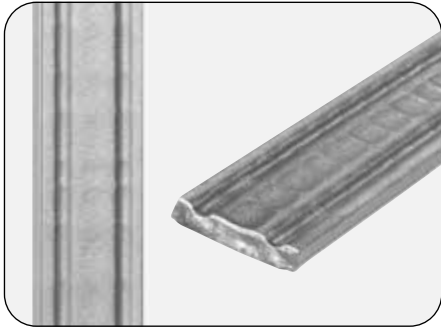

Dimensioni delle partenze:

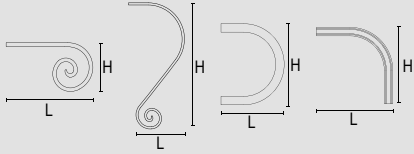

$\neq 40 \times 8$
Art. 12.087.08 H.3000 mm.
Art. 12.087.09 H.6000 mm.

H=100 mm L=200 mm
Art. 12.087.10 $\neq 40 \times 8$

H=180 mm L=200 mm
Art. 12.087.11 $\neq 40 \times 8$

H=860 mm L=190 mm
Art. 12.087.12 $\neq 40 \times 8$

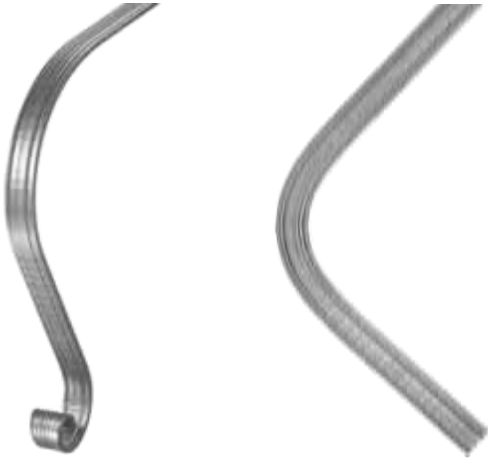

H=650 mm L=250 mm
Art. 12.087.13 $\neq 40 \times 8$

H.400 X L.400 mm.
Art. 12.087.14 $\neq 40 \times 8$



Battuto su due spigoli superiori (mod. DUNE)
Hammered on the upper edges (mod. DUNE)

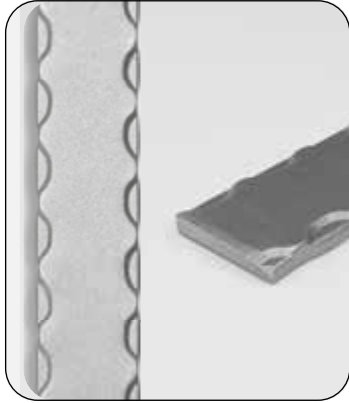

≠ 40 X 8
Art. 12.087.15 H.3000 mm.
Art. 12.087.16 H.6000 mm.

H=100 mm L=200 mm
Art. 12.087.17 ≠ 40 X 8

H=180 mm L=200 mm
Art. 12.087.18 ≠ 40 X 8

H=650 mm L=250 mm
Art. 12.087.19 ≠ 40 X 8

H=860 mm L=190 mm
Art. 12.087.20 ≠ 40 X 8

H.400 X L.400 mm.
Art. 12.087.21 ≠ 40 X 8

Dimensioni delle partenze:

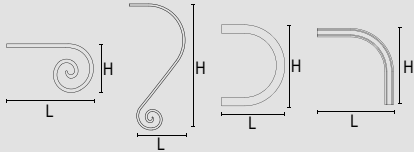

Martellato su due spigoli e decorato
Hammered on the upper edges and decorated

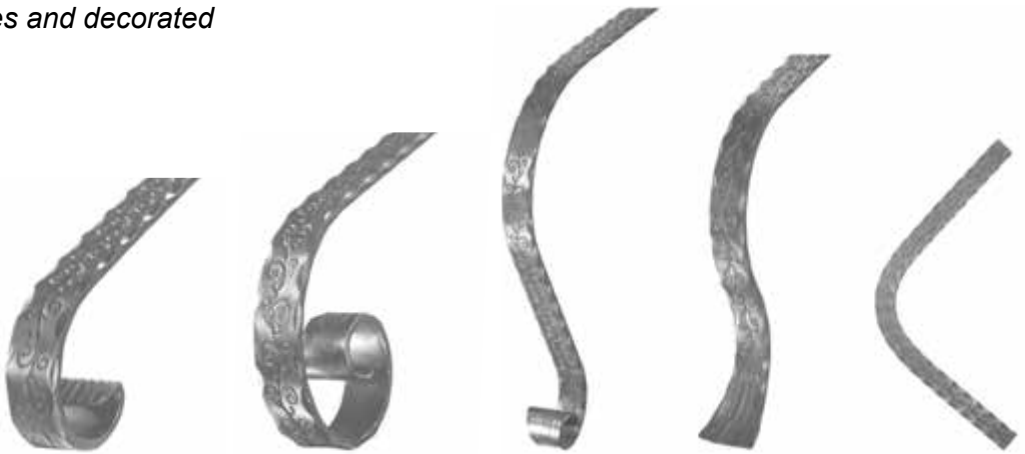

≠ 40 X 8
Art. 12.087.22 H.3000 mm.
Art. 12.087.23 H.6000 mm.

H=100 mm L=200 mm
Art. 12.087.24 ≠ 40 X 8

H=180 mm L=200 mm
Art. 12.087.25 ≠ 40 X 8

H=650 mm L=250 mm
Art. 12.087.26 ≠ 40 X 8

H=460 mm L=140 mm
Art. 12.087.27 ≠ 40 X 8

H.400 X L.400 mm.
Art. 12.087.28 ≠ 40 X 8

Dimensioni delle partenze:

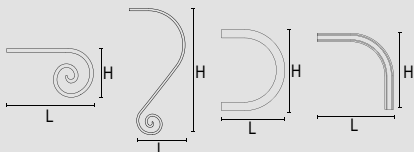

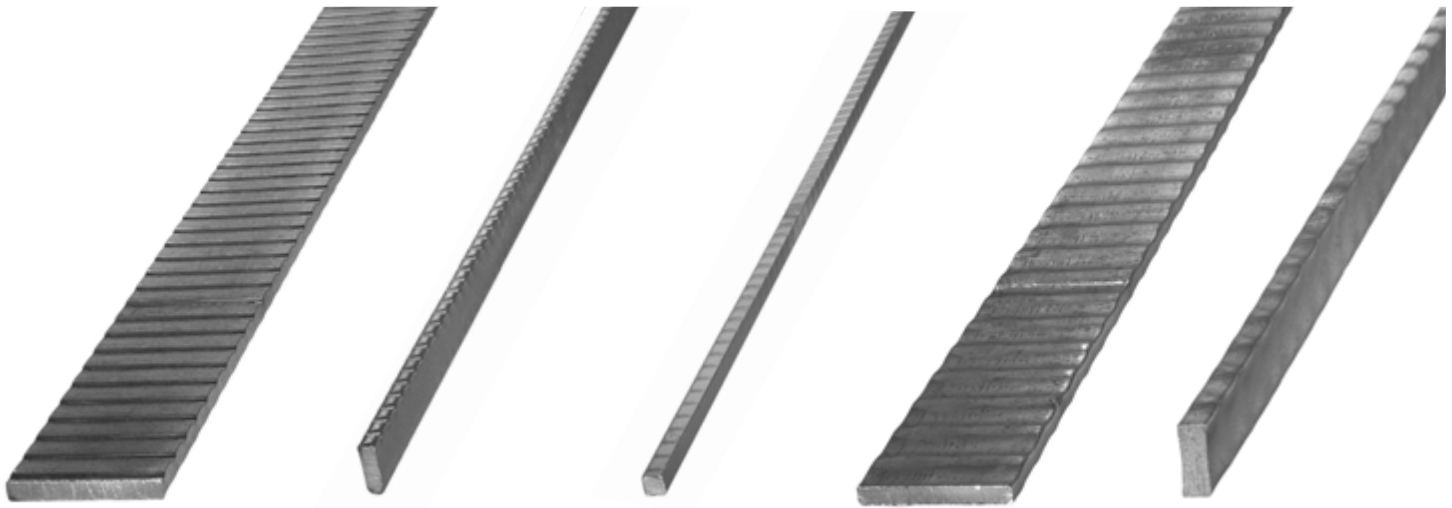

Piatto mod. scala battuto sopra e sotto / Flat scala model beaten over and below (2 sides)

H.3000 mm.

Art. 12.088	≠	30 X 8
Art. 12.089	≠	40 X 8
Art. 12.090	≠	40 X 10
Art. 12.091	≠	50 X 10
Art. 12.091.01	≠	60 X 8

H.6000 mm.

Art. 12.092	≠	30 X 8
Art. 12.093	≠	40 X 8
Art. 12.094	≠	40 X 10
Art. 12.095	≠	50 X 10
Art. 12.095.01	≠	60 X 8

Piatto mod. scala battuto sugli spessori / Flat scala model beaten on the thicknesses (2 sides)

H.3000 mm.

Art. 12.095.02	≠	10 X 5
Art. 12.095.03	≠	12 X 6
Art. 12.095.04	≠	14 X 6
Art. 12.095.05	≠	16 X 6
Art. 12.095.06	≠	20 X 6
Art. 12.095.30	≠	16 X 8

H.6000 mm.

Art. 12.095.07	≠	14 X 6
Art. 12.095.08	≠	16 X 6
Art. 12.095.09	≠	20 X 6
Art. 12.095.31	≠	16 X 8

Quadro mod. scala battuto sopra e sotto / Square scala model beaten over and below (2 sides)

H.3000 mm.

Art. 12.095.10	□	8
----------------	---	---

Piatto battuto sopra e sotto / Flat bar beaten over and below (2 sides)

H.3000 mm.

Art. 12.095.11	≠	60 X 8
----------------	---	--------

H.6000 mm.

Art. 12.095.12	≠	60 X 8
----------------	---	--------

Piatto battuto sugli spessori / Flat bar beaten on the thickness (2 sides)

H.3000 mm.

Art. 12.095.13	≠	25 X 10
Art. 12.095.14	≠	30 X 10

H.6000 mm.

Art. 12.095.15	≠	25 X 10
Art. 12.095.16	≠	30 X 10

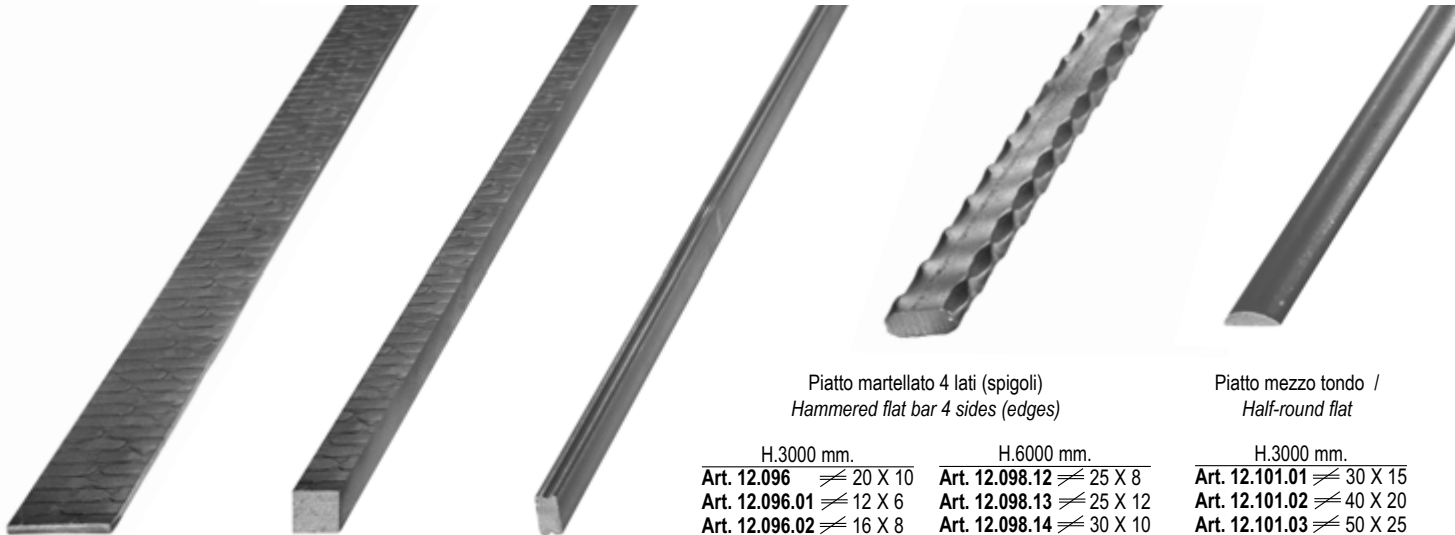

Piatto modello mattone battuto sopra e sotto / Flat brick model beaten over and below (2 sides)

H.3000 mm.

Art. 12.095.17	≠	20 X 4
Art. 12.095.18	≠	25 X 4
Art. 12.095.19	≠	25 X 6
Art. 12.095.20	≠	25 X 8
Art. 12.095.21	≠	30 X 4
Art. 12.095.22	≠	30 X 6
Art. 12.095.23	≠	30 X 8
Art. 12.095.24	≠	40 X 4
Art. 12.095.25	≠	40 X 6
Art. 12.095.26	≠	40 X 8

Quadro modello mattone su 2 lati / Square brick model beaten on 2 sides

H.3000 mm.

Art. 12.095.27	□	12
Art. 12.095.32	□	14

Piatto rigato sugli spessori / Flat bar fluted on the thickness (2 sides)

H.3000 mm.

Art. 12.095.28	≠	12 X 6
Art. 12.095.29	≠	16 X 8

Piatto martellato 4 lati (spigoli) / Hammered flat bar 4 sides (edges)

H.3000 mm.

Art. 12.096	≠	20 X 10
Art. 12.096.01	≠	12 X 6
Art. 12.096.02	≠	16 X 8
Art. 12.097	≠	25 X 10
Art. 12.098	≠	30 X 8
Art. 12.098.01	≠	16 X 5
Art. 12.098.02	≠	20 X 6
Art. 12.098.03	≠	25 X 6
Art. 12.098.04	≠	25 X 8
Art. 12.098.05	≠	25 X 12
Art. 12.098.06	≠	30 X 10
Art. 12.098.07	≠	30 X 20
Art. 12.098.08	≠	35 X 8
Art. 12.098.09	≠	35 X 10
Art. 12.098.10	≠	40 X 8
Art. 12.098.11	≠	40 X 10
Art. 12.098.20	≠	35 X 15
Art. 12.098.21	≠	30 X 6
Art. 12.098.22	≠	50 X 8
Art. 12.098.26	≠	30 X 15

H.6000 mm.

Art. 12.098.12	≠	25 X 8
Art. 12.098.13	≠	25 X 12
Art. 12.098.14	≠	30 X 10
Art. 12.098.15	≠	30 X 20
Art. 12.098.16	≠	35 X 8
Art. 12.098.17	≠	35 X 10
Art. 12.098.18	≠	40 X 8
Art. 12.098.19	≠	40 X 10
Art. 12.098.23	≠	35 X 15
Art. 12.098.24	≠	30 X 6
Art. 12.098.25	≠	50 X 8
Art. 12.099	≠	20 X 10
Art. 12.100	≠	25 X 10
Art. 12.101	≠	30 X 8
Art. 12.098.27	≠	30 X 15

Piatto mezzo tondo / Half-round flat

H.3000 mm.

Art. 12.101.01	≠	30 X 15
Art. 12.101.02	≠	40 X 20
Art. 12.101.03	≠	50 X 25
Art. 12.101.04	≠	60 X 30
Art. 12.101.09	≠	16 X 8
Art. 12.101.10	≠	20 X 10
Art. 12.101.11	≠	35 X 15
Art. 12.101.12	≠	40 X 15

H.6000 mm.

Art. 12.101.05	≠	30 X 15
Art. 12.101.06	≠	40 X 20
Art. 12.101.07	≠	50 X 25
Art. 12.101.08	≠	60 X 30
Art. 12.101.13	≠	16 X 8
Art. 12.101.14	≠	20 X 10
Art. 12.101.15	≠	35 X 15
Art. 12.101.16	≠	40 X 15
Art. 12.101.20	≠	60 X 20

BARRE PER FASCETTE / COLLAR BARS



- H.4000 mm.
Art. 12.108 \neq 14 X 4
- H.3000 mm.
Art. 12.108.01 \neq 25 X 8
Art. 12.108.02 \neq 30 X 8
Art. 12.108.05 \neq 40 X 8
- H.6000 mm.
Art. 12.108.03 \neq 25 X 8
Art. 12.108.04 \neq 30 X 8
Art. 12.108.06 \neq 40 X 8
Art. 12.108.08 \neq 40 X 13



- H.4000 mm.
Art. 12.109 \neq 18 X 6



- H.4000 mm.
Art. 12.110 \neq 18 X 5



- H.4000 mm.
Art. 12.111 \neq 14 X 4

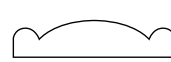

- H.3000 mm.
Art. 12.112 \neq 10 X 3
Art. 12.113 \neq 12 X 3
Art. 12.114 \neq 14 X 3
Art. 12.115 \neq 16 X 4
Art. 12.116 \neq 20 X 4



- H.4000 mm.
Art. 12.117 \neq 11 X 3
Art. 12.118 \neq 14 X 4
Art. 12.119 \neq 16 X 5
Art. 12.120 \neq 21 X 6

NEW

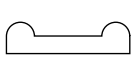

- H. 3000 mm.
Art. 12.108.10 \neq 25 X 8
Art. 12.108.11 \neq 30 X 8

Barra Tacchettato/Scala / Collar bar Scala Model

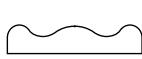

- H.3000 mm.
Art. 12.120.02 \neq 15 X 3



- H.3000 mm.
Art. 12.120.03 \neq 20 X 4



- \neq 14 X 4 mm.
Art. 12.122 2 \neq 12 X 6
Art. 12.123 2 \neq 12 X 6
+ 1 \square 12 X 12
Art. 12.124 2 \square 8 X 8



- \neq 18 X 6 mm.
Art. 12.125 1 \square 20 X 20



- \neq 14 X 4 mm.
Art. 12.126 2 \neq 12 X 6
Art. 12.127 2 \neq 12 X 6
+ 1 \square 12 X 12
Art. 12.128 2 \square 8 X 8
Art. 12.129 3 \square 8 X 8



- \neq 18 X 5 mm.
Art. 12.130 2 \neq 12 X 6
+ 1 \square 12 X 12

- Art. 12.130.01 1 \neq 12 X 6
+ 1 \square 12 X 12
Art. 12.130.02 1 \neq 14 X 6
+ 1 \square 14 X 14
Art. 12.130.03 2 \neq 14 X 6
+ 1 \square 14 X 14
Art. 12.130.04 1 \neq 16 X 6
+ 1 \square 16 X 16
Art. 12.130.05 2 \neq 16 X 6
+ 1 \square 16 X 16



- \neq 14 X 4 mm.
Art. 12.131 2 \neq 20 X 6
Art. 12.132 3 \neq 20 X 4
Art. 12.133 3 \neq 20 X 6
Art. 12.134 2 \neq 12 X 6
+ 1 \square 12 X 12

- Art. 12.134.01 1 \neq 12 X 6
+ 1 \square 12 X 12
Art. 12.134.02 1 \neq 14 X 6
+ 1 \square 14 X 14
Art. 12.134.03 2 \neq 14 X 6
+ 1 \square 14 X 14
Art. 12.134.04 1 \neq 16 X 6
+ 1 \square 16 X 16
Art. 12.134.05 2 \neq 16 X 6
+ 1 \square 16 X 16

Rigato e martellato
su 4 facce
*Hammered and Fluted
on 4 sides*

H.3000 mm.

Art. 12.189 □ 12 X 12
Art. 12.190 □ 14 X 14

H.6000 mm.

Art. 12.191 □ 12 X 12
Art. 12.192 □ 14 X 14

Barre in Spigolo
Edged Bar

H.3000 mm.

Art. 12.192.01 □ 12 X 12
Art. 12.192.02 □ 14 X 14
Art. 12.192.03 □ 16 X 16
Art. 12.192.04 □ 18 X 18
Art. 12.192.05 □ 20 X 20

H.6000 mm.

Art. 12.192.06 □ 12 X 12
Art. 12.192.07 □ 14 X 14
Art. 12.192.08 □ 16 X 16
Art. 12.192.09 □ 18 X 18
Art. 12.192.10 □ 20 X 20
Art. 12.192.11 □ 25 X 25
Art. 12.192.12 □ 30 X 30

Rigato 4 facce
Fluted 4 faces

H.3000 mm.

Art. 12.193 □ 12 X 12
Art. 12.194 □ 14 X 14
Art. 12.194.01 □ 16 X 16

H.6000 mm.

Art. 12.195 □ 12 X 12
Art. 12.196 □ 14 X 14
Art. 12.194.02 □ 16 X 16

Rigato 2 facce
Fluted 2 faces

H.3000 mm

Art. 12.194.03 □ 12
Art. 12.194.04 □ 14
Art. 12.194.05 □ 16

H.6000 mm

Art. 12.194.06 □ 12
Art. 12.194.07 □ 14
Art. 12.194.08 □ 16

Modello Corteccia
Bark Model

H.3000 mm.

Art. 12.196.01 Ø 14
Art. 12.196.02 Ø 16
Art. 12.196.03 Ø 20
Art. 12.196.04 Ø 22
Art. 12.196.09 Ø 18
Art. 12.196.10 Ø 25
Art. 12.196.11 Ø 30
Art. 12.196.15 Ø 12

H.6000 mm.

Art. 12.196.05 Ø 14
Art. 12.196.06 Ø 16
Art. 12.196.07 Ø 20
Art. 12.196.08 Ø 22
Art. 12.196.12 Ø 18
Art. 12.196.13 Ø 25
Art. 12.196.14 Ø 30
Art. 12.196.16 Ø 12

Modello Corteccia
Bark Model

H.3000 mm

Art. 12.196.50 □ 12
Art. 12.196.51 □ 14
Art. 12.196.52 □ 16

H.6000 mm

Art. 12.196.61 □ 12
Art. 12.196.62 □ 14
Art. 12.196.63 □ 16

Modello Scala
Scala Model

H.3000 mm.

Art. 12.197 □ 12 X 12
Art. 12.198 □ 14 X 14
Art. 12.199 □ 16 X 16
Art. 12.200 □ 18 X 18
Art. 12.201 □ 20 X 20
Art. 12.202 □ 25 X 25
Art. 12.203 □ 30 X 30
Art. 12.204 □ 40 X 40

H.6000 mm.

Art. 12.205 □ 12 X 12
Art. 12.206 □ 14 X 14
Art. 12.207 □ 16 X 16
Art. 12.208 □ 18 X 18
Art. 12.209 □ 20 X 20
Art. 12.210 □ 25 X 25
Art. 12.211 □ 30 X 30
Art. 12.212 □ 40 X 40

Piatto Modello Scala
Flat Scala Model

H.3000 mm.

Art. 12.204.01 ≡ 30 X 20

H.6000 mm.

Art. 12.212.01 ≡ 30 X 20

Quadro battuto 4 lati
Square Bars Hammered on 4 sides

H.3000 mm.

Art. 12.213 □ 12 X 12
Art. 12.214 □ 14 X 14
Art. 12.215 □ 16 X 16
Art. 12.216 □ 18 X 18
Art. 12.217 □ 20 X 20
Art. 12.218 □ 25 X 25
Art. 12.219 □ 30 X 30
Art. 12.220 □ 35 X 35
Art. 12.221 □ 40 X 40

H.6000 mm.

Art. 12.222 □ 12 X 12
Art. 12.223 □ 14 X 14
Art. 12.224 □ 16 X 16
Art. 12.225 □ 18 X 18
Art. 12.226 □ 20 X 20
Art. 12.227 □ 25 X 25
Art. 12.228 □ 30 X 30
Art. 12.229 □ 35 X 35
Art. 12.230 □ 40 X 40

Piatto battuto 2 lati
Flat Bars Hammered on 2 sides

H.3000 mm.

Art. 12.221.01 ≡ 30 X 20

H.6000 mm.

Art. 12.228.01 ≡ 30 X 20

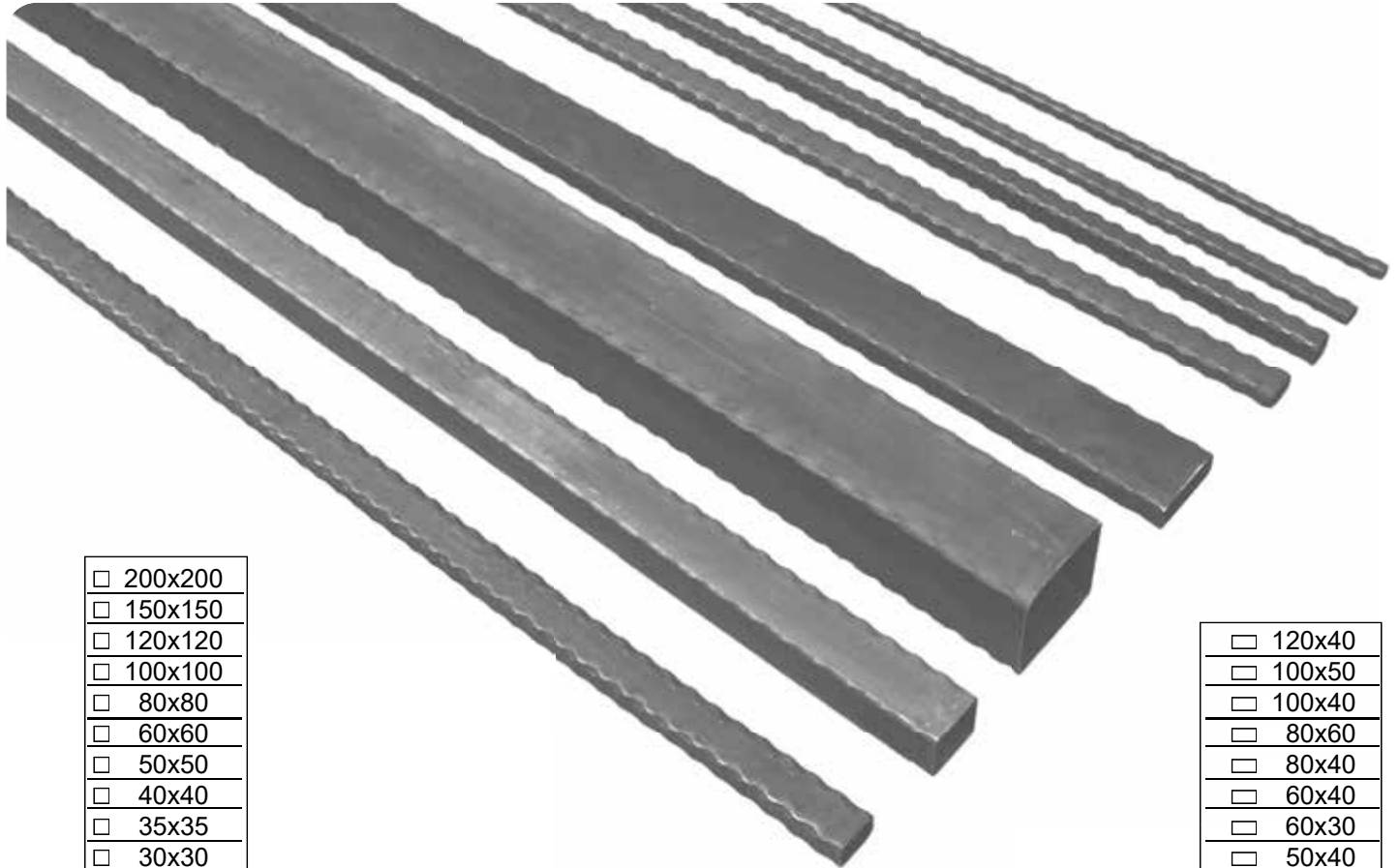
Tubo martellato / *Hammered Tube*

<input type="checkbox"/> 200x200
<input type="checkbox"/> 150x150
<input type="checkbox"/> 120x120
<input type="checkbox"/> 100x100
<input type="checkbox"/> 80x80
<input type="checkbox"/> 60x60
<input type="checkbox"/> 50x50
<input type="checkbox"/> 40x40
<input type="checkbox"/> 35x35
<input type="checkbox"/> 30x30
<input type="checkbox"/> 25x25
<input type="checkbox"/> 20x20
<input type="checkbox"/> 15x15
<input type="checkbox"/> 12x12



<input type="checkbox"/> 120x40
<input type="checkbox"/> 100x50
<input type="checkbox"/> 100x40
<input type="checkbox"/> 80x60
<input type="checkbox"/> 80x40
<input type="checkbox"/> 60x40
<input type="checkbox"/> 60x30
<input type="checkbox"/> 50x40
<input type="checkbox"/> 50x30
<input type="checkbox"/> 40x30
<input type="checkbox"/> 40x20
<input type="checkbox"/> 30x20

200 X 200 X 4 mm.
Art. 12.230.07 H.3000 mm.
Art. 12.230.08 H.6000 mm.

50 X 50 X 2,5 mm.
Art. 12.235 H.3000 mm.
Art. 12.236 H.6000 mm.

120 X 40 X 3 mm.
Art. 12.244.08 H.3000 mm.
Art. 12.244.11 H.6000 mm.

60 X 30 X 2,5 mm.
Art. 12.246.01 H.3000 mm.
Art. 12.246.02 H.6000 mm.

150 X 150 X 4 mm.
Art. 12.230.05 H.3000 mm.
Art. 12.230.06 H.6000 mm.

40 X 40 X 2,5 mm.
Art. 12.237 H.3000 mm.
Art. 12.238 H.6000 mm.

100 X 50 X 3 mm.
Art. 12.244.07 H.3000 mm.
Art. 12.244.10 H.6000 mm.

50 X 40 X 2,5 mm.
Art. 12.247 H.3000 mm.
Art. 12.248 H.6000 mm.

120 X 120 X 3 mm.
Art. 12.230.01 H.3000 mm.
Art. 12.230.02 H.6000 mm.

35 X 35 X 3 mm.
Art. 12.238.01 H.3000 mm.
Art. 12.238.02 H.6000 mm.

100 X 40 X 3 mm.
Art. 12.244.03 H.3000 mm.
Art. 12.244.04 H.6000 mm.

50 X 30 X 2,5 mm.
Art. 12.249 H.3000 mm.
Art. 12.250 H.6000 mm.

100 X 100 X 3 mm.
Art. 12.230.03 H.3000 mm.
Art. 12.230.04 H.6000 mm.

30 X 30 X 2,5 mm.
Art. 12.239 H.3000 mm.
Art. 12.240 H.6000 mm.

80 X 60 X 3 mm.
Art. 12.244.09 H.3000 mm.
Art. 12.244.12 H.6000 mm.

40 X 30 X 2,5 mm.
Art. 12.250.01 H.3000 mm.
Art. 12.250.02 H.6000 mm.

80 X 80 X 2,5 mm.
Art. 12.231 H.3000 mm.
Art. 12.232 H.6000 mm.

25 X 25 X 2,5 mm.
Art. 12.241 H.3000 mm.
Art. 12.242 H.6000 mm.

80 X 40 X 2,5 mm.
Art. 12.244.05 H.3000 mm.
Art. 12.244.06 H.6000 mm.

40 X 20 X 2 mm.
Art. 12.251 H.3000 mm.
Art. 12.252 H.6000 mm.

60 X 60 X 2,5 mm.
Art. 12.233 H.3000 mm.
Art. 12.234 H.6000 mm.

H.3000 mm.
Art. 12.243 20 X 20 X 2
Art. 12.244.01 12 X 12 X 1,5
Art. 12.244.02 15 X 15 X 1,5
H.6000 mm.
Art. 12.244 20 X 20 X 2

60X 40 X 2,5 mm.
Art. 12.245 H.3000 mm.
Art. 12.246 H.6000 mm.

30X 20 X 2 mm.
Art. 12.253 H.3000 mm.
Art. 12.254 H.6000 mm.



H.3000 mm.
Art. 12.261 □ 16 mm



H.3000 mm.
Art. 12.262 □ 15 mm



PROFILO A NUVOLA
'CLOUD' PROFILE

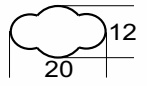

H.4000 mm.
Art. 12.263 ≡ 20 X 12 mm



H.3000 mm
Art. 12.270 ≡ A = 55 / B = 17 / C = 25 mm
Art. 12.270.01 ≡ A = 45 / B = 15 / C = 22 mm

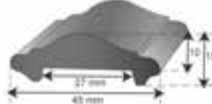

H.3000 mm
Art. 12.271 ≡ 45 X 15



Fuori Produzione
Out of Production



Art. 12.272



Fuori Produzione
Out of Production



Art. 12.272.01

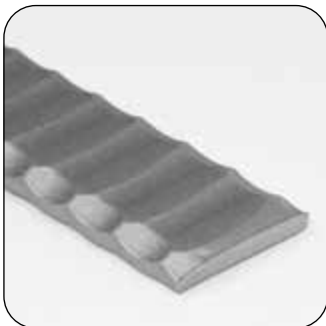

Martellato / Hammered
H.3000 mm.
Art. 12.273 ≡ 40 X 8 mm
H.6000 mm.
Art. 12.273.01 ≡ 40 X 8 mm



Lavorato / Worked
H.3000 mm.
Art.12.274 ≡ 40 x 8 mm



PARTENZone

Stop agli allineamenti e alla saldatura tra partenza e corrimano.

Ecco la prima rampa della tua scala in un unico pezzo già pronta per l'installazione e facilmente adattabile alle tue esigenze con un semplice taglio.

PARTENZone

Stop alignments and welding between start and handrails.

Here is the first flight of your staircase in one piece ready for installation that can easily be adapted to your needs with a simple cut.

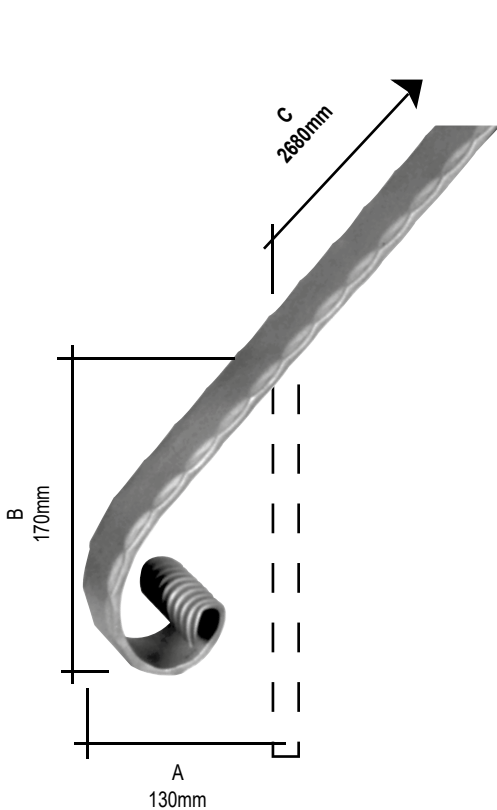
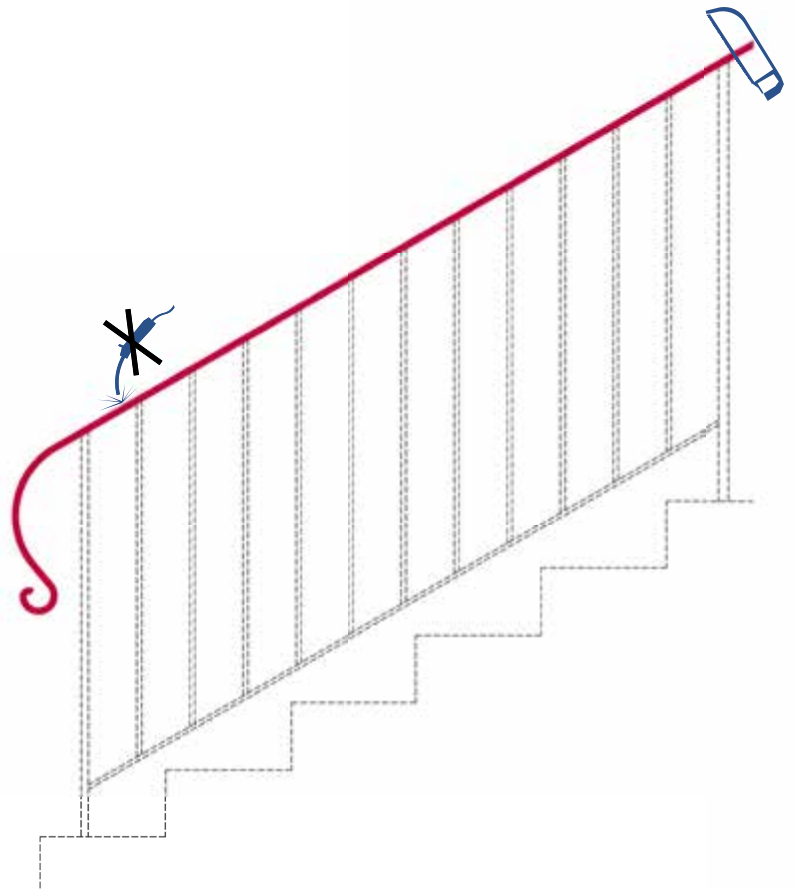

Martellato / Hammered
Art.12.P1.013 \neq 40 x 8 mm

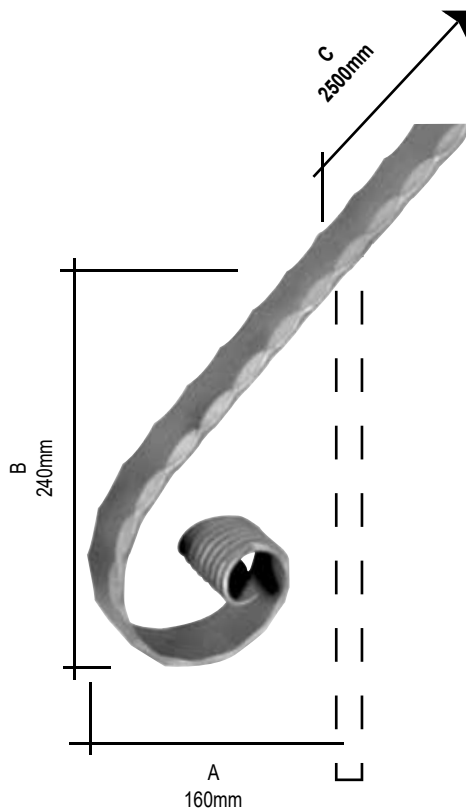

Martellato / Hammered
Art.12.P1.015 \neq 40 x 8 mm

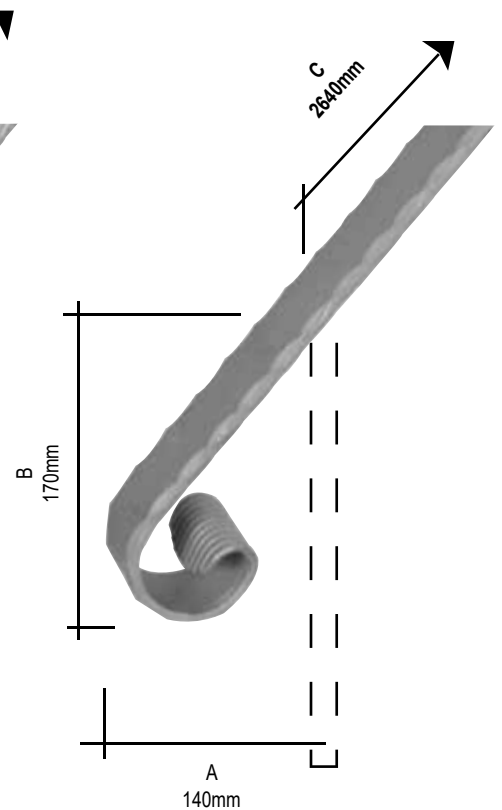

Martellato / Hammered
Art.12.P1.017 \neq 40 x 8 mm
Art.12.P1.018 \neq 50 x 10 mm

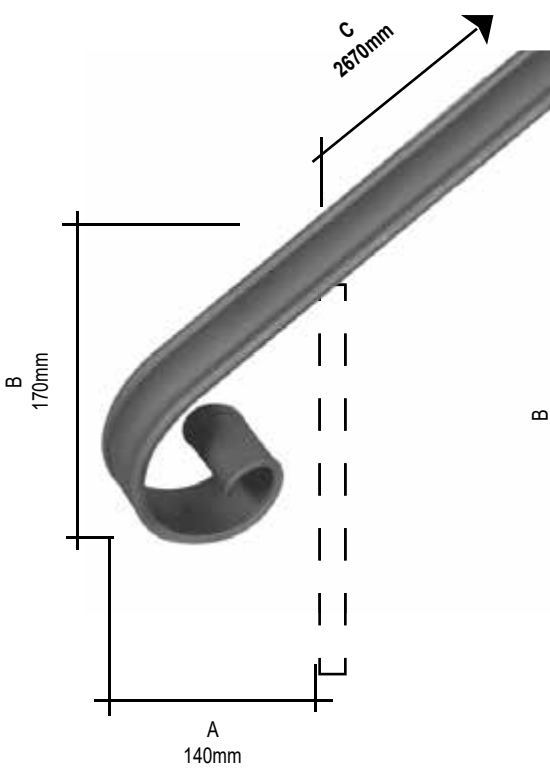

Art.12.P1.056 40 x 8 mm

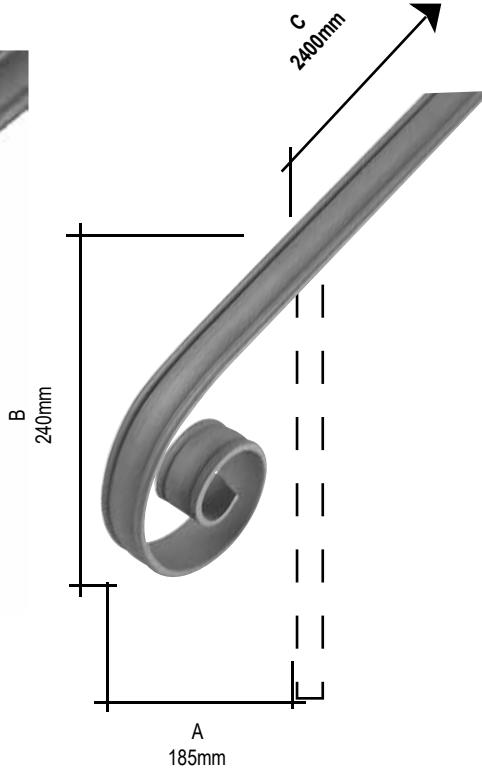

Art.12.P1.056.01 40 x 8 mm

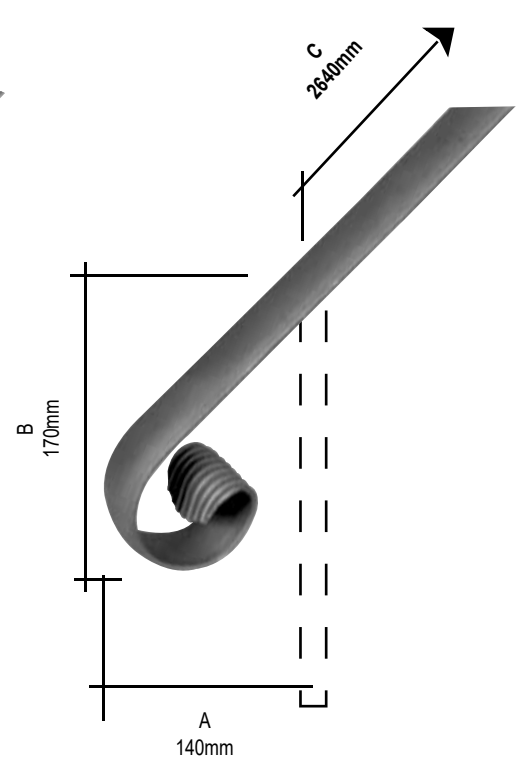

Art.12.P1.072 40 x 8 mm
Art.12.P1.073 40 x 10 mm
Art.12.P1.074 40 x 12 mm
Art.12.P1.075 50 x 10 mm

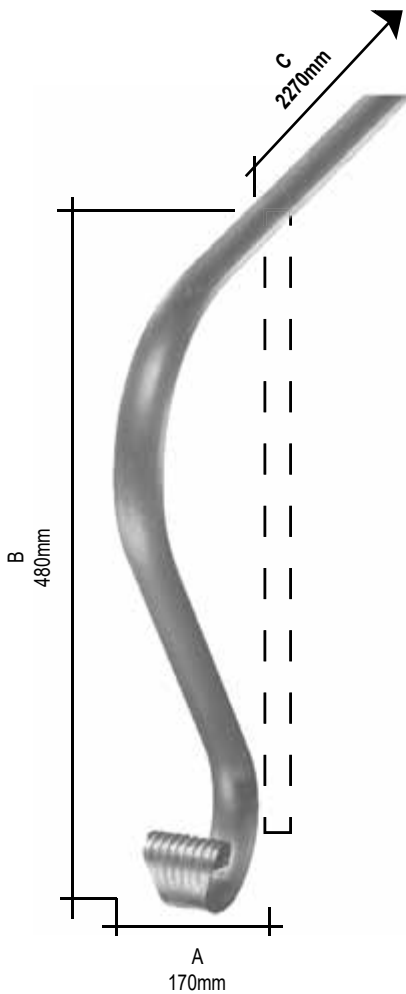

Art.12.P1.078.01 40 x 10 mm
Art.12.P1.079 40 x 12 mm

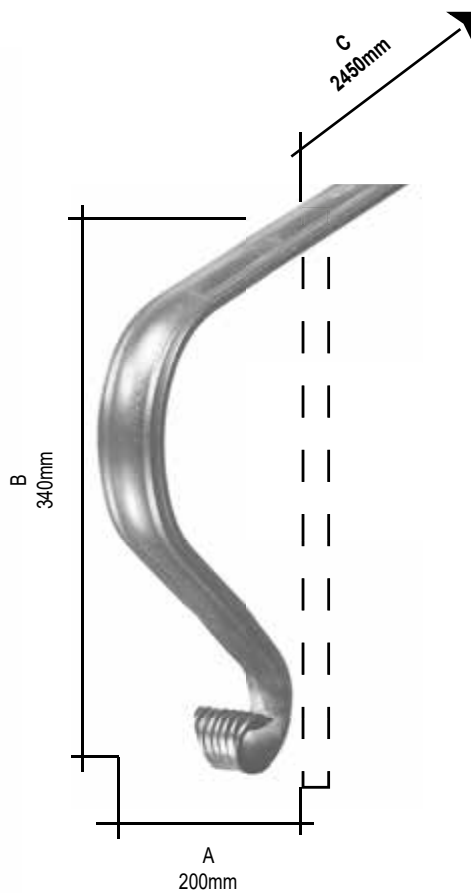

Art.12.P1.086 50 x 14 mm
Art.12.P1.086.01 40 x 12 mm
Art.12.P1.086.02 45 x 12 mm

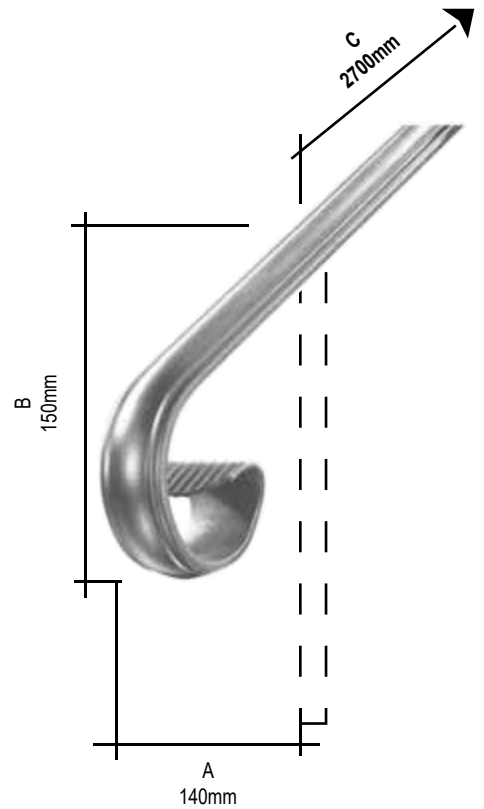

Art.12.P1.086.12 50 x 14 mm
Art.12.P1.086.13 40 x 12 mm
Art.12.P1.086.14 45 x 12 mm
Art.12.P1.086.15 60 x 16 mm

Tutte le parti di questo catalogo - foto comprese - sono di proprietà Euro-Fer. La riproduzione, anche parziale, è vietata in ogni forma e con ogni mezzo. / Every part of this catalogue - photos included - is Euro-Fer's property. All forms of copying are strictly prohibited.

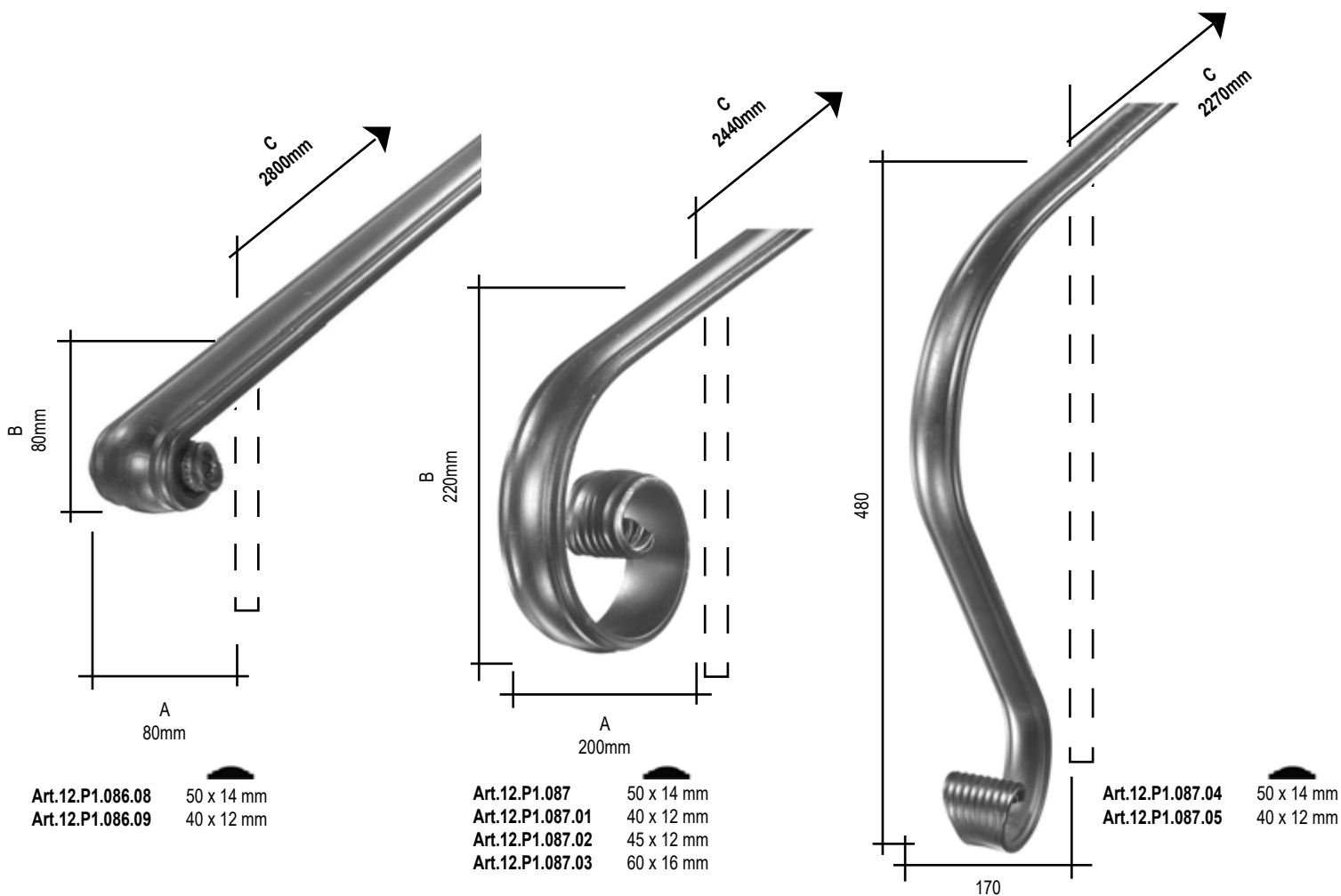

			C
<input type="checkbox"/>	Art.12.P1.013	40 x 8 mm	2680 mm
<input type="checkbox"/>	Art.12.P1.015	40 x 8 mm	2500 mm
<input type="checkbox"/>	Art.12.P1.017	40 x 8 mm	2640 mm
<input type="checkbox"/>	Art.12.P1.018	50 x 10 mm	2640 mm
<input type="checkbox"/>	Art.12.P1.056	40 x 8 mm	2670 mm
<input type="checkbox"/>	Art.12.P1.056.01	40 x 8 mm	2400 mm
<input type="checkbox"/>	Art.12.P1.072	40 x 8 mm	2640 mm
<input type="checkbox"/>	Art.12.P1.073	40 x 10 mm	2640 mm
<input type="checkbox"/>	Art.12.P1.074	40 x 12 mm	2640 mm
<input type="checkbox"/>	Art.12.P1.075	50 x 10 mm	2640 mm
<input type="checkbox"/>	Art.12.P1.078.01	40 x 10 mm	2270 mm
<input type="checkbox"/>	Art.12.P1.079	40 x 12 mm	2270 mm
<input type="checkbox"/>	Art.12.P1.086	50 x 14 mm	2450 mm
<input type="checkbox"/>	Art.12.P1.086.01	40 x 12 mm	2450 mm
<input type="checkbox"/>	Art.12.P1.086.02	45 x 12 mm	2450 mm
<input type="checkbox"/>	Art.12.P1.086.08	50 x 14 mm	2800 mm
<input type="checkbox"/>	Art.12.P1.086.09	40 x 12 mm	2800 mm
<input type="checkbox"/>	Art.12.P1.086.12	50 x 14 mm	2700 mm
<input type="checkbox"/>	Art.12.P1.086.13	40 x 12 mm	2700 mm
<input type="checkbox"/>	Art.12.P1.086.14	45 x 12 mm	2700 mm
<input type="checkbox"/>	Art.12.P1.086.15	60 x 16 mm	2700 mm
<input type="checkbox"/>	Art.12.P1.087	50 x 14 mm	2440 mm
<input type="checkbox"/>	Art.12.P1.087.01	40 x 12 mm	2440 mm
<input type="checkbox"/>	Art.12.P1.087.02	45 x 12 mm	2440 mm
<input type="checkbox"/>	Art.12.P1.087.03	60 x 16 mm	2440 mm
<input type="checkbox"/>	Art.12.P1.087.04	50 x 14 mm	2270 mm
<input type="checkbox"/>	Art.12.P1.087.05	40 x 12 mm	2270 mm

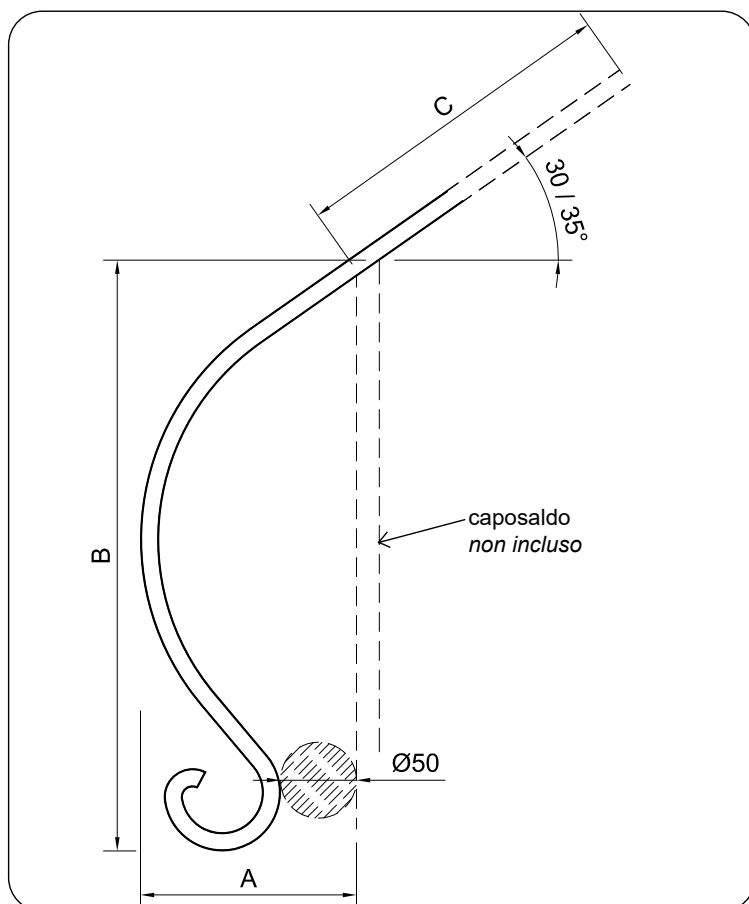





**TONDO
MARTELLATO
HAMMERED
ROUND**



**RIGATO +
MARTELLATO
HAMMERED
FLUTED**



**QUADRO
BATTUTO
4 LATI
SQUARE BARS
HAMMERED
ON 4 SIDES**



**MODELLO
CORTECCIA
BARK MODEL**

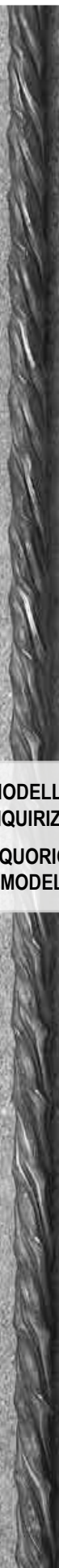

**MODELLO
LIQUIRIZIA
LIQUORICE
MODEL**



**RIGATO
4 FACCE
FLUTED
4 FACES**



H.200 mm.
Art. 13.001 12
Art. 13.002 14
Art. 13.003 16



Fiamma Grande / Big Flame
Liscio / Smooth
H.250X L.48 mm
Art. 13.001.02 12
H.250X L.51 mm
Art. 13.001.03 14
H.250X L.54 mm
Art. 13.001.04 16



Martellato / Hammered
H.200 mm.
Art. 13.003.01 12
Art. 13.003.02 14
Art. 13.003.03 16



Tondo / Round
H.200 mm.
Art. 13.003.04 12
Art. 13.003.05 14
Art. 13.003.06 16



Fiamma Grande / Big Flame
Tondo / Round
H.250X L.48 mm
Art. 13.003.07 12
H.250X L.51 mm
Art. 13.003.08 14
H.250X L.54 mm
Art. 13.003.09 16



Fiamma Grande / Big Flame
Martellato / Hammered
H.250X L.48 mm
Art. 13.003.10 12
H.250X L.51 mm
Art. 13.003.11 14
H.250X L.54 mm
Art. 13.003.12 16



H.200 mm.
Art. 13.004 12
Art. 13.005 14
Art. 13.006 16



Martellato / Hammered
H.200 mm.
Art. 13.006.01 12
Art. 13.006.02 14
Art. 13.006.03 16



Tondo / Round
H.200 mm.
Art. 13.006.04 12
Art. 13.006.05 14
Art. 13.006.06 16



H.250 mm.
Art. 13.007 12
Art. 13.008 14
Art. 13.009 16



Martellato / Hammered
H.250 mm.
Art. 13.009.01 12
Art. 13.009.02 14
Art. 13.009.03 16



Tondo / Round
H.250 mm.
Art. 13.009.04 14
Art. 13.009.05 16



H.200 mm.
Art. 13.010 12
Art. 13.011 14
Art. 13.012 16



Martellato / Hammered
H.200 mm.
Art. 13.012.01 12
Art. 13.012.02 14
Art. 13.012.03 16



Tondo / Round
H.200 mm.
Art. 13.012.04 12
Art. 13.012.05 14
Art. 13.012.06 16



Fiamma grande + pallina / Big flame + ball
Liscio / Smooth
H.250X L.48 mm
Art. 13.012.20 12
H.250X L.51 mm
Art. 13.012.21 14
H.250X L.54 mm
Art. 13.012.22 16
H.250X L.48 mm
Art. 13.012.23 12
H.250X L.51 mm
Art. 13.012.24 14
H.250X L.54 mm
Art. 13.012.25 16



H.200 mm.
Art. 13.013 12
Art. 13.014 14
Art. 13.015 16



Martellato / Hammered
H.200 mm.
Art. 13.015.01 12
Art. 13.015.02 14
Art. 13.015.03 16



Tondo / Round
H.200 mm.
Art. 13.015.04 12
Art. 13.015.05 14
Art. 13.015.06 16



H.150 mm.
Art. 13.016 12
Art. 13.017 14
Art. 13.018 16



Fiamma grande + pallina / Big flame + ball
Tondo / Round
H.250 mm.
Art. 13.015.20 12



Martellato / Hammered
H.150 mm.
Art. 13.018.01 12
Art. 13.018.02 14
Art. 13.018.03 16

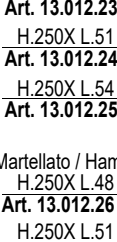

Martellato / Hammered
H.250X L.48 mm
Art. 13.012.26 12
H.250X L.51 mm
Art. 13.012.27 14
H.250X L.54 mm
Art. 13.012.28 16



Tondo / Round
H.150 mm.
Art. 13.018.04 12
Art. 13.018.05 14
Art. 13.018.06 16



H.200 mm.
Art. 13.018.07 12
Art. 13.018.08 14
Art. 13.018.09 16



Martellato / Hammered
H.200 mm.
Art. 13.018.10 12
Art. 13.018.11 14
Art. 13.018.12 16



H.200 mm.
Art. 13.018.13 12
Art. 13.018.14 14
Art. 13.018.15 16



Martellato / Hammered
H.200 mm.
Art. 13.018.16 12
Art. 13.018.17 14
Art. 13.018.18 16



Modello Catania / Catania model

H.200 mm.
Art. 13.018.19 □ 12
Art. 13.018.20 □ 14
Art. 13.018.21 □ 16

Martellato / Hammered
H.200 mm.
Art. 13.018.22 □ 12
Art. 13.018.23 □ 14
Art. 13.018.24 □ 16

H.200 mm.
Art. 13.019 □ 12
Art. 13.020 □ 14
Art. 13.021 □ 16

H.200 mm.
Art. 13.022 □ 12
Art. 13.023 □ 14
Art. 13.024 □ 16

Liscio / Smooth
H.200 mm
Art. 13.024.50 □ 12
Art. 13.024.51 □ 14
Art. 13.024.52 □ 16
Art. 13.024.53 □ 18
Art. 13.024.54 □ 20

Liscio / Smooth
H.200 mm
Art. 13.024.55 Ø 12
Art. 13.024.56 Ø 14
Art. 13.024.57 Ø 16
Art. 13.024.58 Ø 18
Art. 13.024.59 Ø 20

Liscio / Smooth
H.200 mm
Art. 13.024.100 □ 12
Art. 13.024.101 □ 14

Liscio / Smooth
H.200 mm
Art. 13.024.110 □ 12
Art. 13.024.111 □ 14

Liscio / Smooth H.200 mm Liscio / Smooth H.200 mm

Sfera / Sphere Ø20 Art. 13.024.145 Ø 12	Sfera / Sphere Ø35 Art. 13.024.159 Ø 12 Art. 13.024.160 Ø 16
Sfera / Sphere Ø25 Art. 13.024.150 Ø 12 Art. 13.024.151 Ø 14 Art. 13.024.153 □ 12	Sfera Forgiata Ø 25 / Forged Sphere Ø 25 Art. 13.024.161 □ 12 Art. 13.024.162 □ 14 Art. 13.024.170 Ø 12
Sfera / Sphere Ø30 Art. 13.024.156 Ø 12 Art. 13.024.157 Ø 14	

Vedi pagina 92 per le dimensioni delle palline
See page 92 for ball sizes



PALLINE GRANDI / LARGE BALLS

H.200 mm. Art. 13.025 □ 12 Art. 13.026 □ 14 Art. 13.027 □ 16 Art. 13.027.01 □ 18	Martellato / Hammered H.200 mm. Art. 13.027.02 □ 12 Art. 13.027.03 □ 14 Art. 13.027.04 □ 16 Art. 13.027.05 □ 18	Tondo / Round H.200 mm. Art. 13.027.06 Ø 12 Art. 13.027.07 Ø 14 Art. 13.027.08 Ø 16 Art. 13.027.09 Ø 18 Art. 13.027.10 Ø 20
--	--	---

Liscio / Smooth H.250 mm Liscio / Smooth H.250 mm

Art. 13.027.40 Ø 12 Art. 13.027.43 □ 12
Art. 13.027.41 Ø 14 Art. 13.027.44 □ 14
Art. 13.027.45 □ 16

Liscio / Smooth H.200 mm Liscio / Smooth H.200 mm

Art. 13.027.50 □ 12 Art. 13.027.55 □ 12
Art. 13.027.51 □ 14 Art. 13.027.56 □ 14
Art. 13.027.52 □ 16 Art. 13.027.57 □ 16

Punta a piramide / Pyramid Point Punta a matita → / Pencil Point

H.200 mm. Art. 13.028 □ 12 Art. 13.029 □ 14 Art. 13.030 □ 16 Art. 13.030.01 □ 18 Art. 13.030.02 □ 20	Martellato / Hammered H.200 mm. Art. 13.030.03 □ 12 Art. 13.030.04 □ 14 Art. 13.030.05 □ 16 Art. 13.030.06 □ 18 Art. 13.030.07 □ 20	Tondo / Round H.200 mm. Art. 13.030.08 Ø 12 Art. 13.030.09 Ø 14 Art. 13.030.10 Ø 16 Art. 13.030.11 Ø 18 Art. 13.030.12 Ø 20
---	---	---

H.230 mm. Martellato / Hammered H.230 mm. Tondo / Round H.230 mm.

Art. 13.030.13 □ 12 Art. 13.030.16 □ 12 Art. 13.030.19 Ø 12
Art. 13.030.14 □ 14 Art. 13.030.17 □ 14 Art. 13.030.20 Ø 14
Art. 13.030.15 □ 16 Art. 13.030.18 □ 16 Art. 13.030.21 Ø 16

H.230 mm. H.300 mm.

Art. 13.031 □ 14 Art. 13.031.51 □ 14
Art. 13.031.54 Ø 14

NEW

Pallina Grande / Large Ball
H.200 mm.
Art. 13.031.71 Ø 14 **NEW**
Art. 13.031.72 Ø 16







H.230 mm.
Art. 13.032 □ 14





Lancia forgiata a caldo / Hot forged spear









L.75 mm. L.75 mm.

Art. 13.032.04 □ 16 H.290 Art. 13.032.09 □ 12 H.270
Art. 13.032.06 □ 12 H.270 Art. 13.032.10 □ 14 H.280
Art. 13.032.07 □ 14 H.280 Art. 13.032.11 □ 16 H.290
Art. 13.032.08 □ 18 H.310 Art. 13.032.12 □ 18 H.310



Tutte le parti di questo catalogo - foto comprese - sono di proprietà Euro-Fer. La riproduzione, anche parziale, è vietata in ogni forma e con ogni mezzo. / Every part of this catalogue - photos included - is Euro-Fer's property. All forms of copying are strictly prohibited.

							
			NEW	NEW			
H.230 mm.	Martellato / <i>Hammered</i> H.230 mm.	Tondo / <i>Round</i> H.230 mm.	H.270 mm.	H.300 mm.	H.230 mm.	Martellato / <i>Hammered</i> H.230 mm.	Tondo / <i>Round</i> H.230 mm.
Art. 13.033 □ 14	Art. 13.033.03 □ 12	Art. 13.033.06 □ 12	Art. 13.033.10 □ 12	Art. 13.033.50 □ 12	Art. 13.034 □ 14	Art. 13.034.03 □ 12	Art. 13.034.06 □ 12
Art. 13.033.01 □ 16	Art. 13.033.04 □ 14	Art. 13.033.07 □ 14			Art. 13.034.01 □ 16	Art. 13.034.04 □ 14	Art. 13.034.07 □ 14
Art. 13.033.02 □ 12	Art. 13.033.05 □ 16	Art. 13.033.08 □ 16			Art. 13.034.02 □ 12	Art. 13.034.05 □ 16	Art. 13.034.08 □ 16

							
H.230 mm.	H.180 mm.	Martellato / <i>Hammered</i> H.180 mm.	Tondo / <i>Round</i> H.180 mm.	H.230 mm.	Martellato / <i>Hammered</i> H.230 mm.	Tondo / <i>Round</i> H.230 mm.	H.230 mm.
Art. 13.034.50 □ 12	Art. 13.035.01 □ 12	Art. 13.035.04 □ 12	Art. 13.035.07 □ 12	Art. 13.035.10 □ 12	Art. 13.035.14 □ 12	Art. 13.035.18 □ 12	Art. 13.035.22 □ 12
Art. 13.035 □ 14	Art. 13.035.02 □ 14	Art. 13.035.05 □ 14	Art. 13.035.08 □ 14	Art. 13.035.11 □ 14	Art. 13.035.15 □ 14	Art. 13.035.19 □ 14	Art. 13.035.23 □ 14
	Art. 13.035.03 □ 16	Art. 13.035.06 □ 16	Art. 13.035.09 □ 16	Art. 13.035.12 □ 16	Art. 13.035.16 □ 16	Art. 13.035.20 □ 16	Art. 13.035.24 □ 16
				Art. 13.035.13 □ 18	Art. 13.035.17 □ 18	Art. 13.035.21 □ 18	Art. 13.035.25 □ 18

							
H.250 mm.	Martellato / <i>Hammered</i> H.250 mm.	Tondo / <i>Round</i> H.250 mm.	Fascetta inserita a caldo <i>Hot-inserted clip</i> H.250 mm.	Fascetta inserita a caldo <i>Hot-inserted clip</i> Martellato / <i>Hammered</i> H.250 mm.	Fascetta inserita a caldo <i>Hot-inserted clip</i> Tondo / <i>Round</i> H.250 mm.	H.280 mm.	Martellato / <i>Hammered</i> H.280 mm.
Art. 13.035.26 □ 14	Art. 13.035.28 □ 14	Art. 13.035.30 □ 14	Art. 13.035.32 □ 14	Art. 13.035.34 □ 14	Art. 13.035.36 □ 14	Art. 13.035.38 □ 14	Art. 13.035.41 □ 14
Art. 13.035.27 □ 16	Art. 13.035.29 □ 16	Art. 13.035.31 □ 16	Art. 13.035.33 □ 16	Art. 13.035.35 □ 16	Art. 13.035.37 □ 16	Art. 13.035.39 □ 16	Art. 13.035.42 □ 16
					Art. 13.035.40 □ 18	Art. 13.035.43 □ 18	Art. 13.035.44 □ 18

Vedi pagina 92 per le dimensioni delle palline
See page 92 for ball sizes

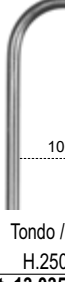
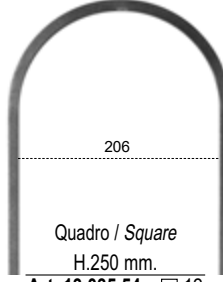
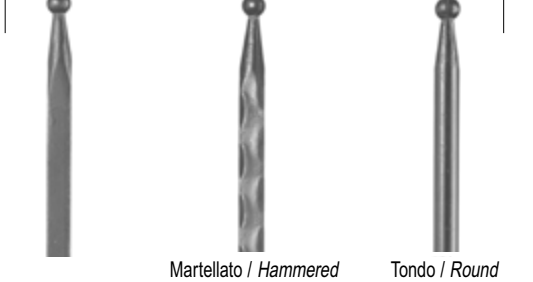
						
Tondo / <i>Round</i> H.280 mm.	Tondo Lavorato <i>Worked Round Bar</i> H.280 mm.	Tondo / <i>Round</i> H.250 mm.	Quadro / <i>Square</i> H.250 mm.	H.200 mm.	Martellato / <i>Hammered</i> H.200 mm.	Tondo / <i>Round</i> H.200 mm.
Art. 13.035.44 □ 14	Art. 13.035.47 □ 14	Art. 13.035.50 □ 12	Art. 13.035.54 □ 12	Art. 13.035.58 □ 12	Art. 13.035.63 □ 12	Art. 13.035.68 □ 12
Art. 13.035.45 □ 16	Art. 13.035.48 □ 16	Art. 13.035.51 □ 14	Art. 13.035.55 □ 14	Art. 13.035.59 □ 14	Art. 13.035.64 □ 14	Art. 13.035.69 □ 14
Art. 13.035.46 □ 18	Art. 13.035.49 □ 18	Quadro / <i>Square</i> H.250 mm.	Tondo / <i>Round</i> H.250 mm.	Art. 13.035.60 □ 16	Art. 13.035.65 □ 16	Art. 13.035.70 □ 16
		Art. 13.035.52 □ 12	Art. 13.035.56 □ 12	Art. 13.035.61 □ 18	Art. 13.035.66 □ 18	Art. 13.035.71 □ 18
		Art. 13.035.53 □ 14	Art. 13.035.57 □ 14	Art. 13.035.62 □ 20	Art. 13.035.67 □ 20	

Tutte le parti di questo catalogo - foto comprese - sono di proprietà Euro-Fer. La riproduzione, anche parziale, è vietata in ogni forma e con ogni mezzo. / Every part of this catalogue - photos included - is Euro-Fer's property. All forms of copying are strictly prohibited.



Pallina piccola / *Small ball*
Liscio / *Smooth*
H.200 mm
Art. 13.035.80 □ 12
Art. 13.035.81 □ 14
Art. 13.035.82 □ 16



Pallina piccola / *Small ball*
Martellato / *Hammered*
H.200 mm
Art. 13.035.85 □ 12
Art. 13.035.86 □ 14
Art. 13.035.87 □ 16

Modello mezza luna / *Half moon model*



Liscio / *Smooth*
H. 190 X L.120 mm
Art. 13.035.100
2 x ≠ 16 X 8 mm
Art. 13.035.101
2 x ≠ 12 X 6 mm



NEW

Liscio / *Smooth*
H. 210 X L.130 mm
Art. 13.035.110
2 x ≠ 16 X 8 mm
Art. 13.035.111
2 x ≠ 12 X 6 mm



Schiacciata sullo spigolo / *Ornament on the edge*
H.200 mm
Art. 13.035.140 □ 12
Art. 13.035.141 □ 14
Art. 13.035.142 □ 16
Liscio / *Smooth*



Martellato / *Hammered*
H.200 mm
Art. 13.035.150 □ 12
Art. 13.035.151 □ 14
Art. 13.035.152 □ 16



Liscio / *Smooth*
H.200 mm
Art. 13.035.153 □ 12
Art. 13.035.154 □ 14
Art. 13.035.155 □ 16



Liscio / *Smooth*
H.200 mm
Art. 13.035.300
≠ 25 x 8 mm
Art. 13.035.301
≠ 30 x 8 mm



H.150 X L.40 mm.
Art. 13.036 □ 12



H.180 X L.45 mm.
Art. 13.037 □ 14



H.190 X L.50 mm.
Art. 13.038 □ 16



H.200 X L.55 mm.
Art. 13.039 □ 18



H.210 X L.62 mm.
Art. 13.040 □ 20



H.125 X L.60 mm.
Art. 13.041 Ø 13



H.155 X L.70 mm.
Art. 13.042 Ø 16



H.190 X L.90 mm.
Art. 13.043 Ø 16



H.130 X L.50 mm.
Art. 13.044 Ø 15



H.130 X L.53 mm.
Art. 13.045 Ø 13



H.160 X L.65 mm.
Art. 13.046 Ø 17



H.195 X L.75 mm.
Art. 13.047 Ø 17



H. 110 X L. 55 mm
Art.13.048 Ø 20 mm

Fornite con inserto di plastica separato / *Provided with separate plastic thread*

Esempio di utilizzo
Example of use

 H.125 X L.58 mm. Art. 13.051.01 Fuori Produzione Out of Production base Ø 12,5 mm.	 H.155 X L.70 mm. Art. 13.051.03 Fuori Produzione Out of Production base Ø 16,5 mm.	 H.125 X L.60 mm. Art. 13.051.05 Fuori Produzione Out of Production base Ø 12,5 mm.	 H.155 X L.70 mm. Art. 13.051.07 base Ø 30 mm. foro Ø 16,5 mm.
 H.125 X L.58 mm. Art. 13.051.02 Fuori Produzione Out of Production base Ø 12,5 mm.	 H.155 X L.70 mm. Art. 13.051.04 Fuori Produzione Out of Production base Ø 16,5 mm.	Art. 13.051.06 base Ø 26 mm. foro □ 12,5 mm.	Art. 13.051.08 base Ø 30 mm. foro □ 14,5 mm.

Tutte le parti di questo catalogo - foto comprese - sono di proprietà Euro-Fer. La riproduzione, anche parziale, è vietata in ogni forma e con ogni mezzo. / Every part of this catalogue - photos included - is Euro-Fer's property. All forms of copying are strictly prohibited.

H.130 X L.60 mm.
Art. 13.052 Ø12H.130 X L.60 mm.
Art. 13.052.01 Ø12H.130 X L.60 mm.
Art. 13.052.02
base Ø 12 mm.H.155 X L.70 mm.
Art. 13.053 Ø 17H.190 X L.95 mm.
Art. 13.054 Ø 20H.80 X L.45 mm.
Art. 13.055 Ø 20H.78 X L.45 mm.
Art. 13.055.F12 Ø 12H.125 X L.65 mm.
Art. 13.056 Ø 25H.140 X L.80 mm.
Art. 13.057 Ø 38H.120 X L.55 mm.
Art. 13.058 Ø 20H.135 X L.65 mm.
Art. 13.059 Ø 25H.125 X L.63 mm.
Art. 13.059.01 Ø 24
H.138 X L.67 mm.
Art. 13.059.02 Ø 25
H.163 X L.83 mm.
Art. 13.059.03 Ø 30H.115 X L.58 mm.
Art. 13.060 Ø 20H.115 X L.58 mm.
Art. 13.060.02
base Ø 21,5 mm.
H.140 X L.70 mm.
Art. 13.061.02
base Ø 26 mm.H.113 X L.57 mm.
Art. 13.060.F12 Ø 12H.140 X L.70 mm.
Art. 13.061 Ø 26H.70 X L.60 mm.
Art. 13.062 □ 12H.130 X L.60 mm.
Art. 13.063.01 □ 14H.140 X L.60 mm.
Art. 13.064 ≧ 14X 8H.125 mm.
Art. 13.064.01
base Ø 15 mm.
H.100 mm.
Art. 13.064.02
base Ø 12 mm.H.125 mm.
Art. 13.064.03
base Ø 15 mm.
H.100 mm.
Art. 13.064.04
base Ø 12 mm.H.120 X L.42 mm.
Art. 13.065 □ 12
H.140 X L.46 mm.
Art. 13.066 □ 14H.150 mm.
Art. 13.067 □ 14H.125 mm. - base Ø 15 mm.
Art. 13.067.01 Rosso / Red
Art. 13.067.02 Azzurro Int. / Intense Azure
Art. 13.067.03 Verde Smeraldo / Green
Art. 13.067.04 Giallo Vivace / Vivid Yellow
Art. 13.067.06 Blu Oltremare / Dark BlueH.100 mm. - base Ø 12 mm.
Art. 13.067.07 Rosso / Red
Art. 13.067.09 Verde Smeraldo / GreenH.170 X L.52 mm.
Art. 13.068 □ 14H.150 X L.45 mm.
Art. 13.070 □ 14
base Ø 28H.150 X L.40 mm.
Art. 13.070.01
base □ 16H.125 X L.40 mm.
Art. 13.071 Ø 25H.135 X L.40 mm.
Art. 13.072 Ø 25H.160 X L.50 mm.
Art. 13.073 Ø 30H.190 X L.55 mm.
Art. 13.074 Ø 32H.175 X L.60 mm.
Art. 13.075 Ø 35H.195 X L.55 mm.
Art. 13.076 Ø 38

Decorazioni con vetro colorato / Coloured glass decorations



H.125 X L.60 mm.
Art. 13.077 Ø 32



H.110 mm.
Art. 13.077.01
base Ø 25 mm.



H.110 mm.
Art. 13.077.02
base Ø 25 mm.



H.110 X L.60 mm.
Art. 13.077.04



H.125 X L.65 mm.
Art. 13.077.05



H.140 X L.70 mm.
Art. 13.077.06



H.140 X L.60 mm.
Art. 13.078 □ 15



H.130 X L.70 mm.
Art. 13.079 □ 20

H.125 mm.
Art. 13.077.03
base Ø 32 mm.



H.155 X L.65 mm.
Art. 13.080 Ø 16



H.190 mm.
Art. 13.080.01
base Ø 35 mm.



H.200 mm.
Art. 13.080.03
base Ø 32 mm.



H.150 mm.
Art. 13.080.07
base Ø 16 mm.



H.125 X L.45 mm.
Art. 13.083 Ø 25



H.140 X L.57 mm.
Art. 13.084 Ø 33



H.190 X L.68 mm.
Art. 13.085 Ø 40

H.142 mm.
Art. 13.080.02
base Ø 28 mm.

H.160 mm.
Art. 13.080.04
base Ø 26 mm.

H.110 mm.
Art. 13.080.06
base Ø 18 mm.

H.125 x L.50 mm
Art. 13.080.08 Ø 25 mm



H.133 mm.
Art. 13.085.01
base □ 20



H.260 X L.24 mm.
Art. 13.086 Ø 17



H.260 mm.
Art. 13.086.01
base Ø 50 mm.



H.150 mm.
Art. 13.086.03
base Ø 30 mm.



H.110 X L.36 mm.
Art. 13.086.04
base Ø 25 mm.



H.200 mm.
Art. 13.086.05 Ø 12
Art. 13.086.06 Ø 14
Art. 13.086.09 Ø 25



H.110 X L.27 mm.
Art. 13.087 Ø 27



H.130 x L.32 mm.
Art. 13.087.01 □ 30

H.180 mm.
Art. 13.086.02
base Ø 35 mm.



H.150 mm.
Art. 13.090.01
base □ 40 mm.

H.125 mm.
Art. 13.090.03
base □ 25 mm.



H.125 X L.30 mm.
Art. 13.091
base □ 20 mm.
quadrello □ 10 mm.



H.125 X L.32 mm.
Art. 13.088 Ø 32



H.160 mm. L.25 mm
Art. 13.089 □ 25 mm.



H.110 mm. L.18 mm
Art. 13.089.01
□ 18 mm.



H.150 X L.40 mm.
Art. 13.090 □ 40

H.135 mm.
Art. 13.090.02
base □ 32 mm.

H.100 mm.
Art. 13.090.04
base □ 20 mm.

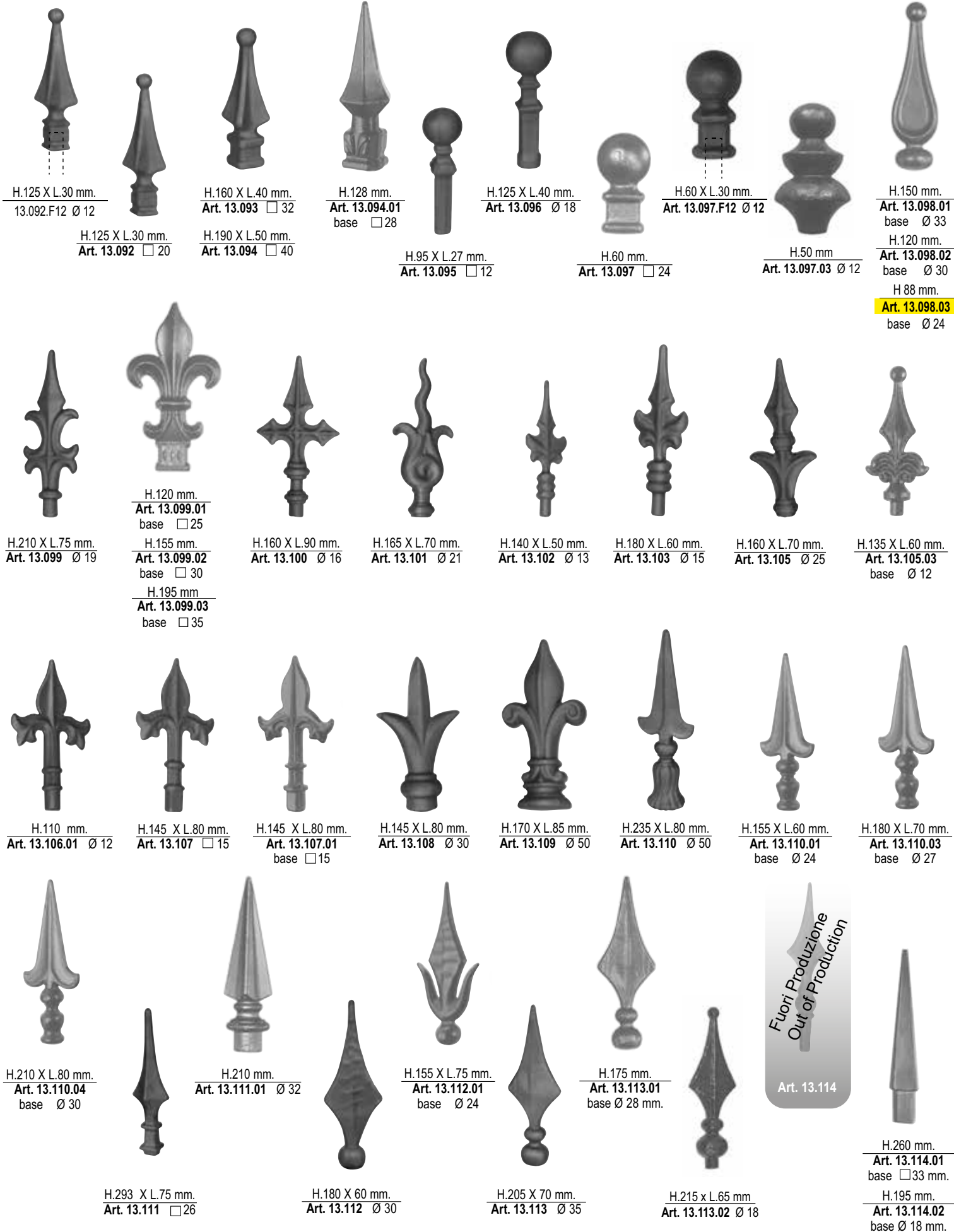



H.135 X L.48 mm.
Art. 13.115 Ø 29



H.165 X L.53 mm.
Art. 13.116 Ø 29



H.180 X L.55 mm.
Art. 13.117 Ø 29



H.170 X L.58 mm.
Art. 13.117.01 Ø 30

H.138 X L.53 mm.
Art. 13.115.01 Ø 28

H.160 X L.56 mm.
Art. 13.116.01 Ø 28



H.205 X L.62 mm.
Art. 13.118 Ø 35



H.243 X L.72 mm.
Art. 13.119 Ø 40



H.95 X L.40 mm.
Art. 13.120
base ≙ 12 X 4



H.140 X L.55 mm.
Art. 13.121
base ≙ 15 X 4



H.170 X L.60 mm.
Art. 13.122
base ≙ 20 X 8



H.180 X L.55 mm.
Art. 13.123 Ø 37



H.200 X L.55 mm.
Art. 13.124 Ø 35



H.130 X L.47 mm.
Art. 13.126 Ø 33



H.130 X L.33 mm.
Art. 13.127 Ø 30



H.135 X L.30 mm.
Art. 13.128 □ 30



H.145 mm.
Art. 13.129 □ 25
Art. 13.130 □ 30



H.155 mm.
Liscio / Smooth
Art. 13.131 □ 35
Art. 13.132 □ 40



H.155 mm.
Liscio / Smooth
Art. 13.131.01 □ 50

NEW



H.66 mm.
Liscio / Smooth
Art. 13.131.02 □ 29



H.115 X L.30 mm.
Art. 13.132.01 □ 8



H.220 X L.30 mm.
Art. 13.132.02 □ 12



H.39 X L.40 mm.
Art. 13.133



H.67 X L.40 mm.
Art. 13.134



H.39 X L.40 mm.
Art. 13.135 Ø 12,5
Art. 13.136 Ø 14,5
Art. 13.137 Ø 16,5

H.36 x L.37 mm
Art. 13.135.E Ø 12,5
Art. 13.136.E Ø 14,5
Art. 13.137.E Ø 16,5

Rullate / Rolled
H.39 x L.40 mm
Art. 13.135.R Ø 12,5
Art. 13.136.R Ø 14,5
Art. 13.137.R Ø 16,5



Borchie Svasate /
Countersunk Ironstud
H.39 x L.40 mm
Art. 13.135.B Ø 12,5
Art. 13.136.B Ø 14,5
Art. 13.137.B Ø 16,5



H.67 X L.40 mm.
Art. 13.138 Ø 12,5
Art. 13.139 Ø 14,5
Art. 13.140 Ø 16,5

H.63 x L.37 mm
Art. 13.138.E Ø 12,5
Art. 13.139.E Ø 14,5
Art. 13.140.E Ø 16,5

Rullate / Rolled
H.67 x L.40 mm
Art. 13.138.R Ø 12,5
Art. 13.139.R Ø 14,5
Art. 13.140.R Ø 16,5

H.63 x L.38 mm
Art. 13.140.RE Ø 16,5

NUOVE BORCHIE IN TUBO / NEW STUDS IN TUBE



H.39 x L. 40 mm
Art. TB.13.135 Ø 12,5
Art. TB.13.136 Ø 14,5
Art. TB.13.137 Ø 16,5



H.67 x L. 40 mm
Art. TB.13.138 Ø 12,5
Art. TB.13.139 Ø 14,5
Art. TB.13.140 Ø 16,5



H.39 x L. 40 mm
Art. TB.13.141 □ 12,5



H.67 x L. 40 mm
Art. TB.13.142 □ 12,5

H.44 x L. 45 mm
Art. TB.13.150 □ 14,5
Art. TB.13.150.01 □ 16,5

H.67 x L. 45 mm
Art. TB.13.152 □ 14,5
Art. TB.13.153 □ 16,5

**Attenzione: Sezione Cava! Eventualmente, avvisare lo zincatore.
Be Careful: Hole Section! Eventually, inform the galvanizer.**

Articoli in ferro fuso / Cast steel items
Senza inserto / Without insert



H.65 x L.40 mm
Art. CS.13.142 □ 12,5



H.67 x L.45 mm
Art. CS.13.151 □ 12,5
Art. CS.13.152 □ 14,5
Art. CS.13.153 □ 16,5



H.39 x L.40 mm
Art. 13.141 □ 12,5

Rullate / Rolled
H.39 x L.40 mm
Art. 13.141.R □ 12,5



H.67 X L.40 mm.
Art. 13.142 □ 12,5

Rullate / Rolled
H.67 X L.40 mm.
Art. 13.142.R □ 12,5

H. 63 X L. 38 mm.
Art. 13.142.RE □ 12,5



H.44 X L.45 mm.
Art. 13.143

Rullate / Rolled
H.44 X L.45 mm.
Art. 13.143.R



H.67 X L.45 mm.
Art. 13.144

Rullate / Rolled
H.67 X L.45 mm.
Art. 13.144.R



H.44 X L. 45 mm.
Art. 13.145 Ø 14,5
Art. 13.146 Ø 16,5
Art. 13.146.01 Ø 18,5
Art. 13.146.02 Ø 20,5

Rullate / Rolled
H.44 X L. 45 mm.
Art. 13.145.R Ø 14,5
Art. 13.146.R Ø 16,5
Art. 13.146.01.R Ø 18,5



H.67 X L. 45 mm.
Art. 13.147 Ø 14,5
Art. 13.148 Ø 16,5
Art. 13.148.01 Ø 18,5
Art. 13.148.02 Ø 20,5



H.44 X L.45 mm.
Art. 13.149 □ 12,5
Art. 13.150 □ 14,5
Art. 13.150.01 □ 16,5

Rullate / Rolled
H.44 X L.45 mm.
Art. 13.149.R □ 12,5
Art. 13.150.R □ 14,5
Art. 13.150.01.R □ 16,5



H.67 X L.45 mm.
Art. 13.151 □ 12,5
Art. 13.152 □ 14,5
Art. 13.153 □ 16,5

Rullate / Rolled
H.67 X L.45 mm.
Art. 13.151.R □ 12,5
Art. 13.152.R □ 14,5
Art. 13.153.R □ 16,5



H.47 X L.50 mm.
Art. 13.154



Art. 13.155



H.47 X L.50 mm.
Art. 13.156 Ø 16,5
Art. 13.157 Ø 18,5
Art. 13.158 Ø 20,5
Art. 13.158.01 Ø 22,5



H.80 X L.50 mm.
Art. 13.159 Ø 16,5
Art. 13.160 Ø 18,5
Art. 13.161 Ø 20,5
Art. 13.161.01 Ø 22,5



H.47 X L.50 mm.
Art. 13.162 □ 14,5
Art. 13.163 □ 16,5



H.80 X L.50 mm.
Art. 13.164 □ 14,5
Art. 13.165 □ 16,5

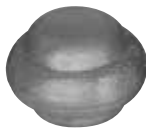

H.25 X L.35 mm.
Art. 13.166

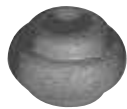

H.25 X L.35 mm.
Art. 13.167 Ø 12,5
Art. 13.167.01 Ø 14,5
Art. 13.167.02 Ø 16,5

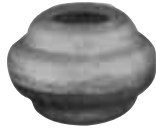

H.25 X L.35 mm.
Art. 13.167.03 □ 12,5
Art. 13.167.04 □ 14,5

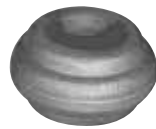

H.22 X L.40 mm.
Art. 13.168 Ø 14,5
Art. 13.168.01 Ø 16,5
Art. 13.168.02 Ø 12,5



H.35 X L.55 mm.
Art. 13.168.03 Ø 18,5
Art. 13.168.04 Ø 20,5
Art. 13.168.05 Ø 25,5
Art. 13.168.06 Ø 30,5



H.35 X L.55 mm.
Art. 13.168.07 □ 20,5
Art. 13.168.08 □ 25,5
non in produzione
not in production



H.22 X L.40 mm.
Art. 13.169 □ 14,5
Art. 13.169.01 □ 16,5
Art. 13.169.02 □ 12,5



H.22 X L.33 mm.
Art. 13.169.03 □ 12,5
H.22 X L.38 mm.
Art. 13.169.05 □ 14,5
Art. 13.169.06 □ 16,5



H.35 X L.55 mm.
Art. 13.169.07 □ 20,5
Art. 13.169.08 □ 22,5
Art. 13.169.09 □ 25,5



H.32 X L.47 mm.
Art. 13.169.10 □ 12,5
Art. 13.169.11 □ 14,5
Art. 13.169.12 □ 16,5
Art. 13.169.13 □ 18,5



H.60 X L.35 mm.
Art. 13.170.R



H.30 X L.35 mm.
Art. 13.170.01.R



H.60 X L.35 mm.
Art. 13.171.R Ø 14,5
Art. 13.172.R Ø 16,5
Art. 13.173.R Ø 18,5
Art. 13.173.01.R Ø 12,5
Art. 13.173.02.R □ 12



H.30 X L.35 mm.
Art. 13.173.03.R Ø 12,5
Art. 13.173.04.R Ø 14,5
Art. 13.173.05.R Ø 16,5
Art. 13.173.06.R Ø 18,5
Art. 13.173.07.R □ 12

BORCHIE TORNITE / TURNED BUSHES



H.24 X L.35 mm.
Art. 13.173.08 Ø 12,5
Art. 13.173.09 Ø 14,5
Art. 13.173.10 Ø 16,5



H.20 X L.40 mm.
Art. 13.173.11 Ø 12,5
Art. 13.173.12 Ø 14,5
Art. 13.173.13 Ø 16,5



H.25 X L.40 mm.
Art. 13.173.14 Ø 25,5



H.26 X L.35 mm.
Art. 13.173.15 Ø 12,5
Art. 13.173.16 Ø 14,5
Art. 13.173.17 Ø 16,5
Art. 13.173.18 Ø 18,5



H.60 X L.35 mm.
Art. 13.173.19 Ø 12,5
Art. 13.173.20 Ø 14,5
Art. 13.173.21 Ø 16,5
Art. 13.173.22 Ø 18,5



H.60 X L.35 mm.
Art. 13.173.23 Ø 14,5



H.25 X L.35 mm.
Art. 13.173.24 Ø 14,5



H.25 X L.35 mm.
Art. 13.173.25 Ø 14,5



H.24 X L.35 mm.
Art. 13.173.26 Ø 14,5



H.23 X L.35 mm.
Art. 13.173.27 Ø 14,5



H.7 X L.15 mm.
Art. 13.173.28
foro Ø 8



H.55 X L. 40 mm.
Art. 13.174 Ø 14,5
senza foro



H.55 X L.40 mm.
Art. 13.175 Ø 14,5
Art. 13.175.01 Ø 16,5
Art. 13.175.02 Ø 12,5
Art. 13.175.03 □ 12

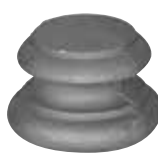

H.52 X L.69 mm.
Art. 13.176



H.80 X L.69 mm.
Art. 13.177



H.52 X L.69 mm.
Art. 13.178 Ø 27,5
Art. 13.179 Ø 30,5
Art. 13.180 Ø 35,5
Art. 13.181 Ø 40,5
Art. 13.181.01 □ 25,5
Art. 13.181.02 □ 30,5



H.80 X L.69 mm.
Art. 13.182 Ø 27,5
Art. 13.183 Ø 30,5
Art. 13.184 Ø 35,5
Art. 13.185 Ø 40,5
Art. 13.185.01 □ 25,5
Art. 13.185.02 □ 30,5



H.55 X L.35 mm.
Art. 13.185.03



H.55 X L.35 mm.
Art. 13.185.04 Ø 12,5
Art. 13.185.05 Ø 14,5
Art. 13.185.06 Ø 16,5
Art. 13.185.07 Ø 18,5



H.55 X L.35 mm.
Art. 13.185.08 □ 12,5
Art. 13.185.09 □ 14,5
non in produzione
not in production



Art. 13.185.10



H.75 X L.49 mm.
Art. 13.185.13 Ø 20,5
Art. 13.185.14 Ø 22,5



H.75 X L.49 mm.
Art. 13.185.15 □ 14,5
Art. 13.185.16 □ 16,5



H.70 X L.64 mm.
Art. 13.185.17 □ 16,5
Art. 13.185.17.01 □ 14,5
NEW



H.55 x L.60 mm
Art. 13.185.18 base 37 Senza foro / Without hole
Art. 13.185.19 Ø 20,5 Art. 13.185.22 Ø 27,5
Art. 13.185.20 Ø 22,5 Art. 13.185.23 □ 14,5
Art. 13.185.21 Ø 25,5 Art. 13.185.24 □ 16,5



H.110 x L.40 mm
Art. 13.185.25 Ø 16,5



H.70 x L.45 mm
Art. 13.185.26 Ø 20



H.135 mm
Art. 13.185.27 Ø 14,5
H.150 mm
Art. 13.185.28 Ø 16,5



H.70 mm
Art. 13.185.30 Ø 14,5
H.80 mm
Art. 13.185.31 Ø 16,5



H.55 X L.47 mm.
Art. 13.186



H.55 X L.47 mm.
Art. 13.187 Ø 14,5
Art. 13.188 Ø 16,5
Art. 13.188.01 Ø 18,5
Art. 13.188.02 Ø 12,5
Art. 13.189 □ 14,5
Art. 13.190 □ 16,5
Art. 13.190.01 □ 12,5



H.125 X L.35 mm.
Art. 13.190.02 S.F.
Art. 13.190.03 Ø 12,5
Art. 13.190.04 Ø 14,5
Art. 13.190.05 Ø 16,5
Art. 13.190.06 Ø 18,5
Art. 13.190.07 □ 14,5
Art. 13.190.08 □ 16,5



H.120 X L.28 mm.
Art. 13.191 S.F.
Art. 13.192 Ø 14,5
Art. 13.193 Ø 16,5
Art. 13.193.01 Ø 12,5
Art. 13.193.02 □ 12,5



H.70 X L.35 mm.

Art. 13.194 S.F.
Art. 13.195 Ø 16,5
Art. 13.195.01 Ø 18,5
Art. 13.195.02 Ø 14,5
Art. 13.195.03 Ø 12,5
Art. 13.195.04 □ 14,5
Art. 13.195.05 □ 16,5



H.64 X L.33 mm.

Art. 13.196 S.F.
Art. 13.197 Ø 14,5
Art. 13.198 Ø 16,5
Art. 13.198.01 Ø 12,5
Art. 13.198.02 □ 12,5



H.50 X L.45 mm.

Art. 13.199



H.90 X L.45 mm.

Art. 13.200



H.50 X L.45 mm.

Art. 13.201 □ 14,5
Art. 13.202 □ 16,5
Art. 13.202.01 □ 18,5
Art. 13.202.02 Ø 18,5
Art. 13.202.03 Ø 20,5
Art. 13.202.04 Ø 22,5
Art. 13.202.05 Ø 25,5



H.90 X L.45 mm.

Art. 13.203 Ø 14
Art. 13.204 Ø 18,5
Art. 13.204.01 Ø 20,5
Art. 13.204.02 Ø 22,5
Art. 13.204.03 Ø 25,5
Art. 13.205 □ 14,5
Art. 13.206 □ 16,5
Art. 13.206.01 □ 18,5



H.40 X L.40 mm.

Art. 13.207



H.68 X L.40 mm.

Art. 13.208



H.40 X L.40 mm.

Art. 13.209 □ 12,5
Art. 13.210 □ 14,5
Art. 13.210.01 □ 16,5
Art. 13.210.02 Ø 16,5
Art. 13.210.03 Ø 18,5
Art. 13.210.04 Ø 20,5
Art. 13.210.05 Ø 22,5



H.68 X L.40 mm.

Art. 13.211 □ 12,5
Art. 13.212 □ 14,5
Art. 13.213 □ 16,5
Art. 13.213.01 Ø 16,5
Art. 13.213.02 Ø 18,5
Art. 13.213.03 Ø 20,5
Art. 13.213.04 Ø 22,5



H.45 X L.40 mm.

Art. 13.213.05 □ 12,5
Art. 13.213.06 □ 14,5



H.25 X L.40 mm.

Art. 13.213.07 □ 12,5
Art. 13.213.08 □ 14,5



H.45 X L.40 mm.

Art. 13.213.10 Ø 14,5
Art. 13.213.11 Ø 16,5



H.25 X L.40 mm.

Art. 13.213.12 Ø 12,5
Art. 13.213.13 Ø 14,5
Art. 13.213.14 Ø 16,5

BORCHIE IN TUBO DI FERRO / TUBULAR IRON BUSHES



H.90 X L.40 mm

Art. TB.13.213.16 Ø 14,5



H.45 X L.30 mm

Art. TB.13.213.19 Ø 12,5
Art. TB.13.213.20 Ø 14,5



H.15 X L.30 mm

Art. TB.13.213.22 Ø 14,5



H.68 X L. 30 mm

Art. TB.13.213.17 Ø 12,5
Art. TB.13.213.18 Ø 14,5



H.20 x L. 30 mm

Art. TB.13.213.23 Ø 12,5



H.118 x L. 40 mm

Art. TB.13.213.25 Ø 14,5
Art. TB.13.213.26 Ø 16,5



H.140 x L. 30 mm

Art. TB.13.213.30 Ø 12,5
Art. TB.13.213.31 Ø 14,5



H.118 x L. 30 mm

Art. TB.13.213.34 Ø 12,5
Art. TB.13.213.35 Ø 14,5



H.83 x L. 30 mm

Art. TB.13.213.38 Ø 12,5
Art. TB.13.213.39 Ø 14,5



H.65 x L. 30 mm

Art. TB.13.213.44 Ø 12,5
Art. TB.13.213.45 Ø 14,5



H.90 X L. base 40 mm.
Art. 13.214



H.90 X L. base 40 mm.
Art. 13.214.01



H.120 X L. base 55 mm.
Art. 13.216

H.190 X L. base 90 mm.
Art. 13.216.01

H.150 X L. base 70 mm.
Art. 13.216.02

H.85 X L. base 43 mm.
Art. 13.216.03

H.55 X L. base 28 mm.
Art. 13.216.04



H.90 mm.
Art. 13.217
base Ø 50 mm.



H.180 mm.
Art. 13.218
base Ø 100 mm.



H. 57 X L. base 36 mm.
Art. 13.218.01
base □ 16 mm.



H.80 mm.
Art. 13.219
base 28 mm.



H.100 mm.
Art. 13.220
base 50 mm.



H.180 mm.
Art. 13.221
base 100 mm.



H.140 mm. - sfera Ø 110
Art. 13.221.01
base Ø 90 mm.

H.125 mm. - sfera Ø 90
Art. 13.221.02
base Ø 70 mm.



H.100 mm. - sfera Ø 70
Art. 13.221.03
base Ø 55 mm.

H.85 mm. - sfera Ø 55
Art. 13.221.04
base Ø 45 mm.



H.200 mm.
Art. 13.221.05
base Ø 50 mm.



H.100 mm.
Art. 13.222
base Ø 50 mm.

H.180 mm.
Art. 13.222.01
base Ø 100 mm.



Art. 13.223



H.90 X L.35 mm.
Art. 13.223.01 Ø 16,5
Art. 13.223.02 Ø 18,5
Art. 13.223.03 Ø 22,5



H.90 X L.35 mm.
Art. 13.223.04 □ 14,5
Art. 13.223.05 □ 16,5



H.135 X L.36 mm.
Art. 13.223.06 Senza foro/Without hole
Art. 13.223.07 Con foro/With hole Ø 12,5
Art. 13.223.08 Con foro/With hole Ø 14,5
Art. 13.223.09 Con foro/With hole Ø 16,5
Art. 13.223.10 Con foro/With hole □ 12,5



H.75 X L.36 mm.
Art. 13.223.11 Senza foro/Without hole
Art. 13.223.12 Con foro/With hole Ø 12,5
Art. 13.223.13 Con foro/With hole Ø 14,5
Art. 13.223.14 Con foro/With hole Ø 16,5
Art. 13.223.15 Con foro/With hole □ 12,5



H.48 X L.38 mm.
Art. 13.223.16 Senza foro/Without hole
Art. 13.223.17 Con foro/With hole Ø 12,5
Art. 13.223.18 Con foro/With hole Ø 14,5
Art. 13.223.19 Con foro/With hole Ø 16,5
Art. 13.223.20 Con foro/With hole □ 12,5



H.96 X L.38 mm.
Art. 13.223.21 Senza foro/Without hole
Art. 13.223.22 Con foro/With hole Ø 12,5
Art. 13.223.23 Con foro/With hole Ø 14,5
Art. 13.223.24 Con foro/With hole Ø 16,5
Art. 13.223.25 Con foro/With hole □ 12,5



H.40 X L.30 mm.
Art. 13.223.26 Ø 12,5
Art. 13.223.27 Ø 14,5
Art. 13.223.28 □ 12,5



H.90 mm.
Art. 13.224.01
base Ø 40 mm.
H.65 mm.
Art. 13.224.02
base Ø 27 mm.



H.70 X L.30 mm.
Art. 13.224.03
base □ 23 mm.



H.50 X L.35 mm.
Art. 13.226



H.130 mm.
Art. 13.227
Ø 75 mm.



H.120 mm.
Art. 13.228
Ø 75 mm.



H.155 X L.60 mm.
Art. 13.228.01
base Ø 35 mm.



H.120 mm.
Art. 13.229
Ø 75 mm.



H.90 X L.50 mm.
Art. 13.229.01
base Ø 33 mm.



H.100 mm.
Art. 13.230
Ø 55 mm.



H.155 X L.50 mm.
Art. 13.230.01
base Ø 22 mm.



H.130 mm.
Art. 13.231
Ø 60 mm.



H.90 mm.
Art. 13.232
Ø 50 mm.



H.100 mm.
Art. 13.233
Ø 55 mm.



H.75 X L.30 mm.
Art. 13.233.01



H.50 X L.30 mm.
Art. 13.234



H.65 X L.35 mm.
Art. 13.235



H.60 mm.
Art. 13.235.01
base □ 25 mm.

H.150 mm.
Art. 13.235.04
base □ 80 mm.

H.60 mm.
Art. 13.235.06
base Ø 27 mm.

H.150 mm.
Art. 13.235.09
base Ø 60 mm.



H.150 mm. / Ø100 mm.
Art.13.235.11
base □100 mm.
H.120 mm. / Ø 80 mm.
Art.13.235.12
base □80 mm.
H.105 mm. / Ø 70 mm.
Art.13.235.13
base □60 mm.

H.75 mm. / Ø 50 mm.
Art.13.235.14
base □40 mm.
H.45 mm. / Ø 30 mm.
Art.13.235.15
base □25 mm.

H.85 mm.
Art. 13.235.02
base □ 40 mm.

H.200 mm.
Art. 13.235.05
base □100 mm.

H.85 mm.
Art. 13.235.07
base Ø 42 mm.

H.200 mm.
Art. 13.235.10
base Ø 90 mm.

H.125 mm.
Art. 13.235.03
base □ 60 mm.

H.125 mm.
Art. 13.235.08
base Ø 48 mm.



H.45 mm.
Art. 13.236
Ø 30 mm.

H.70 mm.
Art. 13.238
Ø 55 mm.

H.65 mm.
Art. 13.237
Ø 50 mm.

H.80 mm.
Art. 13.239
Ø 65 mm.



H.65 mm
Art.13.237.S
base □50 mm.

NEW

Ideale per saldatura su
tubo 30 x 30 x 2 mm.
Ideal for welding
on 30 x 30 x 2 pipe.



Sfere Lisce / Smooth Spheres

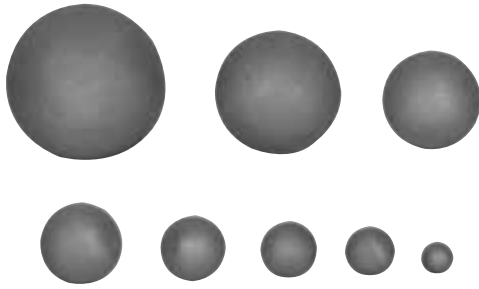

Art. 13.240	Ø 15 mm.
Art. 13.241	Ø 20 mm.
Art. 13.242	Ø 25 mm.
Art. 13.243	Ø 30 mm.
Art. 13.244	Ø 35 mm.
Art. 13.245	Ø 40 mm.
Art. 13.246	Ø 50 mm.
Art. 13.247	Ø 60 mm.
Art. 13.248	Ø 70 mm.
Art. 13.249	Ø 80 mm.
Art. 13.250	Ø 90 mm.
Art. 13.251	Ø 100 mm.
Art. 13.251.01	Ø 120 mm.

Sfere Vuote in lamiera / Hollow Spheres in Iron Sheet

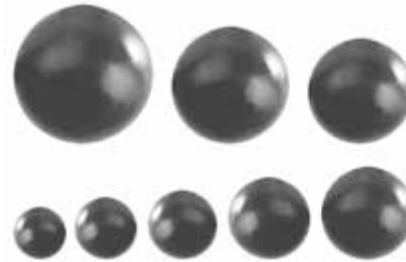

Art. 13.251.30	Ø 30 mm.
Art. 13.251.35	Ø 35 mm.
Art. 13.251.40	Ø 40 mm.
Art. 13.251.50	Ø 50 mm.
Art. 13.251.60	Ø 60 mm.
Art. 13.251.70	Ø 70 mm.
Art. 13.251.80	Ø 80 mm.
Art. 13.251.90	Ø 90 mm.
Art. 13.251.100	Ø 100 mm.
Art. 13.251.120	Ø 120 mm.
Art. 13.251.150	Ø 150 mm.
Art. 13.251.200	Ø 200 mm.

Si raccomanda di zincare a caldo le sfere vuote in lamiera solo dopo averle forate
It's recommended to perforate the Hollow Spheres before the hot galvanization

Sfere Schiacciate / Crushed Spheres

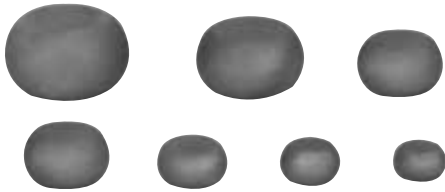

H.50 X L.80 mm. Art. 13.252	H.40 X L.70 mm. Art. 13.253	H.35 X L.55 mm. Art. 13.254
H.28 X L.45 mm. Art. 13.255	H.26 X L.40 mm. Art. 13.256	H.22 X L.35 mm. Art. 13.257

Sfere Forgiate Diamantate / Diamond Forged Spheres

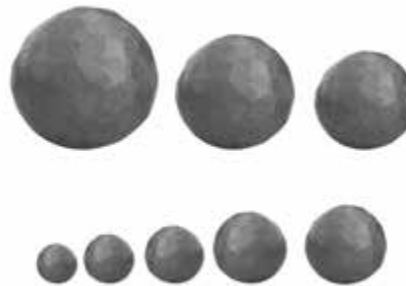

Art. 13.252.20	Ø 20 mm.
Art. 13.252.25	Ø 25 mm.
Art. 13.252.30	Ø 30 mm.
Art. 13.252.35	Ø 35 mm.
Art. 13.252.40	Ø 40 mm.
Art. 13.252.50	Ø 50 mm.
Art. 13.252.60	Ø 60 mm.
Art. 13.252.70	Ø 70 mm.
Art. 13.252.80	Ø 80 mm.
Art. 13.252.90	Ø 90 mm.
Art. 13.252.100	Ø 100 mm.
Art. 13.252.120	Ø 120 mm.
Art. 13.252.150	Ø 150 mm.

Sfere Forgiate / Forged Spheres

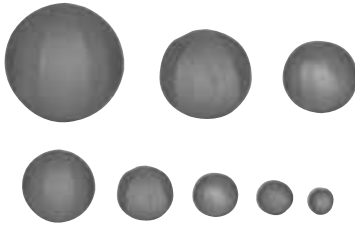

Art. 13.258	Ø 20 mm.
Art. 13.259	Ø 25 mm.
Art. 13.260	Ø 30 mm.
Art. 13.261	Ø 35 mm.
Art. 13.262	Ø 40 mm.
Art. 13.263	Ø 50 mm.
Art. 13.264	Ø 60 mm.
Art. 13.265	Ø 70 mm.
Art. 13.266	Ø 80 mm.
Art. 13.267	Ø 90 mm.
Art. 13.268	Ø 100 mm.

Mezze sfere vuote in lamiera / Half hollow spheres in iron sheet

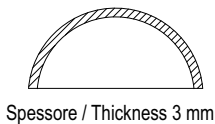

Spessore / Thickness 3 mm



Art. 13.251.40H	Ø 40 mm
Art. 13.251.50H	Ø 50 mm
Art. 13.251.60H	Ø 60 mm
Art. 13.251.70H	Ø 70 mm
Art. 13.251.80H	Ø 80 mm
Art. 13.251.90H	Ø 90 mm
Art. 13.251.100H	Ø 100 mm
Art. 13.251.120H	Ø 120 mm
Art. 13.251.150H	Ø 150 mm
Art. 13.251.200H	Ø 200 mm.

Sfere Piene Forate / Holed Solid Spheres

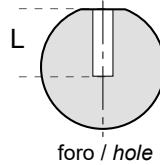

foro / hole

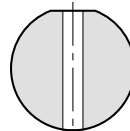

foro passante
passing hole



Ø 25 mm.

Art. 13.242.F12
foro / hole Ø 12,5 mm. x L. 12,5
Art. 13.242.F12H
foro passante / passing hole
Ø 12,5 mm.



Ø 35 mm.

Art. 13.244.F12
foro / hole Ø 12,5 mm. x L. 15
Art. 13.244.F12H
foro passante / passing hole
Ø 12,5 mm.

Ø 30 mm.
Art. 13.243.F12
foro / hole Ø 12,5 mm. x L. 15
Art. 13.243.F12H
foro passante / passing hole
Ø 12,5 mm.

Art. 13.244.F14
foro / hole Ø 14,5 mm. x L. 15
Art. 13.244.F14H
foro passante / passing hole
Ø 14,5 mm.

Art. 13.244.F16
foro / hole Ø 16,5 mm. x L. 15
Art. 13.244.F16H
foro passante / passing hole
Ø 16,5 mm.

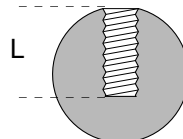

L

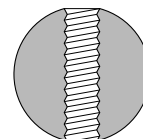

Sfere Piene Forate e Filettate / Solid Spheres with Threaded Hole

Art. 13.268.50	Ø 12 mm.	Filetto / Threaded M6 cieco x L 9
Art. 13.268.51	Ø 12 mm.	Filetto / Threaded M6 passante / passing
Art. 13.268.60	Ø 16 mm.	Filetto / Threaded M8 cieco x L 12
Art. 13.268.61	Ø 16 mm.	Filetto / Threaded M8 passante / passing
Art. 13.268.65	Ø 20 mm.	Filetto / Threaded M10 cieco x L 16
Art. 13.268.66	Ø 20 mm.	Filetto / Threaded M10 passante / passing

Pomoli in Ottone / Brass Knobs

H.55 X L.42 mm.
Art. 13.271
base 30 mm.
Filettato MA 10
Threaded MA 10



H.80 X L.55 mm
Art. 13.272
base 42 mm
Filettato MA 14
Threaded MA 14



H.100 X L.60 mm
Art. 13.273.01
foro Ø 25,5 mm
base 30 mm
Filettato MA 10
Threaded MA 10

**Pomoli in cristallo /
Crystal Knobs**

Fissaggio con granello / Fastening with dowel



H.100 X L.65 mm.
Art. 13.273.05
Ø foro 35,5 mm.
base 50 mm.



H.40 X L.25 mm.
Art. 13.273.09
base 18 mm.

Filettato MA 4
With Threaded MA 4



H.60 mm.
Art. 13.274 Ø 12,5 mm. L.30
Art. 13.275 Ø 14,5 mm. L.32
Art. 13.276 Ø 16,5 mm. L.33
Art. 13.277 Ø 18,5 mm. L.35



H.60 mm.
Art. 13.278 Ø 12,5 mm. L.29
Art. 13.279 Ø 14,5 mm. L.31
Art. 13.280 Ø 16,5 mm. L.33
Art. 13.281 Ø 18,5 mm. L.36



H.40 X L.25 mm.
Art. 13.282 Ø 12,5 mm.
Art. 13.283 Ø 14,5 mm.
Art. 13.284 Ø 16,5 mm.
Art. 13.285 Ø 18,5 mm.



H.26 mm.
Art. 13.286 Ø 12,5 mm. L.30
Art. 13.287 Ø 14,5 mm. L.32



H.26 mm.
Art. 13.290 Ø 12,5 mm. L.29
Art. 13.291 Ø 14,5 mm. L.31

Fissaggio con granello / Fastening with dowel



H.26 X L.30 mm.
Art. 13.293.01
Ø foro 12,5 mm.
H.26 X L.32 mm.
Art. 13.293.02
Ø foro 14,5 mm.
H.26 X L.33 mm.
Art. 13.293.03
Ø foro 16,5 mm.
H.26 X L.35 mm.
Art. 13.293.04
Ø foro 18,5 mm.



H.60 X L.32 mm.
Art. 13.293.06
Ø foro 14,5 mm.
H.60 X L.33 mm.
Art. 13.293.07
Ø foro 16,5 mm.

H.60 X L.35 mm
Art. 13.293.08
Ø foro 18,5

NEW



H.26 X L.29 mm.
Art. 13.293.09
Ø foro 12,5 mm.
H.26 X L.31 mm.
Art. 13.293.10
Ø foro 14,5 mm.
H.26 X L.33 mm.
Art. 13.293.11
Ø foro 16,5 mm.
H.26 X L.36 mm.
Art. 13.293.12
Ø foro 18,5 mm.



H.60 X L.29 mm.
Art. 13.293.13
Ø foro 12,5 mm.
H.60 X L.33 mm.
Art. 13.293.15
Ø foro 16,5 mm.
H.60 X L.36 mm.
Art. 13.293.16
Ø foro 18,5 mm.



H.25 X L.35 mm.
Art. 13.294 Ø 14,5 mm.
Art. 13.295 Ø 12,5 mm.



H.83 X L.35 mm.
Art. 13.296
Ø foro 12,5 mm.
H.83 X L.35 mm.
Art. 13.296.01
Ø foro 14,5 mm.

Fissaggio con granello
Fastening with dowel



H.90 X L.20 mm.
Art. 13.297
Ø foro 12,5 mm.
Fissaggio con granello
Fastening with dowel

Fissaggio con granello / Fastening with dowel



H.42 X L.50 mm.
Art. 13.297.02
Ø foro 30,5 mm.
Fissaggio con granello
Fastening with dowel



H.55 X L.50 mm.
Art. 13.297.03
Ø foro 20,5 mm.
H.55 X L.50 mm.
Art. 13.297.04
Ø foro 25,5 mm.

Fissaggio con granello
Fastening with dowel



H.119 X L.48 mm.
Art. 13.297.05
Ø foro 30,5 mm.
Fissaggio con granello
Fastening with dowel



H.120 X L.65 mm.
Art. 13.297.06
Ø foro 25,5 mm.
H.120 X L.65 mm.
Art. 13.297.07
Ø foro 30,5 mm.

Fissaggio con granello
Fastening with dowel



H.260 X L.50 mm.
Art. 13.297.09
Ø foro 25,5 mm.
Fissaggio con granello
Fastening with dowel



H.55 X L.63 mm.
Art. 13.297.10
Ø foro 25,5 mm.
H.60 X L.73 mm.
Art. 13.297.11
Ø foro 30,5 mm.
H.60 X L.73 mm.
Art. 13.297.12
Ø foro 35,5 mm.

Fissaggio con granello / Fastening with dowel



H.20 X Base 80 X 80 mm.
Art. 13.297.15
□ foro 25,5 mm.



H.13 X Base 24 X 24 mm.
Art. 13.297.17
□ foro 14,5 mm.



H.15 X Base 30 X 30 mm.
Art. 13.297.18
□ foro 20,5 mm.



Art. 13.297.19



H.50 X L.33 mm.
Art. 13.298 Ø 22 mm
H.50 X L.37 mm.
Art. 13.299 Ø 30 mm

BORCHIE, LANCE E PIASTRE STUDS, SPEARS AND PLATES

H.110 X L.110 mm. - sp.10 mm.
Art. 13.300 □ foro 26 mm.
Art. 13.301 □ foro 31 mm.

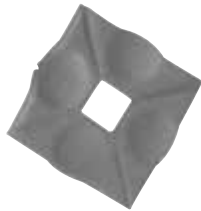

H.70 X L.70 mm. - sp.8 mm.
Art. 13.304 □ foro 16,5 mm.
Art. 13.305 □ foro 21 mm.

H.50 X L.50 mm. - sp. 6 mm.
Art. 13.306 □ foro 12,5 mm.
Art. 13.306.01 □ foro 14,5 mm.
Art. 13.307 □ foro 16,5 mm.

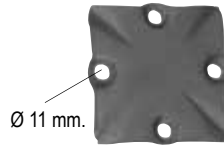

H.100 X L.100 mm.
Art. 13.308
Spessore 10 mm.



H.100 X L.100 mm.
Art. 13.309
Spessore 10 mm.

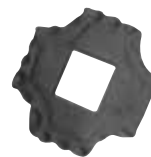

H.70 X L.70 mm. - sp.4 mm.
Art. 13.310 □ Foro 24 mm.

NEW



H.80 X L.80 mm.
Art. 13.310.10
Spessore 8 mm.



H.100 X L.100 mm.
Art. 13.311
Spessore 10 mm.



H.100 X L.100 mm. - sp.10 mm.
Art. 13.312 □ Foro 25 mm.
Art. 13.312.01 □ Foro 40 mm. **NEW**
Art. 13.313 □ Foro 30 mm.

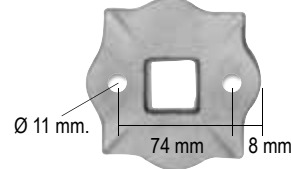

H.100 X L.100 mm. - sp.10 mm.
Art. 13.313.2F □ Foro 30 mm. **NEW**



H.22 mm.
Art. 13.313.01
Base 120 mm.



H.22 X Base 120 mm.
Art. 13.313.02 Ø Foro 50,5 mm.
Art. 13.313.03 Ø Foro 65,5 mm.
Art. 13.313.04 Ø Foro 80,5 mm.



H.20 mm.
Art. 13.314 Base 80 mm.
Art. 13.315 Base 60 mm.
Art. 13.316 Base 50 mm.
Art. 13.317 Base 40 mm.
Art. 13.318 B. 30 X 35 mm.

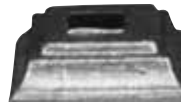

Base 80 X 80 H.20 mm.
Art. 13.319 □ Foro 30,5 mm.
Art. 13.320 □ Foro 35,5 mm.
Art. 13.321 □ Foro 40,5 mm.

Base 60 X 60 H.20 mm.
Art. 13.322 □ Foro 25,5 mm.
Art. 13.323 □ Foro 30,5 mm.

Base 50 X 50 H.20 mm.
Art. 13.324 □ Foro 16,5 mm.
Art. 13.325 □ Foro 18,5 mm.
Art. 13.326 □ Foro 20,5 mm.

Base 40 X 40 H.20 mm.
Art. 13.327 □ Foro 12,5 mm.
Art. 13.328 □ Foro 14,5 mm.
Art. 13.329 □ Foro 16,5 mm.

Base 30 X 30 H.20 mm.
Art. 13.330 □ Foro 12,5 mm.
Art. 13.331 □ Foro 14,5 mm.
Art. 13.332 □ Foro 12X15 mm.

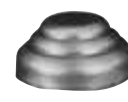

Art. 13.333
Base Ø 80 mm.

Art. 13.334
Base Ø 60 mm.

Art. 13.335
Base Ø 50 mm.

Art. 13.336
Base Ø 40 mm.

Art. 13.337
Base Ø 30 mm.

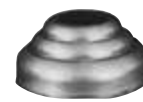

H. 20 mm.
Base Ø 80 mm.
Art. 13.338 Ø Foro 30,5 mm.
Art. 13.339 Ø Foro 35,5 mm.
Art. 13.340 Ø Foro 40,5 mm.

Base Ø 60 mm.
Art. 13.341 Ø Foro 25,5 mm.
Art. 13.342 Ø Foro 30,5 mm.

Base Ø 50 mm.
Art. 13.343 Ø Foro 16,5 mm.
Art. 13.344 Ø Foro 18,5 mm.
Art. 13.345 Ø Foro 20,5 mm.

Base Ø 40 mm.
Art. 13.346 Ø Foro 12,5 mm.
Art. 13.347 Ø Foro 14,5 mm.
Art. 13.348 Ø Foro 16,5 mm.

Base Ø 30 mm.
Art. 13.349 Ø Foro 12,5 mm.
Art. 13.350 Foro ovale 12,5 mm.

Elementi in Ottone / Brass Studs



H.250 mm. □ 14 mm.
Art. 13.350.03
H.250 mm. □ 16 mm.
Art. 13.350.04



H. 95 X L. 47 mm.
Art. 13.351
Base Ø 34 mm.
(filettato MA 8)

H. 115 X L. 65 mm.
Art. 13.352
Base Ø 40 mm.
(filettato MA 10)



H. 63 X L. 42 mm.
Art. 13.353
Base Ø 30 mm.
(filettato MA 8)



H. 70 X L. 40 mm.
Art. 13.356
Base Ø 25 mm.
(filettato MA 8)

H. 95 X L. 45 mm.
Art. 13.357
Base Ø 38 mm.
(filettato MA 10)

H. 110 X L. 55 mm.
Art. 13.358
Base Ø 40 mm.
(filettato MA 10)

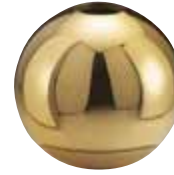

Art. 13.359
Sfera Ø 35 mm.
Foro Ø 14 mm.

Art. 13.360
Sfera Ø 45 mm.
Foro Ø 14 mm.

Art. 13.361
Sfera Ø 55 mm.
Foro Ø 14 mm.



Art. 13.362
Sfera Ø 45 mm.
Foro □14 mm.

Art. 13.363
Sfera Ø 55 mm.
Foro □14 mm.

Fissaggio con granello
Fastening with dowel
Foro passante
Passing hole

Fissaggio con granello / Fastening with dowel



H.20 X L.40 mm.
Art. 13.364
Foro Ø 16 mm.



H.80 X L.40 mm.
Art. 13.365
Foro Ø 16 mm.



H.120 X L.40 mm.
Art. 13.366
Foro Ø 16 mm.



H.100 X L.30 mm.
Art. 13.367 □14
Art. 13.368 □16

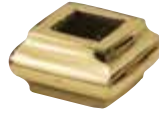

H.20 X L.35 mm.
Art. 13.369 □14



H.35 X L.38 mm.
Art. 13.373 □14
Art. 13.374 □16



H. 130 X L. 46 mm.
Art. 13.375
Ø 16 mm.
NEW



H.75 X L.40 mm.
Art. 13.376
Foro Ø 16 mm.



H.30 X L.40 mm.
Art. 13.377
Foro Ø 16 mm.



H.260 X L.50 mm.
Art. 13.378
Foro Ø 20 mm.



H.130 X L.50 mm.
Art. 13.379
Foro Ø 20 mm.



H.190 X L.70 mm.
Art. 13.380
Foro Ø 16 mm.



H.135 X L.40 mm.
Art. 13.381
Foro Ø 16 mm.



H.75 X L.40 mm.
Art. 13.382
Foro Ø 16 mm.



H.30 X L.40 mm.
Art. 13.383
Foro Ø 16 mm.



H.150 X L.50 mm.
Art. 13.384
Foro □16 mm.



H.60 X L.45 mm.
Art. 13.385
Foro □16 mm.



H.45 X L.40 mm.
Art. 13.393
Foro Ø16 mm.



H.45 X L.40 mm.
Art. 13.394
Foro Ø16 mm.



Sfera vuota filettata internamente
Internally-threaded empty sphere

H. 46 mm. MA 10
Art. 13.386 Ø 45 mm.

H.72 mm. MA 10
Art. 13.389 Ø 75 mm.

H.83 mm. MA 10
Art. 13.390 Ø 85 mm.

Borchie in ottone / Brass studs
Fissaggio con granello / Fastening with dowel



H.105 X L.40 mm.
Art. 13.400 Foro Ø 12,5mm.
Art. 13.400.01 Foro Ø 14,5mm.
Art. 13.400.02 Foro Ø 16,5mm.



H.75 X L.40 mm.
Art. 13.401 Foro Ø 12,5mm.
Art. 13.401.01 Foro Ø 14,5mm.
Art. 13.401.02 Foro Ø 16,5mm.



H.30 X L.40 mm
Art. 13.402.01 Ø foro 14,5 mm
Art. 13.402.01 Ø foro 16,5 mm

Distanziali regolabili / Adjustable support



Ferro zincato / Iron
H.23 - 33 mm
Art. 13.510 Ø 30 - foro10,5
H.23 - 33 mm
Art. 13.511 Ø 35 - foro14,5



Ferro zincato / Iron
H.30 - 40 mm
Art. 13.514 Ø 30 - foro14,5
H.30 - 40 mm
Art. 13.515 Ø 35 - foro14,5



Ferro zincato / Iron
H.32 - 42 mm
Art. 13.518 Ø 30 - foro10,5
H.32 - 42 mm
Art. 13.519 Ø 35 - foro14,5



Ferro zincato / Iron
H.45 - 65 mm
Art. 13.522 Ø 30 - foro14,5
H.45 - 65 mm
Art. 13.523 Ø 35 - foro14,5



Spessore 3 mm.
Art. 14.001 Ø 95 mm.



Spessore 3 mm.
Art. 14.002 Ø 95 mm.



Spessore 3 mm.
Art. 14.003 Ø 95 mm.



Spessore 3 mm.
Art. 14.003.01 Ø 68 mm.
Art. 14.003.02 Ø 97 mm.

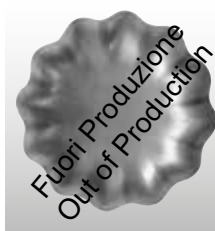

Spessore 2 mm
Art. 14.003.04 Ø 95 mm



Spessore 3 mm.
Art. 14.004 Ø 63 mm.



Spessore 5 mm
Art. 14.005 Ø 93 mm.



Spessore 0,8 mm.
Art. 14.005.01 Ø 77 mm.



H. 10 Spessore 0,8 mm
Art. 14.005.03 Ø 85 mm.
Foro Ø 10 mm.



H. 35 Spessore 2 mm
Art. 14.005.04 Ø 135 mm.
Foro Ø 11 mm.



H. 17 Spessore 0,5 mm
Art. 14.005.05 Ø 80 mm.
Foro Ø 10 mm.



Spessore 3 mm.
Art. 14.005.06 Ø 60 mm.
Foro Ø 10 mm.



Spessore 3 mm.
Art. 14.005.07 Ø 90 mm.
Foro Ø 10 mm.



H.21 - Spessore 1 mm.
Art. 14.005.08 Ø 105 mm.
Foro Ø 10 mm.



H.10 - Spessore 10 mm.
Art. 14.005.09 Ø 65 mm.
Foro Ø 12,5 mm.



Spessore 3 mm.
Art. 14.006 Ø 65 mm.



Spessore 3 mm
Art. 14.007 Ø 92 mm.



Spessore 3 mm
Art. 14.008 Ø 118 mm.



Spessore 3 mm
Art. 14.010 Ø 98 mm.



Spessore 3 mm
Art. 14.011 Ø 122 mm.



Spessore 3 mm
Art. 14.012 Ø 60 mm.



Spessore 3 mm
Art. 14.013 Ø 90 mm.



Spessore 3 mm.
Art. 14.014 Ø 60 mm.



Spessore 3 mm.
Art. 14.014.01 Ø 62 mm.

NEW



Spessore/Thickness 2,5 mm.
Art. 14.014.02 Ø 60

NEW



Spessore/Thickness 2,5 mm.
Art. 14.014.03 Ø 95

NEW



Spessore/Thickness 2,5 mm.
Art. 14.014.04 Ø 95



Spessore 3 mm.
Art. 14.015 Ø 95 mm.
Art. 14.015.01 Ø 120 mm.

NEW



Spessore 2 mm.
Art. 14.016 Ø 60 mm.

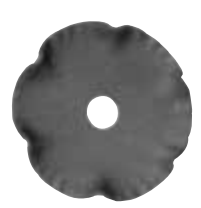

Spessore 2 mm.
Art. 14.017 Ø 60 mm.



Spessore 1 mm.
Art. 14.018 Ø 37 mm.



Fuori Produzione
Out of Production
Spessore 5 mm
Art. 14.018.01 Ø 60 mm.
Foro Ø 10 mm.



Fuori Produzione
Out of Production
Spessore 3 mm
Art. 14.018.02 Ø 40 mm.



Spessore 2 mm.
Art. 14.019 Ø 60 mm.



Fuori Produzione
Out of Production
Spessore 3 mm
Art. 14.019.01 Ø 65 mm.



Fuori Produzione
Out of Production
Spessore 3 mm
Art. 14.019.02 Ø 60 mm.



Spessore 7 mm.
Art. 14.020 Ø 68 mm.



Spessore 2 mm.
Art. 14.021 Ø 90 mm.



Spessore 2 mm.
Art. 14.021.01 Ø 135 mm.
Foro Ø 10 mm.



Spessore 2 mm.
Art. 14.022 Ø 85 mm.



Spessore 2 mm
Art. 14.023 Ø 85 mm.

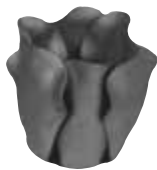

H.40 - Spessore 0,5 mm.
Art. 14.024 Ø 40 mm.

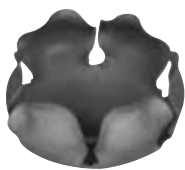

H.35 - Spessore 0,5 mm.
Art. 14.025 Ø 55 mm.

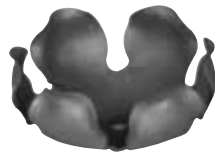

H.30 - Spessore 0,5 mm.
Art. 14.026 Ø 65 mm.

Esempio unito non saldato
United example not welded

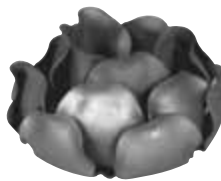

H.50 mm. - Spessore 2 mm.
Art. 14.026.01 Ø 75 mm.
Foro Ø 10 mm.

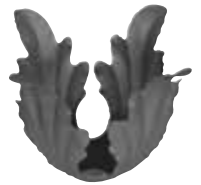

H.70 mm. - Spessore 0,6 mm.
Art. 14.027 Ø 90 mm.



Fuori Produzione
Out of Production
Spessore 3 mm
Art. 14.027.02 Ø 60 mm.



Fuori Produzione
Out of Production
Spessore 2 mm
Art. 14.027.03 Ø 68 mm



Fuori Produzione
Out of Production
Spessore 2 mm
Art. 14.027.04 Ø 95 mm



H. 42 - Spessore 0,6 mm.
Art. 14.030 Ø 40 mm.



Fuori Produzione
Out of Production
Spessore 3 mm
Art. 14.032.01 Ø 130 mm.

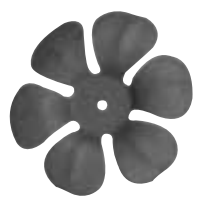

Spessore 0,6 mm.
Art. 14.034 Ø 65 mm.



Spessore 1 mm.
Art. 14.034.01 Ø 70 mm.

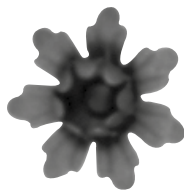

Spessore 0,5 mm.
Art. 14.035 Ø 42 mm.

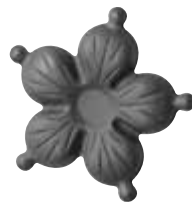

Spessore 3 mm.
Art. 14.035.01 Ø 110 mm.



H 45 mm-Spessore 1,5 mm.
Art. 14.035.02 Ø 35 mm.



H 47 mm-Spessore 1,5 mm.
Art. 14.035.03 Ø 60 mm.



H 135 X L.80 mm
Art. 14.035.04

FIORI E FOGLIE
FLOWERS AND LEAVES



H 325 mm
Art. 14.035.05 Ø 6 mm.



H 325 mm
Art. 14.035.06 Ø 6 mm.



H 325 mm
Art. 14.035.07 Ø 6 mm.



H 325 mm
Art. 14.035.08 Ø 6 mm.



H 180 mm
Art. 14.035.09 Ø 3 mm.

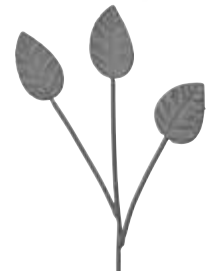

H 180 X L.130 mm
Art. 14.035.10 Ø 3 mm.

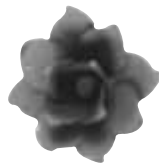
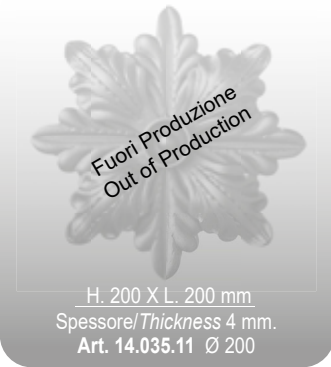

Spessore 0,5 mm.
Art. 14.036 Ø 48 mm.



Spessore 1 mm.
Art. 14.036.01 Ø 70 mm.



H. 45 X L.25 mm.
Art. 14.036.02
Spessore 0,5 mm.



H. 45 X L.30 mm.
Art. 14.036.03
Spessore 1,5 mm.



H. 70 X L.30 mm.
Art. 14.036.04
Spessore 0,5 mm.



H. 115 X L.65 mm.
Art. 14.036.06
Spessore 0,5 mm.



H. 60 X L.50 mm.
Art. 14.036.07
Spessore 0,5 mm.



H. 55 X L.70 mm.
Art. 14.036.08
Spessore 1 mm.



H. 85 X L.45 mm.
Art. 14.037
Spessore 0,5 mm.



H. 83 X L.44 mm.
Art. 14.037.01
Spessore 1 mm.



H. 55 X L.31 mm.
Art. 14.037.02
Spessore 1 mm.



H. 70 X L.35 mm.
Art. 14.038
Spessore 0,5 mm.



H. 82 X L.47 mm.
Art. 14.038.01
Spessore 1 mm.



H. 195 X L.80 mm.
Art. 14.039
Spessore 0,5 mm.



H. 70 X L.78 mm.
Art. 14.039.01
Spessore 3 mm



H. 108 X L.120 mm.
Art. 14.039.02
Spessore 3 mm



H. 145 X L.160 mm.
Art. 14.039.03
Spessore 3 mm.

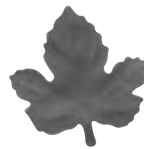

H. 57 X L.55 mm.
Art. 14.040
Spessore 0,6 mm.



H. 75 X L.70 mm.
Art. 14.041
Spessore 0,6 mm.



H. 105 X L.95 mm.
Art. 14.042
Spessore 1 mm.



H. 200 X L.190 mm.
Art. 14.043
Spessore 1 mm.



H. 130 X L.65 mm.
Art. 14.044
Spessore 1 mm.



H. 90 X L.45 mm.
Art. 14.045
Spessore 1 mm.



Tutte le parti di questo catalogo - foto comprese - sono di proprietà Euro-Fer. La riproduzione, anche parziale, è vietata in ogni forma e con ogni mezzo. / Every part of this catalogue - photos included - is Euro-Fer's property. All forms of copying are strictly prohibited.



H. 175 mm.
Art. 14.046.01
Base 22 X 19 mm.



H. 170 X L. 40 mm.
Art. 14.047
Spessore 0,5 mm.



H. 120 X L. 40 mm.
Art. 14.048
Spessore 0,5 mm.



H. 294 X L. 48 mm.
Art. 14.048.01
Spessore 1 mm.



Fuori Produzione
Out of Production
H. 294 X L. 48 mm.
Art. 14.048.02
Spessore 1 mm.



H. 163 X L. 30 mm.
Art. 14.048.03
Spessore 1 mm.



H. 60 X L. 110 mm.
Art. 14.049
Spessore 1 mm.

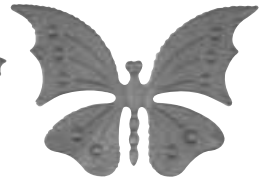

H. 125 X L. 175 mm.
Art. 14.050
Spessore 1 mm.



Fuori Produzione
Out of Production
H. 158 X L. 80 mm.
Art. 14.050.01
Spessore 1 mm.



H. 155 X L. 80 mm.
Art. 14.050.02
Spessore 1 mm.



H. 27 - Spessore 1 mm.
Art. 14.050.03 Ø 150 mm.
Foro Ø 10,5 mm.



H. 45 - Spessore 1 mm.
Art. 14.050.04 Ø 120 mm.
Foro Ø 12,5 mm.



Fuori Produzione
Out of Production
H. 200 X L. 95 mm.
Art. 14.050.05
Spessore 1 mm.



H. 230 X L. 100 mm.
Art. 14.050.06
Spessore 1 mm.



Fuori Produzione
Out of Production
H. 220 X L. 140 mm.
Art. 14.051



H. 220 X L. 140 mm.
Art. 14.052



Fuori Produzione
Out of Production
H. 190 X L. 140 mm.
Art. 14.053



H. 190 X L. 140 mm.
Art. 14.054



H. 180 X L. 130 mm.
Art. 14.055



H. 180 X L. 130 mm.
Art. 14.056



Fuori Produzione
Out of Production
H. 170 X L. 140 mm.
Art. 14.057



H. 170 X L. 140 mm.
Art. 14.058



H. 155 X L. 60 mm.
Art. 14.059
H. 180 X L. 65 mm.
Art. 14.059.01



H. 155 X L. 60 mm.
Art. 14.060
H. 180 X L. 65 mm.
Art. 14.060.01



H. 110 X L. 40 mm.
Art. 14.061



H. 110 X L. 40 mm.
Art. 14.062



H. 90 X L. 30 mm.
Art. 14.063



H. 90 X L. 30 mm.
Art. 14.064



H. 125 X L. 75 mm.
Art. 14.065



H. 125 X L. 75 mm.
Art. 14.066



H. 110 X L. 105 mm.
Art. 14.067



H. 110 X L. 105 mm.
Art. 14.068



H. 80 X L. 60 mm.
Art. 14.069



H. 80 X L. 60 mm.
Art. 14.070



H. 65 X L. 70 mm.
Art. 14.071

NEW



H. 65 X L. 70 mm.
Art. 14.072



H. 55 X L. 70 mm.
Art. 14.073



H. 55 X L. 70 mm.
Art. 14.074



H. 90 X L. 50 mm.
Art. 14.074.01
Spessore 2 mm



H. 90 X L. 50 mm.
Art. 14.074.02
Spessore 2 mm



H.103 X L. 97 mm.
Art. 14.074.03
Spessore 3 mm



H.103 X L. 97 mm.
Art. 14.074.04
Spessore 3 mm



H.280 X L. 450 mm.
Art. 14.078.01
Spessore 4 mm



H. 185 X L.90 mm.
Art. 14.078.02
Spessore 10 mm.

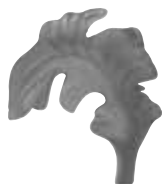

H. 90 X L.75 mm.
Art. 14.075

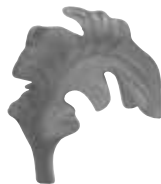

H. 90 X L.75 mm.
Art. 14.076



H. 110 X L.75 mm.
Art. 14.077



H. 110 X L. 75 mm.
Art. 14.078



H. 201 X L. 45 mm.
Art.14.078.04
Spessore 4 mm.



H. 215 X L.110 mm.
Art. 14.079
Spessore 3 mm.



H. 205 X L.100 mm.
Art. 14.080
Spessore 3 mm.



H. 165 X L.70 mm.
Art. 14.081
Spessore 3 mm.



H. 125 X L.82 mm.
Art. 14.082
Spessore 3 mm.



H. 140 X L.85 mm.
Art. 14.083
Spessore 3 mm.



Base Ø 76 mm.
Art. 14.083.01
Spessore 20 mm.



Base Ø 90 mm.
Art. 14.083.02
Spessore 8 mm.
Base Ø 55 mm.
Art. 14.083.03
Spessore 8 mm.



H.18 X L.35 mm.
Art. 14.083.04



Base Ø 125 mm.
Art. 14.083.05
Spessore 15 mm.
Base Ø 90 mm.
Art. 14.083.06
Spessore 12 mm.
Base Ø 55 mm.
Art. 14.083.07
Spessore 8 mm.



H. 185 X L.100 mm.
Art. 14.084
Spessore 10 mm.



H. 80 X L.70 mm.
Art. 14.084.01
Spessore 3 mm.

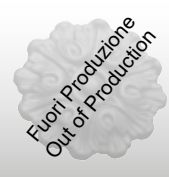

Base Ø100 mm.
Art.14.084.02
Spessore 3 mm.



H. 135 x L.85 mm
Art.14.084.03 / Dx
Spessore 3 mm.



H. 130 X L.75 mm.
Art. 14.087
Spessore 5 mm.



Foglie Forgiate
Forged Leaves

H. 260 X L.45 mm.
Art. 14.087.01
Spessore 5 mm. circa



Foglie Forgiate
Forged Leaves

H. 400 X L.60 mm.
Art. 14.087.02
Spessore 8 mm. circa



Foglie Forgiate
Forged Leaves

H. 420 X L.90 mm.
Art. 14.087.03
Spessore 8 mm. circa



Foglie Forgiate
Forged Leaves

H.270 X L.60 mm.
Art. 14.087.04
Spessore 8 mm. circa



H. 115 X L.100 mm.
Art. 14.084.04 / Dx
Art. 14.084.06 / Sx
Spessore 3 mm.



H. 97 X L.55 mm.
Art. 14.087.05
Spessore 4 mm



H. 90 X L.55 mm.
Art. 14.087.06
Spessore 4 mm



H. 240 X L.77 mm.
Art. 14.087.07
Spessore 4 mm



H.225 X L.60 mm.
Art. 14.087.08
Spessore 4 mm.



H.190 X L.45 mm.
Art. 14.087.09
Spessore 4 mm.

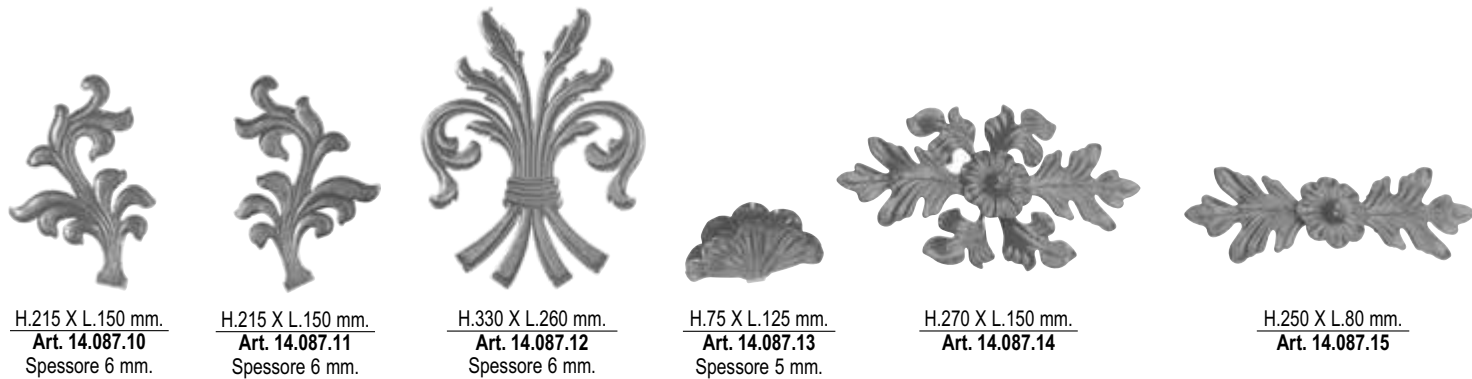

H.215 X L.150 mm.
Art. 14.087.10
Spessore 6 mm.

H.215 X L.150 mm.
Art. 14.087.11
Spessore 6 mm.

H.330 X L.260 mm.
Art. 14.087.12
Spessore 6 mm.

H.75 X L.125 mm.
Art. 14.087.13
Spessore 5 mm.

H.270 X L.150 mm.
Art. 14.087.14

H.250 X L.80 mm.
Art. 14.087.15

Decorazioni in Acciaio e Ottone / Brass and Steel Decorations



Base Ø97 Ottone
Art. 14.088
Spessore 2 mm.



Base Ø 97 Acciaio
Art. 14.089
Spessore 1,5 mm.



H.80 X L.70 mm.
Art. 14.090
Ottone-Spessore 2 mm.



H.80 X L.70 mm.
Art. 14.091
Acciaio-Spessore 1,5 mm.



H.115 X L.100 mm.
Art. 14.092 Ottone-Sp. 2 mm./dx
Art. 14.092.01 Ottone-Sp. 2 mm./sx
Art. 14.093 Acciaio-Sp. 1,5 mm./dx
Art. 14.093.01 Acciaio-Sp. 1,5 mm./sx



H.135 X L.85 mm.
Art. 14.094 Ottone-Sp. 2 mm./dx
Art. 14.094.01 Ottone-Sp. 2 mm./sx
Art. 14.095 Acciaio-Sp. 1,5 mm./dx
Art. 14.095.01 Acciaio-Sp. 1,5 mm./sx



Base Ø 100 mm.
Art. 14.097 Acciaio-Sp. 1,5 mm.



H.90 X L.30 mm.
Art. 14.098 Ottone-Sp. 2 mm./dx
Art. 14.098.01 Ottone-Sp. 2 mm./sx
Art. 14.099 Acciaio-Sp. 1,5 mm./dx
Art. 14.099.01 Acciaio-Sp. 1,5 mm./sx



H.115X L.50 mm.
Art. 14.100 Ottone-Sp. 2 mm./dx
Art. 14.100.01 Ottone-Sp. 2 mm./sx
Art. 14.101 Acciaio-Sp. 1,5 mm./dx
Art. 14.101.01 Acciaio-Sp. 1,5 mm./sx



H.75X L.65 mm.
Art. 14.102 Ottone-Sp. 2 mm./dx
Art. 14.102.01 Ottone-Sp. 2 mm./sx
Art. 14.103 Acciaio-Sp. 1,5 mm./dx
Art. 14.103.01 Acciaio-Sp. 1,5 mm./sx



Filettato / Threaded MA 5.
H. 95 X L.95 mm.
Art. 14.106



Filettato / Threaded MA 4
H. 10 X Ø 40
Art. 14.107



Filettato / Threaded MA 4
H.7 X Ø 38 mm.
Art. 14.108



Filettato / Threaded MA 4
H.7 X Ø 66 mm.
Art. 14.109



H.18 - Spessore 4 mm.
Art. 14.109.01 Ø 60 mm.
Foro/Hole Ø 6 mm.



Filettato / Threaded MA 6
Spessore 8 mm.
Art. 14.109.02 Ø 55 mm.



Filettato / Threaded MA 6
Spessore 13 mm.
Art. 14.109.03 Ø 78 mm.



Tutte le parti di questo catalogo - foto comprese - sono di proprietà Euro-Fer. La riproduzione, anche parziale, è vietata in ogni forma e con ogni mezzo. / Every part of this catalogue - photos included - is Euro-Fer's property. All forms of copying are strictly prohibited.

Decorazioni in Acciaio e Ottone Brass and Steel Decorations



Filettato / Threaded MA 6
H.85 X L.55mm.
Art. 14.109.04
Spessore/Thickness 4 mm.



Spessore 2 mm.
Art. 14.110 Ø 20 mm.
Art. 14.111 Ø 25 mm.
Art. 14.112 Ø 30 mm.
Art. 14.113 Ø 35 mm.
Art. 14.114 Ø 40 mm.
Art. 14.115 Ø 50 mm.
Art. 14.116 Ø 60 mm.

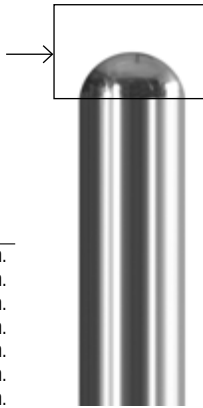

H.200 X L.70 mm.
Art. 14.151



H.200 X L.60 mm.
Art. 14.152



Filettato / Threaded MA 8
H.115 X L.58 mm.
Art. 14.118 Ø 20 mm
H.140 X L.70 mm. MA8
Art. 14.119 Ø 26 mm



Filettato / Threaded MA 8
H.150 X L.60 mm.
Art. 14.120 Ø 25 mm



H.180 X L.60 mm.
Art. 14.153



H. 300 X L.45 mm
Art. 14.160
Ø 6 mm



H. 195 X L.43 mm
Art. 14.160.01
Ø 6 mm





Gli articoli della Linea Liberty possono includere particolari in ghisa o ferro fuso.
The items of the Liberty Line could contain casting parts.

NEW



Sinistro / Left
H. 200 X L. 165 mm
Art. 14.198
Spessore 4 mm



Destro / Right
H. 200 X L. 165 mm
Art. 14.199
Spessore 4 mm



Sinistro / Left
H. 180 X L. 175 mm
Art. 14.200
Spessore 4 mm



Destro / Right
H. 195 X L. 175 mm
Art. 14.201
Spessore 4 mm



Sinistro / Left
H. 130 X L. 61 mm
Art. 14.202
Spessore 4 mm



Destro / Right
H. 130 X L. 61 mm
Art. 14.203
Spessore 4 mm



Sinistro / Left
H. 175 X L. 175 mm
Art. 14.204
Spessore 6 mm



Destro / Right
H. 175 X L. 175 mm
Art. 14.205
Spessore 6 mm



Sinistro / Left
H. 110 X L. 175 mm
Art. 14.206
Spessore 5 mm



Destro / Right
H. 110 X L. 175 mm
Art. 14.207
Spessore 5 mm



Sinistro / Left
H. 190 X L. 180 mm
Art. 14.208
Spessore 7 mm



Destro / Right
H. 190 X L. 180 mm
Art. 14.209
Spessore 7 mm



Sinistro / Left
H. 110 X L. 165 mm
Art. 14.210
Spessore 5 mm



Destro / Right
H. 110 X L. 165 mm
Art. 14.211
Spessore 5 mm



Sinistro / Left
H. 175 X L. 135 mm
Art. 14.212
Spessore 5 mm



Destro / Right
H. 175 X L. 135 mm
Art. 14.213
Spessore 5 mm



Sinistro / Left
H. 230 X L. 130 mm
Art. 14.214



Destro / Right
H. 230 X L. 130 mm
Art. 14.215



Sinistro / Left
H. 95 X L. 100 mm
Art. 14.216
Spessore 5 mm



Destro / Right
H. 95 X L. 100 mm
Art. 14.217
Spessore 5 mm



Sinistro / Left
H. 125 X L. 90 mm
Art. 14.218
Spessore 6 mm



Destro / Right
H. 125 X L. 90 mm
Art. 14.219
Spessore 6 mm



Sinistro / Left
H. 160 X L.130 mm
Art. 14.220
Spessore 3,75 mm



Destro / Right
H. 160 X L.130 mm
Art. 14.221
Spessore 3,75 mm



Sinistro / Left
H. 110 X L.95 mm
Art. 14.222



Destro / Right
H. 110 X L.95 mm
Art. 14.223

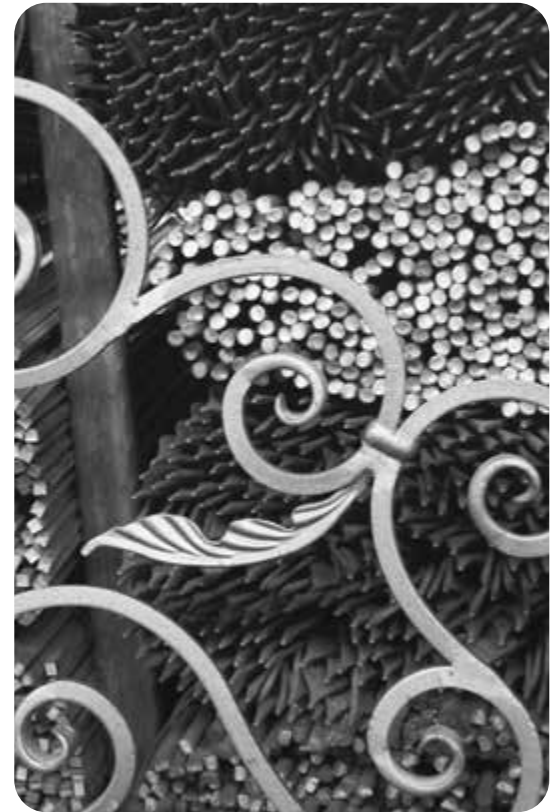

Sinistro / Left
H. 90 X L.70 mm
Art. 14.224
Spessore 3,5 mm



Destro / Right
H. 90 X L.70 mm
Art. 14.225
Spessore 3,5 mm



Sinistro / Left
H. 80 X L.65 mm
Art. 14.226
Spessore 4 mm



Destro / Right
H. 80 X L.65 mm
Art. 14.227
Spessore 4 mm



Ø 118 mm
Art. 14.250
Spessore 5 mm



Ø 90 mm
Art. 14.251
Spessore 3,5 mm



Ø 95 mm
Art. 14.252
Spessore 5 mm



H.140 X L.110 mm
Art. 14.253



Ø 50 mm
Art. 14.254
Spessore 3 mm



H.290 X L.65 mm
Art. 14.270
Spessore 3,5 mm



H.240 X L.50 mm
Art. 14.271
Spessore 5 mm





H. 175 X L.60 mm.
Art. 15.001
Spessore 10 mm.



H. 135 X L.45 mm.
Art. 15.002
Spessore 10 mm.



H.165 x L.55 mm.
Art. 15.003
Spessore 10 mm



Martellato / Hammered
Art. 15.003.01
≠ 30 X 8 mm.

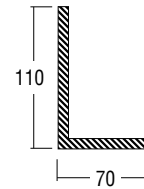

Martellato / Hammered
Art. 15.003.02
≠ 40 X 8 mm.



Martellato / Hammered
H. 300 X L.40 mm.
Art. 15.003.03
≠ 25 X 8 mm.



Martellato / Hammered
H. 300 X L.45 mm.
Art. 15.003.04
≠ 30 X 8 mm.



Martellato / Hammered
H. 300 X L.55 mm.
Art. 15.003.05
≠ 40 X 8 mm.



H. 180 X L.85 mm.
Art. 15.003.06 Ø 12 mm.



H. 180 X L.85 mm.
Art. 15.003.07 □ 10 mm.

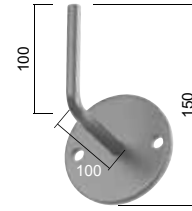

Piastra/Plate Ø 100 ≠ 8 mm.
Art. 15.003.08 Ø 12 mm.
forata / holed

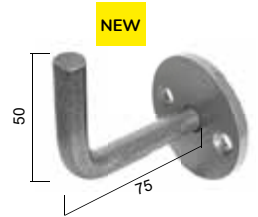

Piastra/Plate Ø 60 ≠ 5 mm.
Art. 15.003.09 Ø 12 mm.
forata / holed



H. 180 X L.95 mm.
Art. 15.004 □ 14 X 14 mm.



H.180 L.95 mm.
Art. 15.004.01 Ø 14 mm.



H. 120 X L.130 mm.
Art. 15.005 □ 14 X 14 mm.

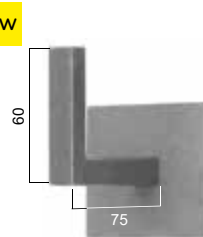

Piastra/Plate
H.60 X 60 mm. ≠ 5 mm.
Art. 15.005.10 □ 12 mm.

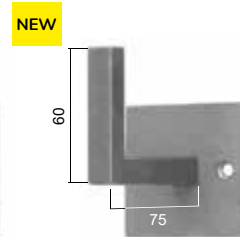

Piastra/Plate
H.60 X 60 mm. ≠ 5 mm.
Art. 15.005.11 □ 12 mm.
forata / holed

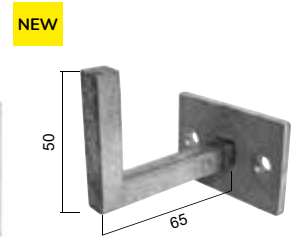

Piastra/Plate
H.40 X 60 mm. ≠ 5 mm.
Art. 15.005.13 □ 10 mm.
forata / holed



H. 500 mm.
Art. 15.006.01 ≠ 80 X 8 mm.
Art. 15.006.02 ≠ 100 X 8 mm.
Art. 15.006.03 ≠ 120 X 8 mm.



H. 500 mm.
Art. 15.006.07 ≠ 80 X 8 mm.
Art. 15.006.08 ≠ 100 X 8 mm.
Art. 15.006.09 ≠ 120 X 8 mm.



H. 240 X L.140 mm.
Art. 15.006 □ 12 X 12 mm.



Martellato / Hammered
H. 300 mm.
Art. 15.006.13 □ 12 mm.



H. 420 X L. 270 mm.
Art. 15.006.14 ≠ 50 X 8 mm

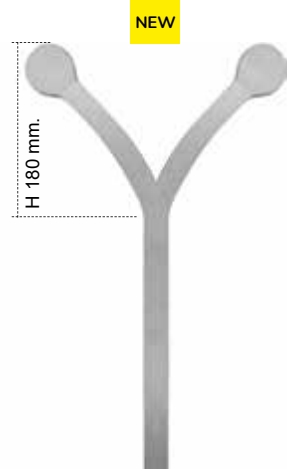

H. 180 X L. 480 mm.
Art. 15.006.15 □ 25 mm

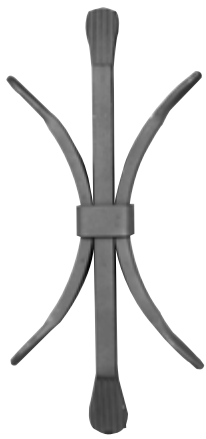

H. 410 X L.195 mm.
Art. 15.007
□ 20 mm. ≙ 20 x 12

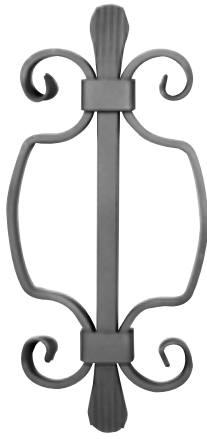

H. 410 X L.195 mm.
Art. 15.008
□ 20 mm. ≙ 20 x 8



H. 410 X L.165 mm.
Art. 15.009
□ 20 mm. ≙ 20 x 10

Foro / Hole Ø14

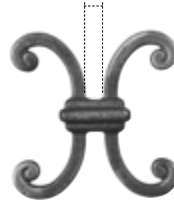

H. 130 X L.130 mm.
Art. 15.009.01
Spessore 12 mm.



Ø 112 mm.
Art. 15.009.02
Spessore 14 mm.



H. 300 mm.
Art. 15.010 □ 25 mm.
Art. 15.011 □ 30 mm.
Art. 15.012 □ 35 mm.
Art. 15.013 □ 40 mm.



H. 350 mm.
Art. 15.013.01 □ 25 mm.
Art. 15.013.02 □ 30 mm.
Art. 15.013.03 □ 35 mm.
Art. 15.013.04 □ 40 mm.



Martellato / Hammered
H. 350 mm.
Art. 15.013.05 □ 25 mm.
Art. 15.013.06 □ 30 mm.
Art. 15.013.07 □ 35 mm.
Art. 15.013.08 □ 40 mm.

Tondo / Round
H. 350 mm.
Art. 15.013.09 Ø 25 mm.
Art. 15.013.10 Ø 30 mm.
Art. 15.013.11 Ø 35 mm.
Art. 15.013.12 Ø 40 mm.

H. 350 mm.
Art. 15.013.13 □ 25 mm.
Art. 15.013.14 □ 30 mm.
Art. 15.013.15 □ 35 mm.
Art. 15.013.51 □ 40 mm.

Martellato / Hammered
H. 350 mm.
Art. 15.013.16 □ 25 mm.
Art. 15.013.17 □ 30 mm.
Art. 15.013.18 □ 35 mm.
Art. 15.013.52 □ 40 mm.

Tondo / Round
H. 350 mm.
Art. 15.013.19 Ø 25 mm.
Art. 15.013.20 Ø 30 mm.

H. 350 mm.
Art. 15.013.21 □ 25 mm.
Art. 15.013.22 □ 30 mm.

Martellato / Hammered
H. 350 mm.
Art. 15.013.23 □ 25 mm.
Art. 15.013.24 □ 30 mm.

Art. 15.013.53 □ 50 mm **NEW**



Tondo / Round
H. 350 mm.
Art. 15.013.25 Ø 25 mm.
Art. 15.013.26 Ø 30 mm.

H. 350 mm.
Art. 15.013.27 □ 25 mm.
Art. 15.013.28 □ 30 mm.
Art. 15.013.29 □ 35 mm.
Art. 15.013.30 □ 40 mm.

Martellato / Hammered
H. 350 mm.
Art. 15.013.31 □ 25 mm.
Art. 15.013.32 □ 30 mm.
Art. 15.013.33 □ 35 mm.
Art. 15.013.34 □ 40 mm.

H. 350 mm.
Art. 15.013.35 □ 25 mm.
Art. 15.013.36 □ 30 mm.
Art. 15.013.37 □ 35 mm.
Art. 15.013.38 □ 40 mm.

Martellato / Hammered
H. 350 mm.
Art. 15.013.39 □ 25 mm.
Art. 15.013.40 □ 30 mm.
Art. 15.013.41 □ 35 mm.
Art. 15.013.42 □ 40 mm.

H. 360 mm.
Art. 15.013.45 □ 25 mm.
Art. 15.013.46 □ 30 mm.
Art. 15.013.47 □ 35 mm.

Martellato / Hammered
H. 360 mm.
Art. 15.013.48 □ 25 mm.
Art. 15.013.49 □ 30 mm.
Art. 15.013.50 □ 35 mm.



Martellato / *Hammered*
H. 350 mm
Art. 15.013.60 □ 25 mm
Art. 15.013.61 □ 30 mm

Liscio / *Smooth*
H. 350 mm
Art. 15.013.62 □ 25 mm
Art. 15.013.63 □ 30 mm
Art. 15.013.64 Ø 25 mm
Art. 15.013.65 Ø 30 mm

Martellato / *Hammered*
H. 300 mm.
Art. 15.014 □ 25 mm.
Art. 15.015 □ 30 mm.

Mod. Scala / *Scala Model*
H. 350 mm.
Art. 15.015.01 □ 25 mm.
Art. 15.015.02 □ 30 mm.

H. 350 mm.
Art. 15.015.03 □ 25 mm.
Art. 15.015.04 □ 30 mm.

Martellato / *Hammered*
H. 350 mm.
Art. 15.015.05 □ 25 mm.
Art. 15.015.06 □ 30 mm.

Tondo / *Round*
H. 350 mm.
Art. 15.015.07 Ø 25 mm.
Art. 15.015.08 Ø 30 mm.



Tondo Lavorato
Worked Round Bar
H. 350 mm.
Art. 15.015.09 Ø 25 mm.
Art. 15.015.10 Ø 30 mm.

Martellato / *Hammered*
H. 300 mm
Art. 15.016 □ 25 mm
Art. 15.017 □ 30 mm
Art. 15.017.02 □ 35 mm
Art. 15.017.03 □ 25 mm Liscio/Smooth
Art. 15.017.04 □ 30 mm Liscio/Smooth
Art. 15.017.05 □ 35 mm Liscio/Smooth
Art. 15.017.06 □ 40 mm Liscio/Smooth
Art. 15.017.14 □ 50 mm Liscio/Smooth **NEW**

Mod. Scala / *Scala Model*
H. 350 mm.
Art. 15.017.07 □ 25 mm.
Art. 15.017.08 □ 30 mm.
Art. 15.017.09 □ 35 mm.

H. 350 mm.
Art. 15.017.10
≠ 30 x 20

Martellato / *Hammered*
H. 350 mm.
Art. 15.017.11
≠ 30 x 20

Martellato / *Hammered*
H. 350 mm.
Art. 15.017.12 □ 25 mm.
Liscio / *Smooth*
H. 350 mm.
Art. 15.017.13 □ 25 mm.



Tutte le parti di questo catalogo - foto comprese - sono di proprietà Euro-Fer. La riproduzione, anche parziale, è vietata in ogni forma e con ogni mezzo. / Every part of this catalogue - photos included - is Euro-Fer's property. All forms of copying are strictly prohibited.

**CIMASE, TERMINALI ED ELEMENTI VARI
ORNAMENTS FOR CARRIAGE GATES AND VARIOUS ELEMENTS**



H. 300 mm.
Art. 15.018
≠ 70 X 6 mm.
Art. 15.018.50
≠ 50 X 6 mm.
Art. 15.018.51
≠ 60 X 6 mm.
Art. 15.018.52
≠ 80 X 6 mm.



Mod. Scala / Scala Model
H. 350 mm.
Art. 15.018.01
≠ 60 X 8 mm.



H. 350 mm.
Art. 15.018.02
≠ 40 X 6 mm.
Art. 15.018.03
≠ 50 X 6 mm.



H. 300 mm.
Art. 15.018.04
≠ 40 X 6 mm.
Art. 15.018.05
≠ 50 X 6 mm.
Art. 15.018.06
≠ 60 X 6 mm.



H. 350 mm.
Art. 15.018.07
≠ 50 X 8 mm.



Martellato / Hammered
H. 350 mm.
Art. 15.018.08
≠ 50 X 8 mm.



H. 350 mm.
Art. 15.018.09
≠ 50 X 10 mm.



Mod. Scala / Scala Model
H. 350 mm.
Art. 15.018.10
≠ 60 X 8 mm.



Battuto / Beaten
H. 350 mm.
Art. 15.018.11
≠ 60 X 8 mm.



H.300 mm.
Art. 15.019
≠ 70x6 mm

H.300 mm.
Art. 15.019.40 NEW
≠ 40x10 mm

Ribattini Martellati
Hammered-Head Rivets



H. 30 mm. - Ø 10 mm.
Art. 15.019.01
Testa / Head Ø 20



H. 30 mm. - Ø 10 mm.
Art. 15.019.02
Testa / Head Ø 24



Fuori Produzione
Out of Production

Art. 15.019.03



H. 60 X L.100 mm.
Art. 15.021.03
Spessore 35 mm.



H. 60 X L.60 mm.
Art. 15.021.04
Spessore 40 mm.



H. 35 mm.- Ø 100 mm
Art. 15.021.08
Spessore 12 mm.



L.105 mm
≠ 40 x 8 mm
Art. 15.021.50
foro/hole ø 35 x 17 mm

Chiodi di Ferro
Iron Nails



Art. 15.019.23 H. 230 □ 10 mm.
Art. 15.019.27 H. 270 □ 10 mm.
Art. 15.019.30 H. 300 □ 10 mm.



Spessore 10 mm.
Art. 15.021
□ Foro 32 mm.

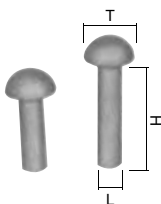

Art.15.022 L.6 X H.20 T. 11/12 mm.
Art.15.023 L.6 X H.25 T. 11/12 mm.
Art.15.024 L.6 X H.30 T. 11/12 mm.
Art.15.025 L.6 X H.35 T. 11/12 mm.
Art.15.026 L.6 X H.40 T. 11/12 mm.
Art.15.027 L.6 X H.45 T. 11/12 mm.
Art.15.028 L.6 X H.50 T. 11/12 mm.

Art.15.029 L.8 X H.20 T. 13/14 mm.
Art.15.030 L.8 X H.25 T. 13/14 mm.
Art.15.031 L.8 X H.30 T. 13/14 mm.
Art.15.032 L.8 X H.35 T. 13/14 mm.
Art.15.033 L.8 X H.40 T. 13/14 mm.
Art.15.034 L.8 X H.45 T. 13/14 mm.
Art.15.035 L.8 X H.50 T. 13/14 mm.

Art.15.036 L.10 X H.25 T. 17 mm.
Art.15.037 L.10 X H.30 T. 17 mm.
Art.15.038 L.10 X H.35 T. 17 mm.
Art.15.039 L.10 X H.40 T. 17 mm.
Art.15.040 L.10 X H.45 T. 17 mm.
Art.15.041 L.10 X H.50 T. 17 mm.

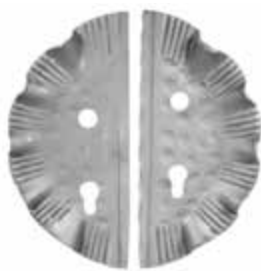
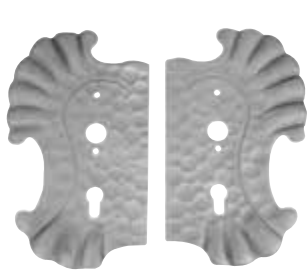

H. 275 X L.160 mm.

H. 275 X L.160 mm.

H. 260 X L.115 mm.

H. 260 X L.115 mm.

H. 295 X L.130 mm.

H. 295 X L.130 mm.

H. 230 X L.80 mm.

H. 300 X L.105 mm.

Art. 15.042
Spessore 3 mm.
Art. 15.042.01
Senza Foro
Without Hole

Art. 15.043
Spessore 3 mm.
Art. 15.043.01
Senza Foro
Without Hole

Art. 15.044
Spessore 3 mm.
Art. 15.044.01
Senza Foro
Without Hole

Art. 15.045.01
Senza Foro
Without Hole

Art. 15.046
Spessore 3 mm.
Art. 15.046.01
Senza Foro
Without Hole

Art. 15.047.01
Senza Foro
Without Hole

Art. 15.048
Spessore 6 mm.

Art. 15.049
Spessore 6 mm.

SUPPORTI PER MENSOLE
SUPPORTS FOR SHELVES
colore nero / black colour



H.200 x L.90 mm
Art. 15.049.10
≠ 3 mm

H. 200 X L.160 mm.
Art. 15.050
≠ 20 X 4

H. 155 X L.125 mm.
Art. 15.050.01

H. 225 X L.175 mm.
Art. 15.050.02

H. 280 X L.220 mm.
Art. 15.050.03

Copricolonna saldati e molati
Post caps welded and grinded

Copricolonna puntati in lamierino
Post caps in iron sheet

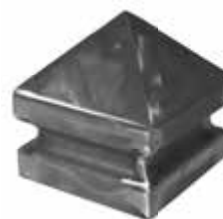

Art. 15.059.001 H. 40 x 40 mm
Art. 15.059.002 H. 50 x 50 mm
Art. 15.059.003 H. 60 x 60 mm
Art. 15.059.004 H. 70 x 70 mm
Art. 15.059.005 H. 80 x 80 mm
Art. 15.059.006 H. 100 x 100 mm
Art. 15.059.007 H. 120 x 120 mm
Art. 15.059.008 H. 150 x 150 mm

Art. 15.059.02 H.150 X L.150
Art. 15.059.03 H.120 X L.120
Art. 15.059.04 H.100 X L.100

Copricolonna
Post Caps

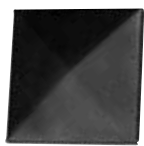

Art. 15.052 □ 30 X 30
Art. 15.053 □ 40 X 40
Art. 15.054 □ 50 X 50
Art. 15.055 □ 60 X 60
Art. 15.056 □ 80 X 80
Art. 15.057 □ 100 X 100
Art. 15.058 □ 120 X 120
Art. 15.059 □ 150 X 150

Si raccomanda di zincare a caldo le sfere vuote in lamiera solo dopo averle forate
It's recommended to perforate the Hollow Spheres before the hot galvanization



Light mod. T wheel-round groove

Art. 15.062 80 X 20 mm.
Art. 15.063 100 X 20 mm.
Art. 15.065 140 X 20 mm.

Ruota leggera mod. T a "V"
Light mod. T wheel-"V" shaped

Art. 15.072 60 X 20 mm.
Art. 15.075 100 X 20 mm.
Art. 15.076 120 X 20 mm.
Art. 15.077 140 X 20 mm.

Heavy mod. T wheel-round groove

Art. 15.069 140 x 30 mm
Art. 15.070 160 x 30 mm

Ruota pesante mod. T a "V"
con doppio cuscinetto
Heavy mod. T wheel-"V" shaped
double bearing

Art. 15.079 100 X 30 mm.
Art. 15.080 120 X 30 mm.
Art. 15.081 140 X 30 mm.

Ruota con piastra a saldare gola tonda mod. T
Mod. "T" wheel with plate to weld-round groove

Art. 15.086 120 X 30 mm.



Ruota con piastra a saldare a "V" mod. T
Mod. T wheel with plate to weld-"V" shaped

Art. 15.091 140 X 30 mm.

Ruota a supporto interno mod. T gola tonda
Mod. T wheel with internal support-round groove

Art. 15.092 120 X 20 mm.
Art. 15.093 140 X 20 mm.
Art. 15.094 120 X 30 mm.
Art. 15.095 140 X 30 mm.



**CIMASE, TERMINALI ED ELEMENTI VARI
ORNAMENTS FOR CARRIAGE GATES AND VARIOUS ELEMENTS**



Cardine a barra lunga
Long bar hinge
Zincato / Zinc-Plated
Art. 15.102 Ø 18 MA
Art. 15.103 Ø 22 MA



Cardine a muro
Hinge wall
Zincato / Zinc-Plated
Art. 15.107 Ø 18 MA
Art. 15.108 Ø 22 MA
Art. 15.109 Ø 27 MA



Cardine a saldare
Hinge -Welding hinge
Zincato / Zinc-Plated
Art. 15.113 Ø 18 MA
Art. 15.114 Ø 22 MA
Art. 15.115 Ø 27 MA



Cardine a regolazione ortogonale (con vite a perno zincati)
Right-angle adjustment hinge (whit galvanized screw and pin)
Art. 15.116 Ø 18 MA
Art. 15.117 Ø 22 MA
Art. 15.118 Ø 27 MA



Zincato / Zinc-Plated
Art. 15.122 H.15 X L.60 mm.
Art. 15.123 H.20 X L.70 mm.
Art. 15.124 H.20 X L.80 mm.



Zincato / Zinc-Plated
Art. 15.128 H. 89 mm. Ø 20 mm.
Art. 15.129 H. 98 mm. Ø 23mm.
Art. 15.130 H.105 mm. Ø 28 mm.



Zincato / Zinc-Plated
Art. 15.131 Cardine 18 MA per □30 - piastra 90 X 90 X 4
Art. 15.132 Cardine 22 MA per □35 - piastra 110 X 110 X 5
Art. 15.133 Cardine 27 MA per □40 - piastra 130 X 130 X 5



Zincato / Zinc-Plated
Art. 15.134 Cardine 18 MA regolabile per □30 - piastra 90 X 90 X 4
Art. 15.135 Cardine 22 MA regolabile per □35 - piastra 110 X 110 X 5
Art. 15.136 Cardine 27 MA regolabile per □40 - piastra 130 X 130 X 5



Zincato / Zinc-Plated
Art. 15.137 Cardine 18 MA regolabile per □30
Art. 15.138 Cardine 22 MA regolabile per □35
Art. 15.139 Cardine 27 MA regolabile per □40

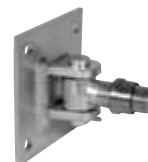

Zincato / Zinc-Plated
Art. 15.140 Cardine 18 MA con orecchie saldate su piastra 90 X 90 X 4
Art. 15.141 Cardine 22 MA con orecchie saldate su piastra 110 X 110 X 5
Art. 15.142 Cardine 27 MA con orecchie saldate su piastra 130 X 130 X 5

Accessori per cancelli in ferro battuto /
Perni di collegamento e guida superiore
Connection pins and upper guide

Accessories for wrought iron gates
Perni di collegamento e guida inferiore
Connection pins and lower guide



Art. 15.143
Perno sup. per cardine
Ø 24 per tub. □30X 3

Art. 15.144
Perno sup. per cardine
Ø 29 per tub. □35X 3

Art. 15.145
Perno sup. per cardine
Ø 34 per tub. □40X 3



Art. 15.146
Perno sup. per cardine
Ø 30 per ■30X 3

Art. 15.147
Perno sup. per cardine
Ø 35 per ■35X 3

Art. 15.148
Perno sup. per cardine
Ø 40 per ■40X 3



Art. 15.149
Perno inf. per cardine
Ø 19 A

Art. 15.150
Perno inf. per cardine
Ø 22A

Art. 15.151
Perno inf. per cardine
Ø 27A

Cerniere con cuscinetti a sfere
Hinge with ball bearings

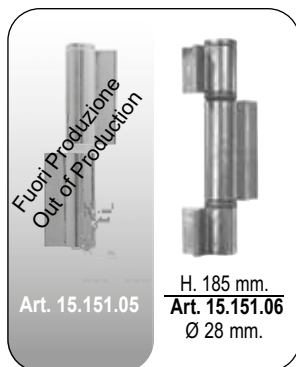

H. 80 mm.
Art. 15.151.01
Ø 12 mm.
H. 140 mm.
Art. 15.151.02
Ø 16,5 mm.



H. 100 mm.
Art. 15.151.03
Ø 13,5 mm.
H. 140 mm.
Art. 15.151.04
Ø 16,5 mm.



H. 185 mm.
Art. 15.151.05
Ø 28 mm.



H. 100 mm.
Art. 15.151.07
Ø 20 mm.



H. 120 mm.
Art. 15.151.08
Ø 24 mm.



H. 145 mm.
Art. 15.151.09
Ø 30 mm.



H. 200 mm.
Art. 15.151.10
Ø 30 mm.

Tutti i Fori sono Ø 11 / All Holes Ø 11

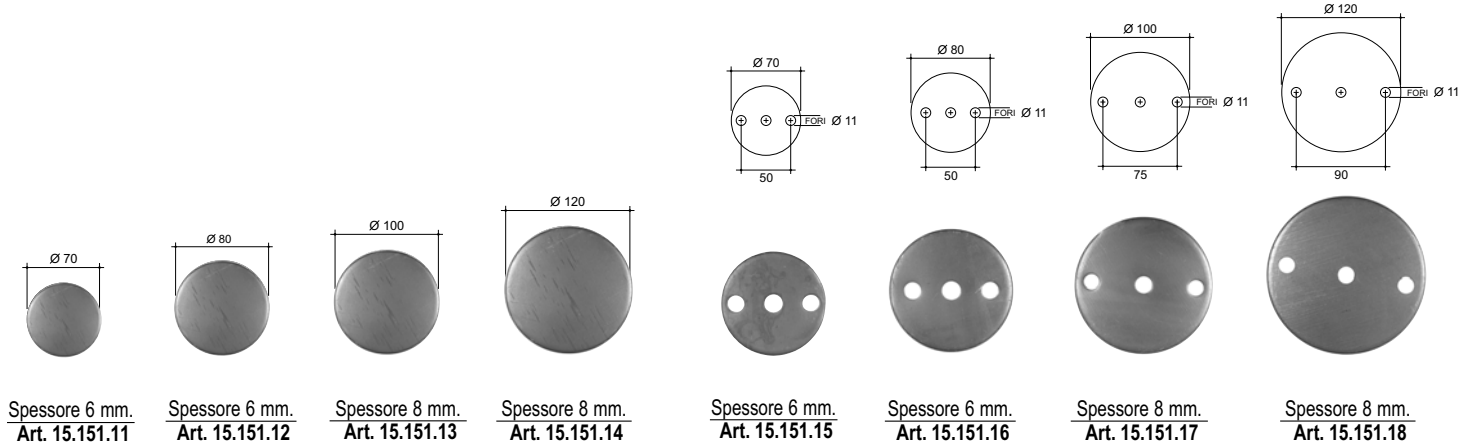

Tutti i Fori sono Ø 11 / All Holes Ø 11

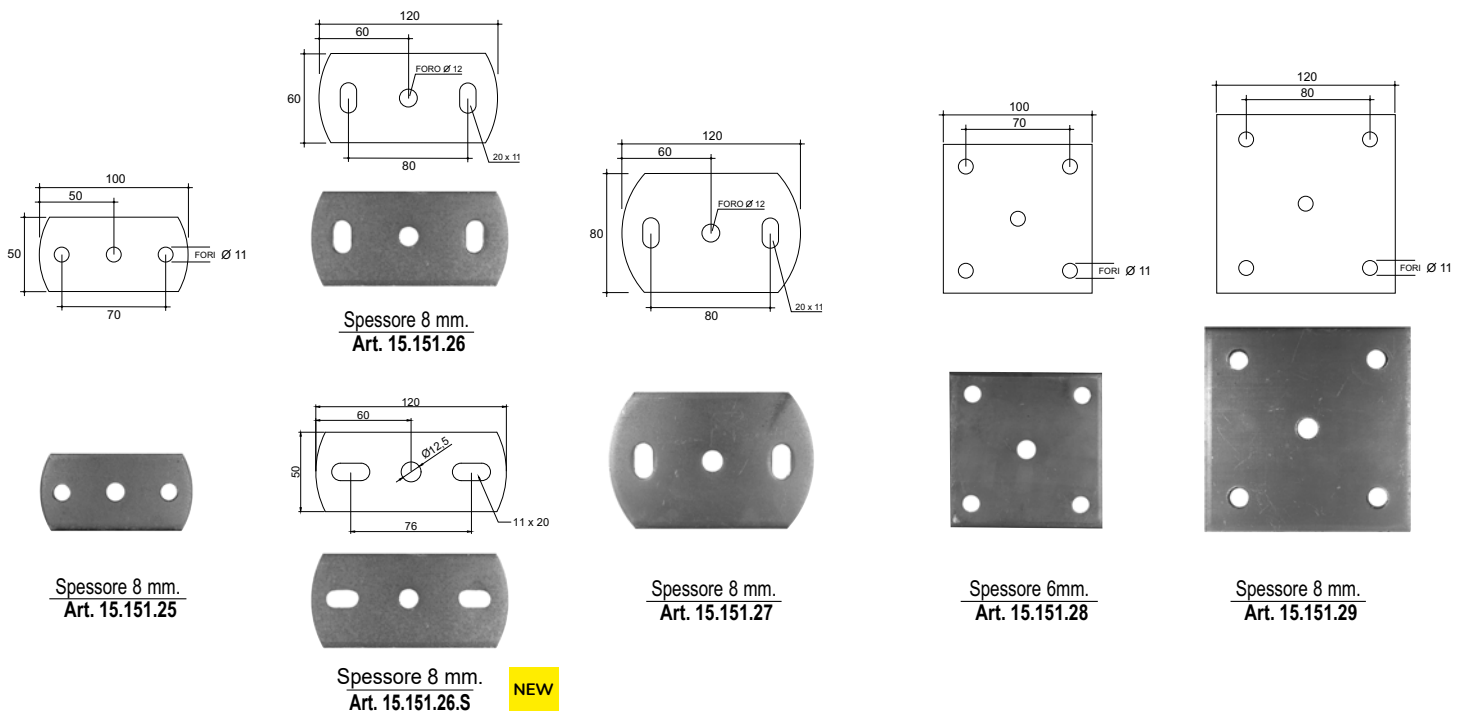
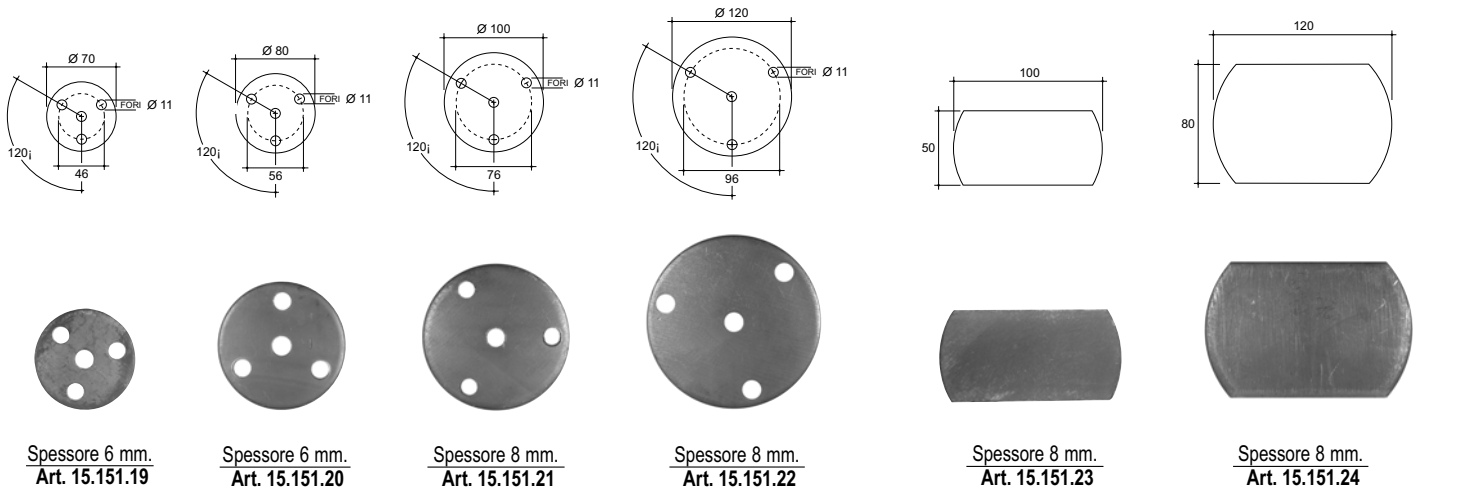

Tutte le parti di questo catalogo - foto comprese - sono di proprietà Euro-Fer. La riproduzione, anche parziale, è vietata in ogni forma e con ogni mezzo. / Every part of this catalogue - photos included - is Euro-Fer's property. All forms of copying are strictly prohibited.

NEW **Guide per cancelli scorrevoli** **NEW**
Guides for sliding gates

Guida SISTEMA

Guide SISTEMA



Esempio / Example

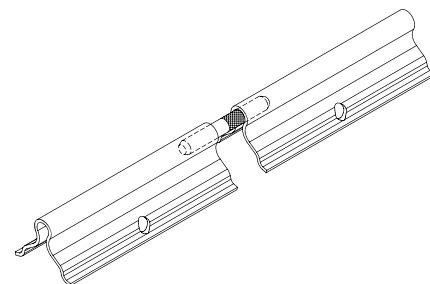
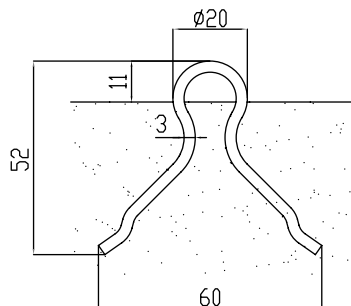

Articolo Article	Descrizione Description
GUIDA.SISTEMA	Zincata da 6000 mm con spessore 3 mm Portata max cancello 700 kg - Peso barra 9,3 kg Guide 6000 mm galvanized with 3 mm thickness Max gate capacity 700 kg - Bar weight 9.3 kg
GUIDA.GIUNZIONE.53	Spina giunzione Omega Ø 13x100 mm tropicalizzata Omega junction plug Ø 13x100 mm tropicalized

Guida IBBI

Guide IBBI



Esempio / Example

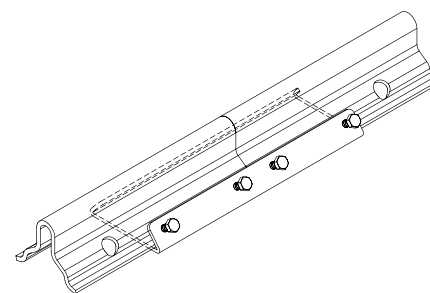
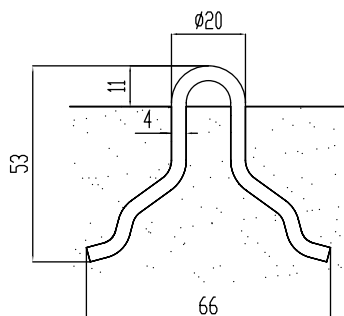

Articolo Article	Descrizione Description
GUIDA.IBBI	Zincata da 6000 mm con spessore 4 mm Portata max cancello 700 kg - peso barra 17,22 kg Guide 6000 mm galvanized with 4 mm thickness Max gate capacity 700 kg - Bar weight 17,22 kg
GUIDA. GIUNZIONE.RP	Giunzione 77 x 22 x 225 mm spessore 3 mm con viti tropicalizzata Junction 77 x 22 x 225 mm 3 mm thick with tropicalized screws

Guida FLOOR

Guide FLOOR

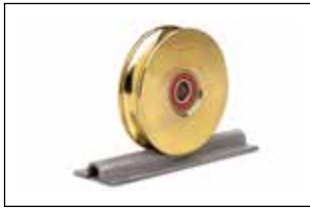

Esempio / Example

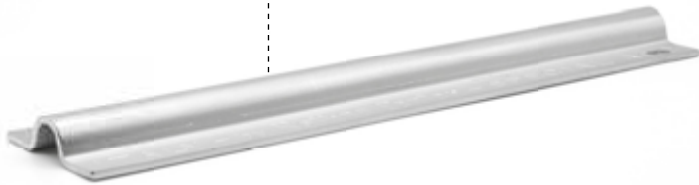
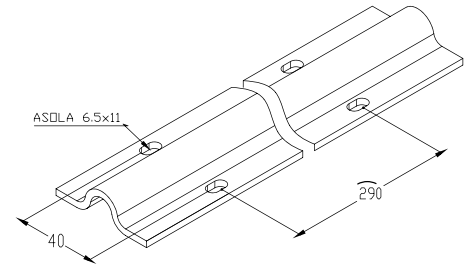
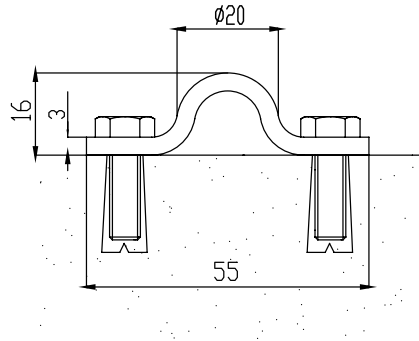

La guida pronta all'uso - The ready-to-use guide

Articolo Article	Descrizione Description
GUIDA.FLOOR	Zincata da 6000 mm con spessore 3,5 mm Portata max cancello 500 kg - Peso barra 22,5 kg Guide 6000 mm galvanized with 3,5 mm thickness Max gate capacity 500 kg - Bar weight 22,50 kg

Tubolari forati adattabili NEW a varie tipologie di serratura.

*Perforated tubulars adaptable
to various types of locks.*

Eurofer può realizzare con cura e precisione pratici tubolari forati di varia sezione e forma, compatibili con varie tipologie di serratura. Tutto ciò si può realizzare sia per tubolari di ferro ma anche di acciaio inossidabile.

Eurofer can carefully and precisely create practical perforated tubes of various sections and shapes, compatible with various types of locks. All this can be achieved both for iron tubing and also for stainless steel.

**Sia su ferro
che su inox
in sezione tonda
o quadra**

*On iron and stainless steel
in round or square section*



Articoli forniti in coppia / These pieces are furnished in pair

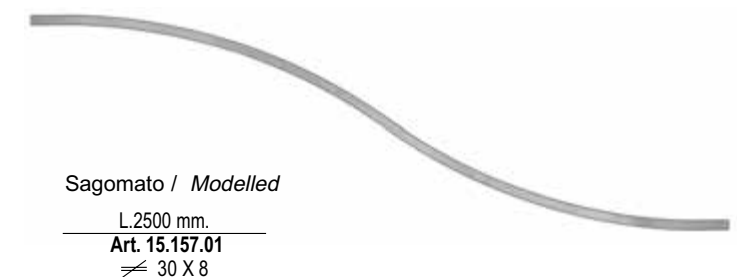
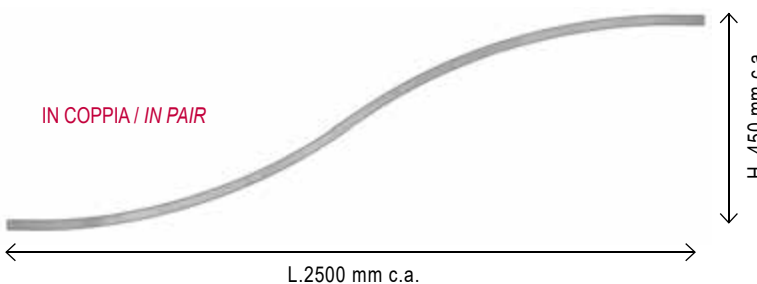
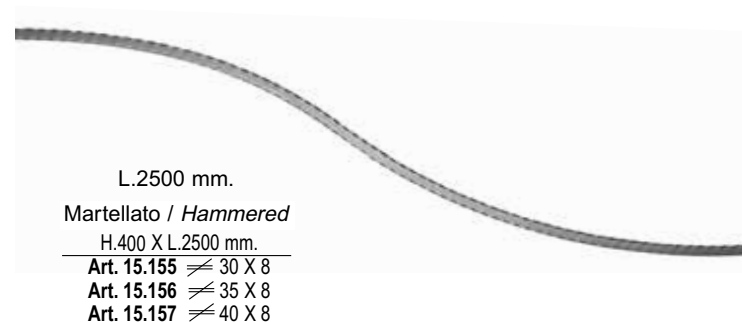
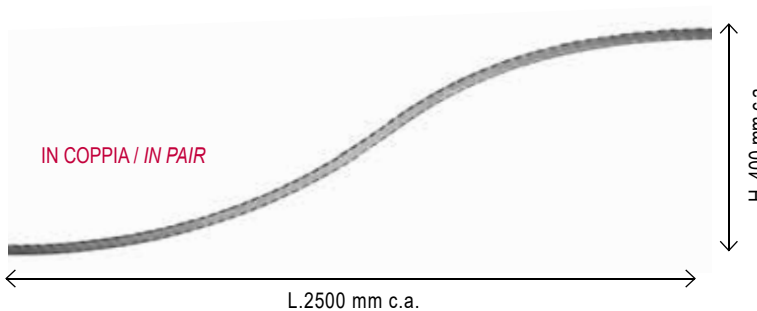
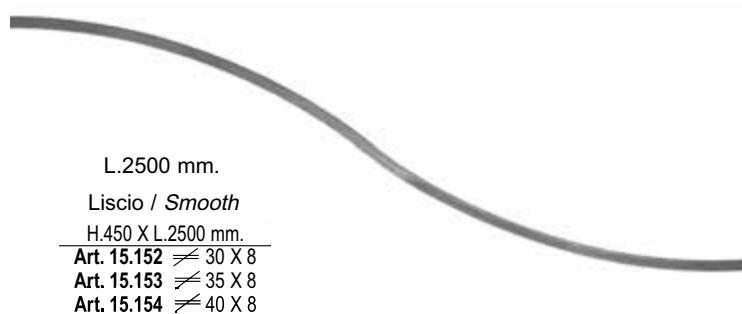
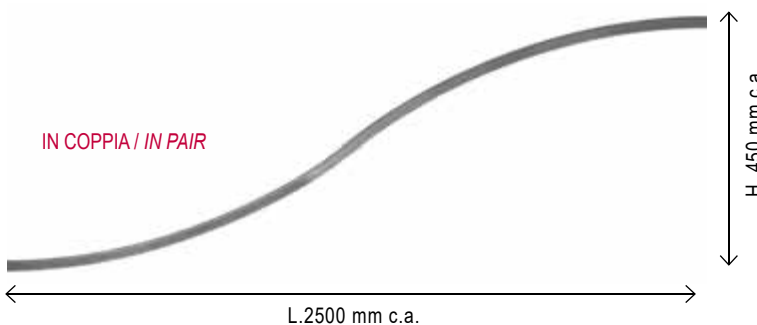
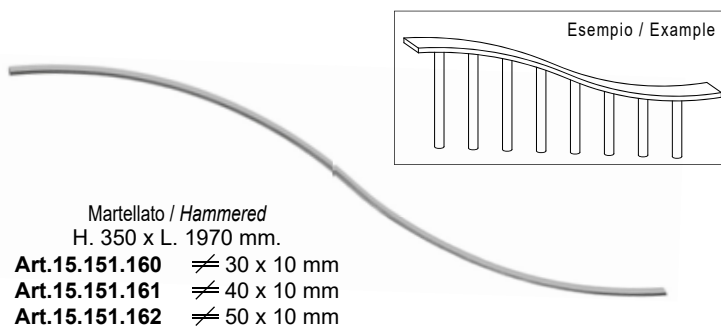
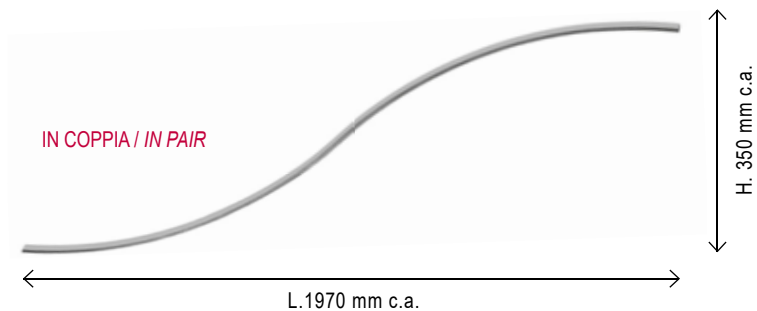
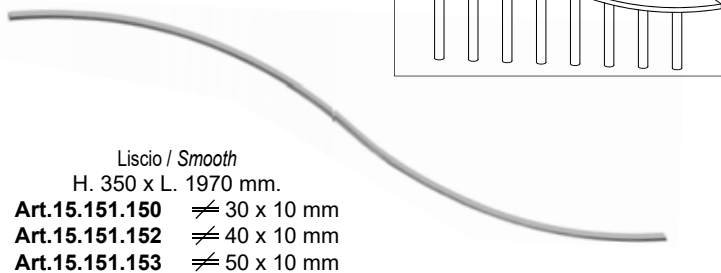
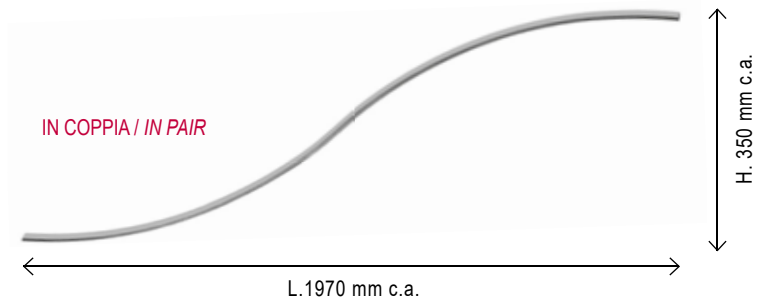

Articoli forniti in coppia / These pieces are furnished in pair

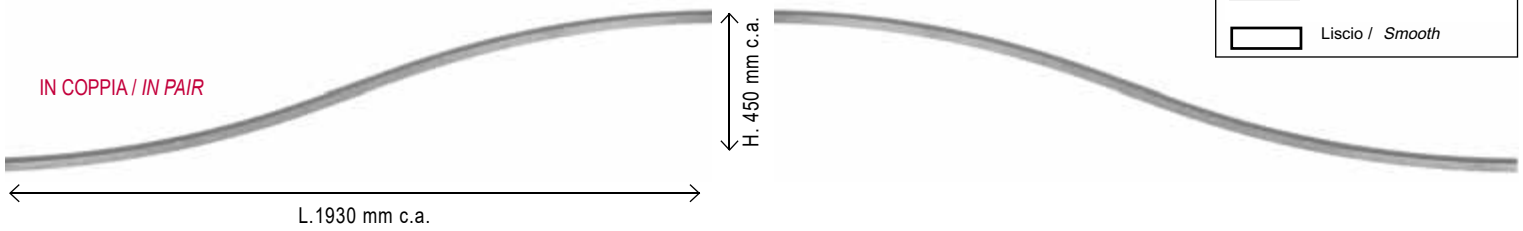
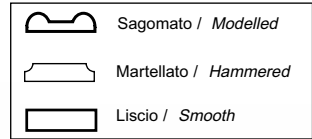

Tubolare Martellato / Hammered Bars

L.1930 mm. H. 450 mm.

Art. 15.157.04	30 X 30 X 2,5
Art. 15.157.05	40 X 20 X 2,5

Tubolare Liscio / Smooth Bars

L.1930 mm. H. 450 mm.

Art. 15.157.02	30 X 30 X 2,5
Art. 15.157.03	40 X 20 X 3

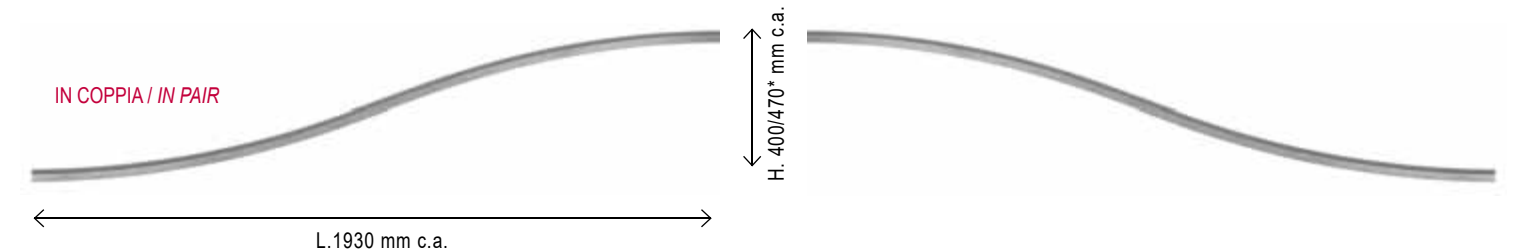

Martellato / Hammered

L.1930 mm. H. 400 mm.

Art. 15.157.06	30 X 8
Art. 15.157.08	35 X 8
Art. 15.157.10	40 X 8

Sagomato / Modelled

L.1930 mm. H. 470 mm.

Art. 15.157.12	30 X 8
----------------	--------

Liscio / Smooth

L.1930 mm. H. 470 mm.

Art. 15.157.14	30 X 8
Art. 15.157.15	35 X 8
Art. 15.157.16	40 X 8

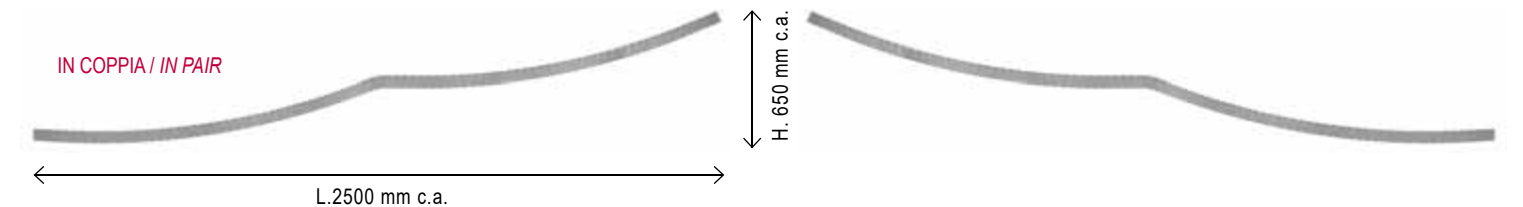

Martellato / Hammered

L.2500 mm.

Art. 15.157.17	30 X 8
Art. 15.157.18	35 X 8
Art. 15.157.19	40 X 8

Sagomato / Modelled

L.2500 mm.

Art. 15.157.20	30 X 8
----------------	--------

Liscio / Smooth

L.2500 mm.

Art. 15.157.21	30 X 8
Art. 15.157.22	35 X 8
Art. 15.157.23	40 X 8

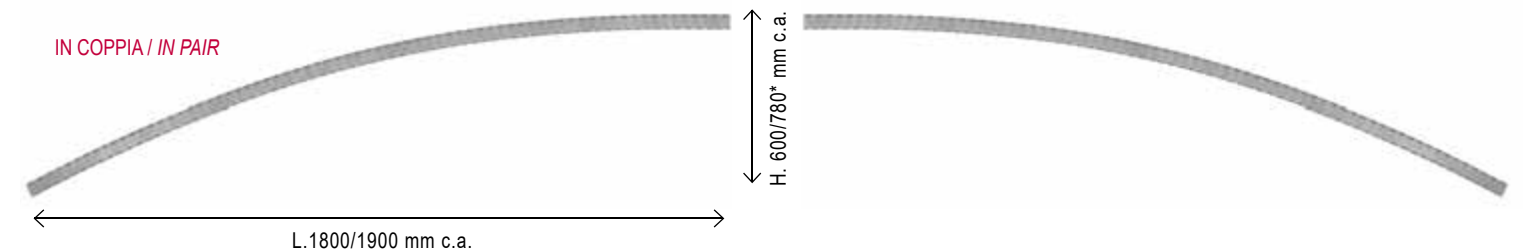

Martellato / Hammered

L. 1900 mm. H. 600 mm.

Art. 15.157.24	30 X 8
Art. 15.157.25	35 X 8
Art. 15.157.26	40 X 8

Mod. Scala / Scala Model

L. 1800 mm. H. 780 mm. *

Art.15.157.27	30 x 8 mm
Art.15.157.28	35 x 8 mm
Art.15.157.29	40 x 8 mm

Liscio / Smooth

L.1800 mm. H. 780 mm.

Art. 15.157.30	30 X 8
Art. 15.157.31	35 X 8
Art. 15.157.32	40 X 8

Fuori Produzione
Out of Production

**CIMASE, TERMINALI ED ELEMENTI VARI
ORNAMENTS FOR CARRIAGE GATES AND VARIOUS ELEMENTS**

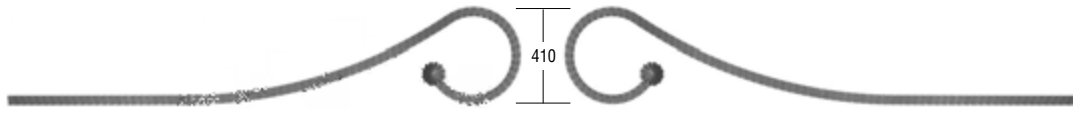

Sinistro / *Left*
Martellato / *Hammered*
L.2150 mm.
Art. 15.157.33 ≙ 30 X 8
Art. 15.157.35 ≙ 35 X 8
Art. 15.157.37 ≙ 40 X 8

Sinistro / *Left*
Liscio / *Smooth*
L.2150 mm.
Art. 15.157.39 ≙ 30 X 8
Art. 15.157.41 ≙ 35 X 8
Art. 15.157.43 ≙ 40 X 8

Destro / *Right*
Martellato / *Hammered*
L.2150 mm.
Art. 15.157.34 ≙ 30 X 8
Art. 15.157.36 ≙ 35 X 8
Art. 15.157.38 ≙ 40 X 8

Destro / *Right*
Liscio / *Smooth*
L.2150 mm.
Art. 15.157.40 ≙ 30 X 8
Art. 15.157.42 ≙ 35 X 8
Art. 15.157.44 ≙ 40 X 8



Sinistro / *Left*
Martellato / *Hammered*
L.2000 mm.
Art. 15.157.45 ≙ 30 X 8
Art. 15.157.47 ≙ 35 X 8
Art. 15.157.49 ≙ 40 X 8

Liscio / *Smooth*
L.2000 mm.
Art. 15.157.51 ≙ 30 X 8
Art. 15.157.52 ≙ 35 X 8
Art. 15.157.53 ≙ 40 X 8

Destro / *Right*
Martellato / *Hammered*
L.2000 mm.
Art. 15.157.46 ≙ 30 X 8
Art. 15.157.48 ≙ 35 X 8
Art. 15.157.50 ≙ 40 X 8

N.B.: Nel piatto liscio
sinistro o destro sono uguali.
Note: Right and left sides are equal in
smooth flat sections.

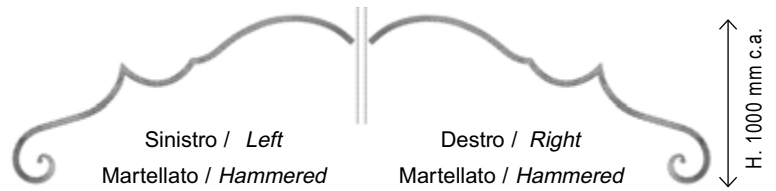

Sinistro / *Left*
Martellato / *Hammered*
L.2000 mm.
Art. 15.157.54 ≙ 35 X 8
Art. 15.157.56 ≙ 40 X 8

Liscio / *Smooth*
L.2000 mm.
Art. 15.157.58 ≙ 35 X 8
Art. 15.157.59 ≙ 40 X 8

Destro / *Right*
Martellato / *Hammered*
L.2000 mm.
Art. 15.157.55 ≙ 35 X 8
Art. 15.157.57 ≙ 40 X 8

N.B.: Nel piatto liscio
sinistro o destro sono uguali.
Note: Right and left sides are equal in
smooth flat sections.



CIMASE, TERMINALI ED ELEMENTI VARI ORNAMENTS FOR CARRIAGE GATES AND VARIOUS ELEMENTS

N.B.: Nel piatto liscio
sinistro o destro sono uguali.
Note: Right and left sides are equal in
smooth flat sections.

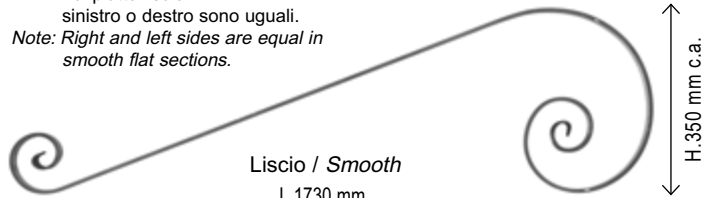

Liscio / Smooth
L.1730 mm.
Art. 15.157.60 ≙ 30 X 8
Art. 15.157.61 ≙ 35 X 10
Art. 15.157.62 ≙ 40 X 8

H.350 mm c.a.

N.B.: Nel piatto liscio
sinistro o destro sono uguali.
Note: Right and left sides are equal in
smooth flat sections.

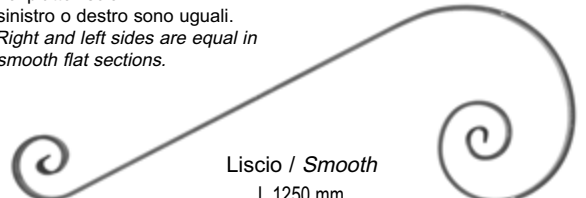

Liscio / Smooth
L.1250 mm.
Art. 15.157.63 ≙ 30 X 8
Art. 15.157.64 ≙ 35 X 10
Art. 15.157.65 ≙ 40 X 8

H.350 mm c.a.

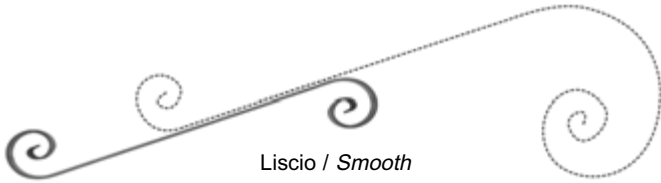

Liscio / Smooth
L.1150 mm.
Art. 15.157.66 ≙ 30 X 8
Art. 15.157.67 ≙ 35 X 10
Art. 15.157.68 ≙ 40 X 8

N.B.: Nel piatto liscio
sinistro o destro sono uguali.
Note: Right and left sides are equal in
smooth flat sections.

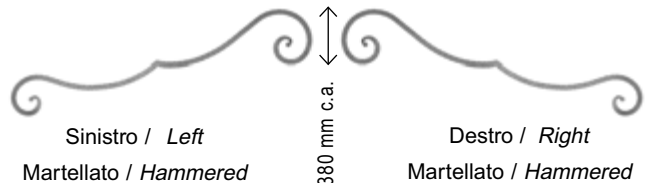

Sinistro / Left
Martellato / Hammered
L.2100 mm.
Art. 15.157.69 ≙ 35 X 8
Art. 15.157.71 ≙ 40 X 8

Destro / Right
Martellato / Hammered
L.2100 mm.
Art. 15.157.70 ≙ 35 X 8
Art. 15.157.72 ≙ 40 X 8

H.380 mm c.a.

H.850 mm c.a.

Liscio / Smooth
L.2100 mm.
Art. 15.157.73 ≙ 35 X 8
Art. 15.157.74 ≙ 40 X 8

N.B.: Nel piatto liscio
sinistro o destro sono uguali.
Note: Right and left sides are equal in
smooth flat sections.



Sinistro / Left
Martellato / Hammered
L.2000 mm.
Art. 15.157.75 ≙ 35 X 8
Art. 15.157.77 ≙ 40 X 8

Destro / Right
Martellato / Hammered
L.2000 mm.
Art. 15.157.76 ≙ 35 X 8
Art. 15.157.78 ≙ 40 X 8

Liscio / Smooth
L.2000 mm.
Art. 15.157.79 ≙ 35 X 8
Art. 15.157.80 ≙ 40 X 8

N.B.: Nel piatto liscio
sinistro o destro sono uguali.
Note: Right and left sides are equal in
smooth flat sections.

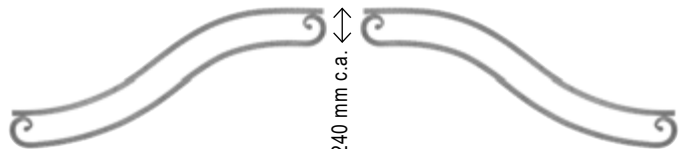

Sinistro / Left
Martellato / Hammered
L.2000 mm.
Art. 15.157.81 ≙ 35 X 8
Art. 15.157.83 ≙ 40 X 8

Destro / Right
Martellato / Hammered
L.2000 mm.
Art. 15.157.82 ≙ 35 X 8
Art. 15.157.84 ≙ 40 X 8

H.240 mm c.a.

H.800 mm c.a.

Liscio / Smooth
L.2000 mm.
Art. 15.157.85 ≙ 35 X 8
Art. 15.157.86 ≙ 40 X 8

N.B.: Nel piatto liscio
sinistro o destro sono uguali.
Note: Right and left sides are equal in
smooth flat sections.



Sinistro / Left
Martellato / Hammered
L.1900 mm.
Art. 15.157.87 ≙ 35 X 8
Art. 15.157.89 ≙ 40 X 8

Destro / Right
Martellato / Hammered
L.1900 mm.
Art. 15.157.88 ≙ 35 X 8
Art. 15.157.90 ≙ 40 X 8

Liscio / Smooth
L.1900 mm.
Art. 15.157.91 ≙ 35 X 8
Art. 15.157.92 ≙ 40 X 8

N.B.: Nel piatto liscio
sinistro o destro sono uguali.
Note: Right and left sides are equal in
smooth flat sections.

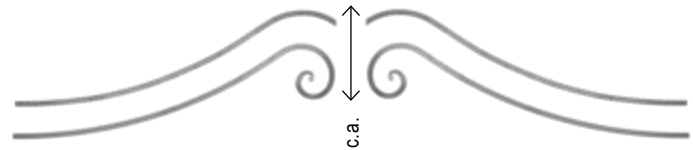

Sinistro / Left
Martellato / Hammered
L.2100 mm.
Art. 15.157.93 ≙ 35 X 8
Art. 15.157.95 ≙ 40 X 8

Destro / Right
Martellato / Hammered
L.2100 mm.
Art. 15.157.94 ≙ 35 X 8
Art. 15.157.96 ≙ 40 X 8

H.600 mm c.a.

H.900 mm c.a.

Liscio / Smooth
L.2100 mm.
Art. 15.157.97 ≙ 35 X 8
Art. 15.157.98 ≙ 40 X 8

N.B.: Nel piatto liscio
sinistro o destro sono uguali.
Note: Right and left sides are equal in
smooth flat sections.

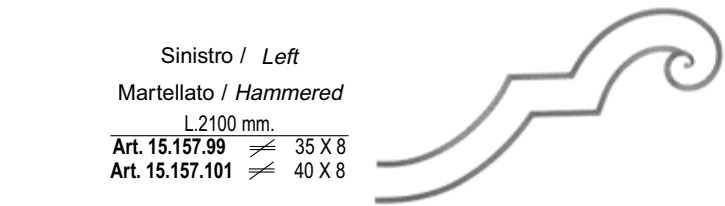

Sinistro / Left
Martellato / Hammered
L.2100 mm.
Art. 15.157.99 ≙ 35 X 8
Art. 15.157.101 ≙ 40 X 8

Liscio / Smooth
L.2100 mm.
Art. 15.157.103 ≙ 35 X 8
Art. 15.157.104 ≙ 40 X 8

H.550 mm c.a.

Destro / Right
Martellato / Hammered
L.2100 mm.
Art. 15.157.100 ≙ 35 X 8
Art. 15.157.102 ≙ 40 X 8

N.B.: Nel piatto liscio
sinistro o destro sono uguali.
Note: Right and left sides are equal in
smooth flat sections.

H.1150 mm c.a.

Pezzi forniti singolarmente / These pieces are furnished separately

CIMASE E CANCELLI PEDONALI



Liscio / Smooth

H.150 X L.1500 mm.

Art. 15.157.105 ≙ 30 X 8
Art. 15.157.106 ≙ 35 X 8
Art. 15.157.107 ≙ 40 X 8

Martellato / Hammered

H.150 X L.1500 mm.

Art. 15.157.108 ≙ 30 X 8
Art. 15.157.109 ≙ 35 X 8
Art. 15.157.110 ≙ 40 X 8



Tubolare Liscio
Smooth Bars

H.150 X L.1450 mm.

Art. 15.157.114 □ 30 X 30
Art. 15.157.115 □ 40 X 20

Tubolare Martellato
Hammered Bars

H.150 X L.1450 mm.

Art. 15.157.116 □ 30 X 30
Art. 15.157.117 □ 40 X 20



Liscio / Smooth

H.180 X L.1300 mm.

Art. 15.157.118 ≙ 30 X 8
Art. 15.157.119 ≙ 35 X 8
Art. 15.157.120 ≙ 40 X 8

Martellato / Hammered

H.180 X L.1300 mm.

Art. 15.157.121 ≙ 30 X 8
Art. 15.157.122 ≙ 35 X 8
Art. 15.157.123 ≙ 40 X 8



Liscio / Smooth

H.190 X L.1000 mm.

Art. 15.157.124 ≙ 30 X 8
Art. 15.157.125 ≙ 35 X 10
Art. 15.157.126 ≙ 40 X 8

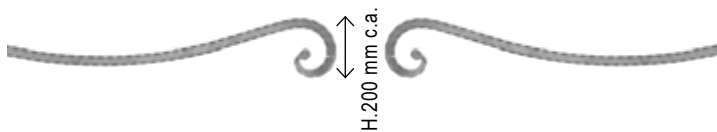

Sinistro / Left

Martellato / Hammered

H.200 X L.1000 mm.

Art. 15.157.127 ≙ 30 X 8
Art. 15.157.129 ≙ 35 X 8

Destro / Right

Martellato / Hammered

H.200 X L.1000 mm.

Art. 15.157.128 ≙ 30 X 8
Art. 15.157.130 ≙ 35 X 8

Liscio / Smooth

H.200 X L.1000 mm.

Art. 15.157.131 ≙ 30 X 8
Art. 15.157.132 ≙ 35 X 8

N.B.: Nel piatto liscio
sinistro o destro sono uguali.
Note: Right and left sides are equal in
smooth flat sections.

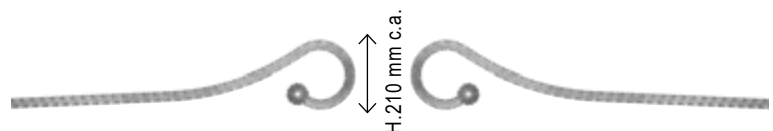

Sinistro / Left

Martellato / Hammered

H.210 X L.1000 mm.

Art. 15.157.133 ≙ 30 X 8
Art. 15.157.135 ≙ 35 X 8



Destro / Right

Martellato / Hammered

H.210 X L.1000 mm.

Art. 15.157.134 ≙ 30 X 8
Art. 15.157.136 ≙ 35 X 8

Sinistro / Left

Liscio / Smooth

H.210 X L.1000 mm.

Art. 15.157.137 ≙ 30 X 8
Art. 15.157.138 ≙ 35 X 8

Destro / Right

Liscio / Smooth

H.210 X L.1000 mm.

Art. 15.157.193 ≙ 30 X 8
Art. 15.157.194 ≙ 35 X 8

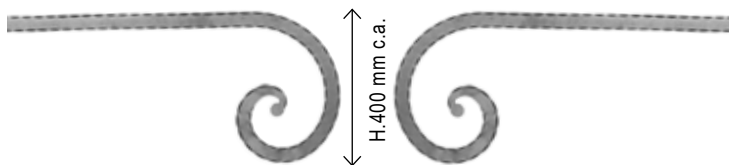

Sinistro / Left

Martellato / Hammered

H.400 X L.1000 mm.

Art. 15.157.139 ≙ 30 X 8
Art. 15.157.141 ≙ 35 X 8
Art. 15.157.143 ≙ 40 X 8

Destro / Right

Martellato / Hammered

H.400 X L.1000 mm.

Art. 15.157.140 ≙ 30 X 8
Art. 15.157.142 ≙ 35 X 8
Art. 15.157.144 ≙ 40 X 8

Liscio / Smooth

H.400 X L.1000 mm.

Art. 15.157.145 ≙ 30 X 8
Art. 15.157.146 ≙ 35 X 8
Art. 15.157.147 ≙ 40 X 8

N.B.: Nel piatto liscio
sinistro o destro sono uguali.
Note: Right and left sides are equal in
smooth flat sections.

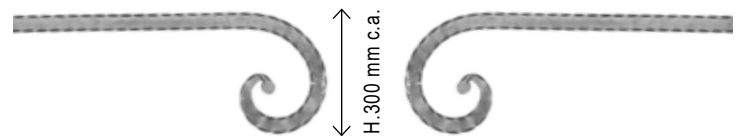

Sinistro / Left

Martellato / Hammered

H.300 X L.1000 mm.

Art. 15.157.148 ≙ 30 X 8
Art. 15.157.150 ≙ 35 X 8
Art. 15.157.152 ≙ 40 X 8

Destro / Right

Martellato / Hammered

H.300 X L.1000 mm.

Art. 15.157.149 ≙ 30 X 8
Art. 15.157.151 ≙ 35 X 8
Art. 15.157.153 ≙ 40 X 8

Liscio / Smooth

H.300 X L.1000 mm.

Art. 15.157.154 ≙ 30 X 8
Art. 15.157.155 ≙ 35 X 8
Art. 15.157.156 ≙ 40 X 8

N.B.: Nel piatto liscio
sinistro o destro sono uguali.
Note: Right and left sides are equal in
smooth flat sections.

Pezzi forniti singolarmente / *These pieces are furnished separately*

CIMASE E CANCELLI PEDONALI



Sinistro / Left
Martellato / *Hammered*
H.200 X L.1000 mm.
Art. 15.157.157 ≙ 30 X 8
Art. 15.157.159 ≙ 35 X 8
Art. 15.157.161 ≙ 40 X 8



Destro / Right
Martellato / *Hammered*
H.200 X L.1000 mm.
Art. 15.157.158 ≙ 30 X 8
Art. 15.157.160 ≙ 35 X 8
Art. 15.157.162 ≙ 40 X 8



Sinistro / Left
Martellato / *Hammered*
H.400 X L.1000 mm.
Art. 15.157.166 ≙ 30 X 8
Art. 15.157.168 ≙ 35 X 8
Art. 15.157.170 ≙ 40 X 8



Destro / Right
Martellato / *Hammered*
H.400 X L.1000 mm.
Art. 15.157.167 ≙ 30 X 8
Art. 15.157.169 ≙ 35 X 8
Art. 15.157.171 ≙ 40 X 8

Liscio / Smooth
H.200 X L.1000 mm.
Art. 15.157.163 ≙ 30 X 8
Art. 15.157.164 ≙ 35 X 8
Art. 15.157.165 ≙ 40 X 8

N.B.: Nel piatto liscio
sinistro o destro sono uguali.
*Note: Right and left sides are equal in
smooth flat sections.*

Liscio / Smooth
H.400 X L.1000 mm.
Art. 15.157.172 ≙ 30 X 8
Art. 15.157.173 ≙ 35 X 8
Art. 15.157.174 ≙ 40 X 8

N.B.: Nel piatto liscio
sinistro o destro sono uguali.
*Note: Right and left sides are equal in
smooth flat sections.*



Sinistro / Left
Martellato / *Hammered*
H.300 X L.800 mm.
Art. 15.157.175 ≙ 30 X 8
Art. 15.157.177 ≙ 35 X 8
Art. 15.157.179 ≙ 40 X 8



Destro / Right
Martellato / *Hammered*
H.300 X L.800 mm.
Art. 15.157.176 ≙ 30 X 8
Art. 15.157.178 ≙ 35 X 8
Art. 15.157.180 ≙ 40 X 8

Liscio / Smooth
H.300 X L.800 mm.
Art. 15.157.181 ≙ 30 X 8
Art. 15.157.182 ≙ 35 X 8
Art. 15.157.183 ≙ 40 X 8

N.B.: Nel piatto liscio
sinistro o destro sono uguali.
*Note: Right and left sides are equal in
smooth flat sections.*



Sinistro / Left
Martellato / *Hammered*
H.200 X L.500 mm.
Art. 15.157.184 ≙ 30 X 8
Art. 15.157.186 ≙ 35 X 8
Art. 15.157.188 ≙ 40 X 8



Destro / Right
Martellato / *Hammered*
H.200 X L.500 mm.
Art. 15.157.185 ≙ 30 X 8
Art. 15.157.187 ≙ 35 X 8
Art. 15.157.189 ≙ 40 X 8

Liscio / Smooth
H.200 X L.500 mm.
Art. 15.157.190 ≙ 30 X 8
Art. 15.157.191 ≙ 35 X 8
Art. 15.157.192 ≙ 40 X 8

N.B.: Nel piatto liscio
sinistro o destro sono uguali.
*Note: Right and left sides are equal in
smooth flat sections.*





Sinistro / Left
Martellato / Hammered
H. 370 x L. 1500 mm.
Art.15.157.200 \neq 30 x 8 mm

Liscio / Smooth
H. 370 x L. 1500 mm.
Art.15.157.206 \neq 30 x 8 mm



Destro / Right
Martellato / Hammered
H. 370 x L. 1500 mm.
Art.15.157.201 \neq 30 x 8 mm

N.B.: Il piatto liscio sinistro o destro sono uguali.
Note: Right and left sides are equal in smooth flat sections.

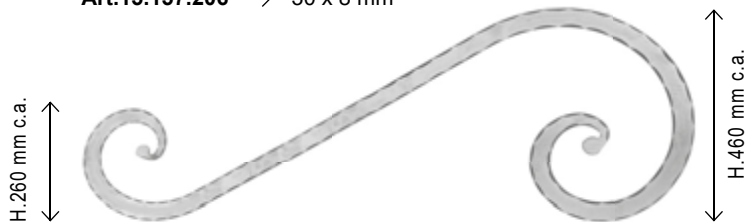

Sinistro / Left
Martellato / Hammered
H. 460 x L. 1500 mm.
Art.15.157.209 \neq 30 x 8 mm

Liscio / Smooth
H. 460 x L. 1500 mm.
Art.15.157.215 \neq 30 x 8 mm



Destro / Right
Martellato / Hammered
H. 460 x L. 1500 mm.
Art.15.157.210 \neq 30 x 8 mm

N.B.: Il piatto liscio sinistro o destro sono uguali.
Note: Right and left sides are equal in smooth flat sections.

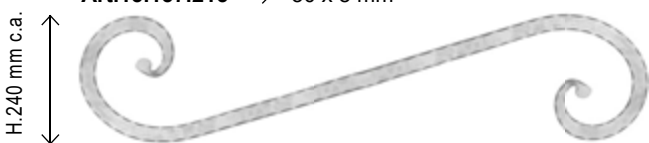

Sinistro / Left
Martellato / Hammered
H. 240 x L. 1500 mm.
Art.15.157.218 \neq 30 x 8 mm

Liscio / Smooth
H. 240 x L. 1500 mm.
Art.15.157.221 \neq 30 x 8 mm



Destro / Right
Martellato / Hammered
H. 240 x L. 1500 mm.
Art.15.157.219 \neq 30 x 8 mm

N.B.: Il piatto liscio sinistro o destro sono uguali.
Note: Right and left sides are equal in smooth flat sections.



Sinistro / Left
Martellato / Hammered
H. 360 x L. 1500 mm.
Art.15.157.224 \neq 30 x 8 mm

Liscio / Smooth
H. 360 x L. 1500 mm.
Art.15.157.227 \neq 30 x 8 mm



Destro / Right
Martellato / Hammered
H. 360 x L. 1500 mm.
Art.15.157.225 \neq 30 x 8 mm

N.B.: Il piatto liscio sinistro o destro sono uguali.
Note: Right and left sides are equal in smooth flat sections.



Sinistro / Left
Martellato / Hammered
H. 400 x L. 2100 mm.
Art.15.157.280 \neq 30 x 8 mm

Liscio / Smooth
H. 400 x L. 2100 mm.
Art.15.157.286 \neq 30 x 8 mm

N.B.: Il piatto liscio sinistro o destro sono uguali.
Note: Right and left sides are equal in smooth flat sections.

Destro / Right
Martellato / Hammered
H. 400 x L. 2100 mm.
Art.15.157.281 \neq 30 x 8 mm



≠ 70 X L.6 mm.
Art. 15.158 H. 300 mm.
Art. 15.159 H.2000 mm.
Art. 15.160 H.3000 mm.



Zincato/Galvanized Zincato/Galvanized
Art. 15.161 **Art. 15.162**
 A = 40 mm. A = 45 mm.
 B = 60 mm. B = 45 mm.
 C = 20 mm. C = 24 mm.



H. 160 X L.30 mm.
Art. 15.163



H. 130 X L.29 mm.
Art. 15.163.01



H. 100 X L.20 mm.
Art. 15.163.02

Cardini e cerniere forgiati a mano per portali / *Hand forged hinges for front doors*

Perno / Pin
Ø 16mm

Forgiato a mano / *Hand Forged*
 H. 328 x L. 110 mm
Art. 15.210 ≠ 8

Forgiato a mano / *Hand Forged*
 L. 780 mm
Art. 15.200 ≠ 40 x 8
 fori / holes Ø 16,5 mm

Forgiato a mano / *Hand Forged*
 L. 740 mm
Art. 15.201 ≠ 40 x 8
 fori / holes Ø 16,5 mm



Forgiato / *Forged*
 H. 525 x L. 105 mm
Art. 15.250 □ 30 mm



Forgiato / *Forged*
 H. 610 x L. 180 mm
Art. 15.251 □ 30 mm
Art. 15.251.01 □ 25 mm



Forgiato / *Forged*
 H. 920 x L. 220 mm
Art. 15.252 □ 30 mm
Art. 15.252.01 □ 25 mm



Forgiato / *Forged*
 H. 650 x L. 285 mm
Art. 15.253 □ 30 mm

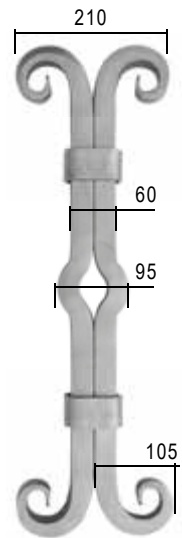

Forgiato / *Forged*
 H. 660 x L. 210 mm
Art. 15.254 □ 30 mm

NEW

NEW Art. 15.251.02 ≠ 50x20 mm

Tutte le parti di questo catalogo - foto comprese - sono di proprietà Euro-Fer. La riproduzione, anche parziale, è vietata in ogni forma e con ogni mezzo. / Every part of this catalogue - photos included - is Euro-Fer's property. All forms of copying are strictly prohibited.

COMPONENTI VARI PER ARREDAMENTO
VARIOUS DECOR ELEMENTS



L.120 mm.
Art. 16.001



H.210 X L.60 mm.
Art. 16.002



H.270 X L.60 mm.
Art. 16.003



Art. 16.003.01



Art. 16.003.02



H.410 X L.100 mm.
Art. 16.003.03 Ø 25 mm circa



Art. 16.003.04



H.350 X L.75 mm
Art. 16.003.05

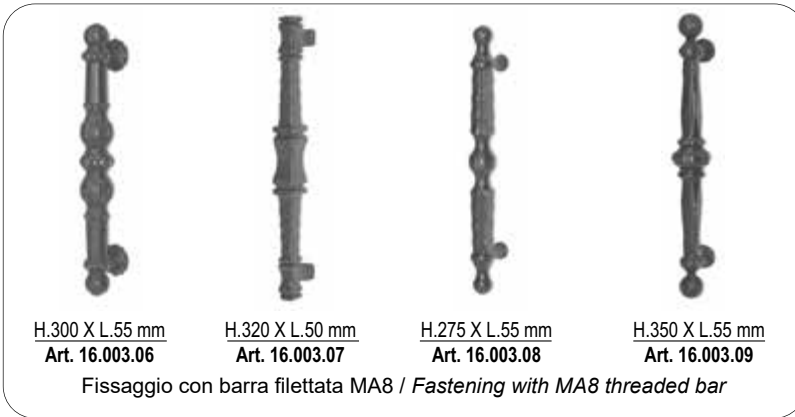

H.300 X L.55 mm
Art. 16.003.06

H.320 X L.50 mm
Art. 16.003.07

H.275 X L.55 mm
Art. 16.003.08

H.350 X L.55 mm
Art. 16.003.09



H.310 X L.50 mm
Art. 16.003.10
Forgiato / Forged



H.410 X L.70 mm
Art. 16.003.11
Forgiato / Forged

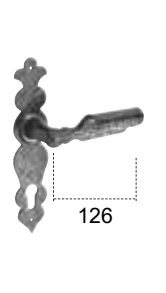

H.233 X L.50 mm.
Art. 16.004 (a coppia)

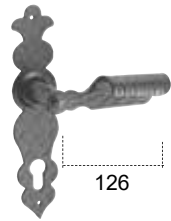

H.233 X L.50 mm.
Art. 16.005 (a coppia)



H.268 X L.49 mm.
Art. 16.006 (a coppia)



Art. 16.007

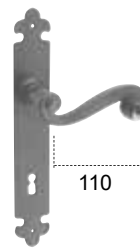

H.252 X L.38 mm.
Art. 16.008 (a coppia)



H.268 X L.49 mm.
Art. 16.009 (a coppia)



L.142 mm.
Art. 16.010 (a coppia)



L.142 mm.
Art. 16.011 (a coppia)



L.160 mm.
Art. 16.011.01 (a coppia)

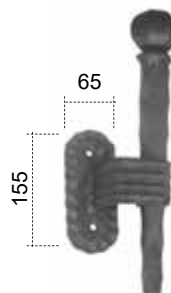

H.340 X L.100 mm.
Art. 16.011.02 (a coppia)



H.268 X L.49 mm.
Art. 16.012

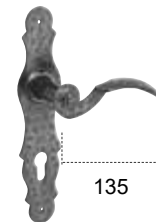

H.250 X L.56 mm.
Art. 16.013 (a coppia)



H.250 X L.56 mm.
Art. 16.014

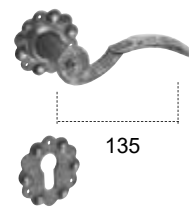

L.135 mm.
Art. 16.015 (a coppia)

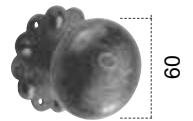

H.60 mm.
Art. 16.016

Borchia a 1 punta



Ø 12 mm.
Art. 16.018
Ø 15 mm.
Art. 16.018.01
Ø 20 mm.
Art. 16.018.02

Borchia a 2 punte

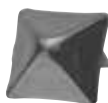

15 X 15 mm.
Art. 16.019
20 X 20 mm.
Art. 16.019.01



Art. 16.020

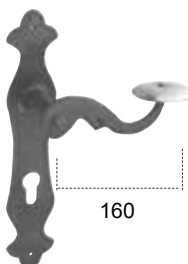

H.230 X L.50 mm.
Art. 16.021 (a coppia)



110
L.110 mm.
Art. 16.022



H.170 mm.
Art. 16.022.01



H.90 mm.
Art. 16.022.02

Sporgenza d'ingombro 110 mm.
Wall protusion = 110 mm.

Tutte le parti di questo catalogo - foto comprese - sono di proprietà Euro-Fer. La riproduzione, anche parziale, è vietata in ogni forma e con ogni mezzo. / Every part of this catalogue - photos included - is Euro-Fer's property. All forms of copying are strictly prohibited.



H.165 mm.
Art. 16.022.03
Sporgenza d'ingombro 55 mm.
Wall protusion = 55 mm.



H.200 mm.
Art. 16.022.04
Sporgenza d'ingombro 80 mm.
Wall protusion = 80 mm.



H.80 mm.
Art. 16.022.05
Sporgenza d'ingombro 40 mm.
Wall protusion = 40 mm.

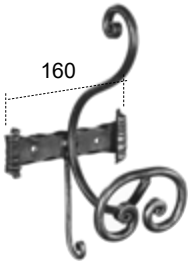

H.305 X L.160 mm.
Art. 16.022.06
Sporgenza d'ingombro 150 mm.
Wall protusion = 150 mm.

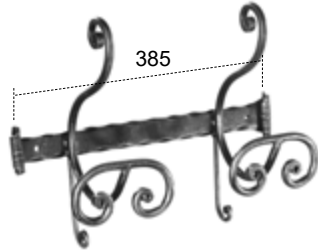

H.305 X L.385 mm.
Art. 16.022.07
Sporgenza d'ingombro 150 mm.
Wall protusion = 150 mm.

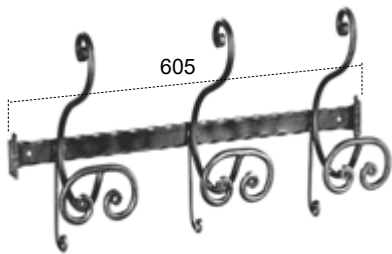

H.305 X L.605 mm.
Art. 16.022.08
Sporgenza d'ingombro 150 mm.
Wall protusion = 150 mm.

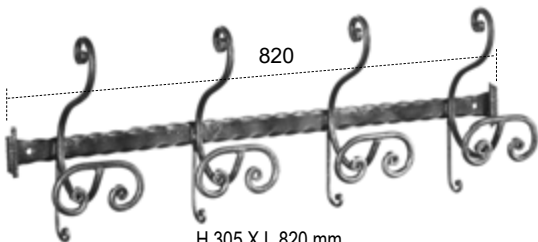

H.305 X L.820 mm.
Art. 16.022.09
Sporgenza d'ingombro 150 mm.
Wall protusion = 150 mm.



H 1860 mm.
Art. 16.022.10
Ingombro al pavimento Ø 600 mm.
Ingombro superiore Ø 500 mm.
Lower dimensions = 600 mm. Ø
Upper dimensions = 500 mm. Ø



Girevole / Revolving

H 1830 mm.
Art. 16.022.11
Ingombro al pavimento Ø 600 mm.
Ingombro superiore Ø 500 mm.
Lower dimensions = 600 mm. Ø
Upper dimensions = 500 mm. Ø



N.	Spessore 4 mm.
0	Art. 16.022.12
1	Art. 16.022.13
2	Art. 16.022.14
3	Art. 16.022.15
4	Art. 16.022.16
5	Art. 16.022.17
6	Art. 16.022.18
7	Art. 16.022.19
8	Art. 16.022.20
9	Art. 16.022.21

Bloccaggio con 2 viti e tasselli da 10
Locking with no. 2 size 10 screws
and expansion bolts

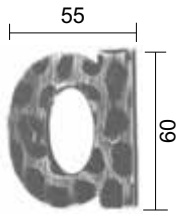

Spessore 4 mm.

A	Art. 16.022.22
B	Art. 16.022.23
C	Art. 16.022.24
D	Art. 16.022.25

Bloccaggio con 2 viti e tasselli da 10
Locking with no. 2 size 10 screws
and expansion bolts

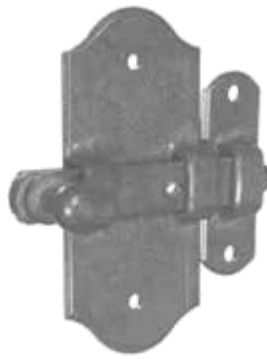

H.100 X L.85 mm.
Profondità 40 mm.

Art. 16.022.26

Spessore piastra d'appoggio 3 mm.
Support plate thickness = 3 mm.



H.45 X L.250 mm.
Profondità 40 mm.

Art. 16.022.27

Spessore piastra d'appoggio 2 mm.
Support plate thickness = 2 mm.

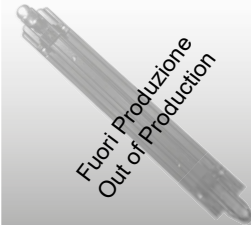

Art. 16.022.29

Ottone / Brass



H.65 X L.100 mm.

Art. 16.022.30

Fissaggio con tasselli da 10 mm.
Fastening with size 10 expansion bolts



H.125 X L.130 mm.

Art. 16.022.31

Fissaggio con tasselli da 10 mm.
Fastening with size 10 expansion bolts



H.70 X L.120 mm.

Art. 16.022.32

Fissaggio con tasselli da 10 mm.
Fastening with size 10 expansion bolts



Ottone / Brass

Ø 120 Profondità 40 mm.

Art. 16.022.33

Fissaggio con barra filettata MA 6
Fastening with MA 6 threaded bar

Ø 140 Profondità 40 mm.

Art. 16.022.34

Fissaggio con barra filettata MA 6
Fastening with MA 6 threaded bar

Elementi in ottone / Knockers and Handles



H 140 Profondità 40 mm.

Art. 16.022.35

Fissaggio con barra filettata MA 6
Fastening with MA 6 threaded bar



Art. 16.022.36

Elementi in ottone / Knockers and Handles



H 200 Profondità 60 mm.

Art. 16.022.39

Fissaggio con barra filettata MA 6
Fastening with MA 6 threaded bar



H 200 Profondità 60 mm.

Art. 16.022.41

Fissaggio con barra filettata MA 6
Fastening with MA 6 threaded bar



H. 140 x L.140 mm

Art. 16.022.43

H. 100 x L.100 mm

Art. 16.022.44

H. 55 x L.55 mm

Art. 16.022.45

Fissaggio con barra filettata MA6 / Fastening with MA6 threaded bar

H 250 Profondità 60 mm

Art. 16.022.40

Fissaggio con barra filettata MA 6
Fastening with MA 6 threaded bar

Fuori Produzione
Out of Production

H 250 Profondità 60 mm.

Art. 16.022.42

Fissaggio con barra filettata MA 6
Fastening with MA 6 threaded bar



Venduti in coppia
Sold in pairs

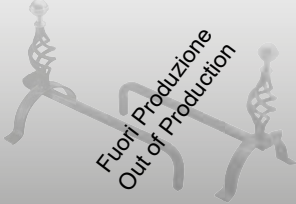

Fuori Produzione
Out of Production

Art. 16.023



H.630 mm.
Art. 16.024

Venduti in coppia
Sold in pairs

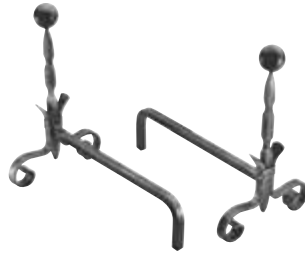

H.400 X L.420 mm.
Art. 16.025



H.600 mm.
Art. 16.026

Venduti in coppia
Sold in pairs



H.460 X L.420 mm.
Art. 16.027

Venduti in coppia
Sold in pairs



H.460 X L.610 mm.
Art. 16.028.01



H.870 X L.375 mm.
Art. 16.028.02

Venduti in coppia
Sold in pairs



H.465 X L.530 mm.
Art. 16.028.03



H.750 X L.360 mm.
Art. 16.028.05



Fuori Produzione
Out of Production

Art. 16.029

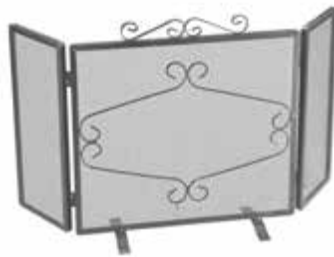

H.500 X L.900 mm.
Art. 16.030



H.480 X L.700 mm.
Art. 16.032



H.510 X L.1000 mm.
Art. 16.032.02
Profondità appoggio 180 mm.
Support depth = 180 mm.



Fuori Produzione
Out of Production

Art. 16.032.03



Fuori Produzione
Out of Production

Art. 16.032.04



H.180 X L.400 mm.
Art. 16.033
Profondità appoggio 300 mm.
Support depth = 300 mm.



H.410 X L.260 mm.
Sporgenza d'ingombro 90 mm.
Wall protrusion = 90 mm

- Art. 16.034** Rosso / Red
Art. 16.036 Metallizzato / Metallized
Art. 16.037 Verde / Green
Art. 16.038 Grigio ghisa / Cast iron grey
Art. 16.039 Nero / Black



H.465 X L.298 mm.
Sporgenza d'ingombro 96 mm.
Wall protrusion = 96 mm

- Art. 16.040** Rosso / Red
Art. 16.041 Bordeaux / Red-Wine
Art. 16.042 Metallizzato / Metallized



H.360 X L.275 mm.
Art. 16.045.01
Sporgenza d'ingombro 115 mm.
Wall protrusion = 115 mm



H.410 X L. 250 mm.
Art. 16.045.03 rosso / red
Art. 16.045.04 verde / red
Sporgenza d'ingombro 100 mm.
Wall protrusion 100 mm.



- Art. 16.046** Patina Oro / Gold Patina 0,2 lt.
Art. 16.047 Patina Rame / Copper Patina 0,2 lt.
Art. 16.049 Patina Argento / Silver Patina 0,2 lt.

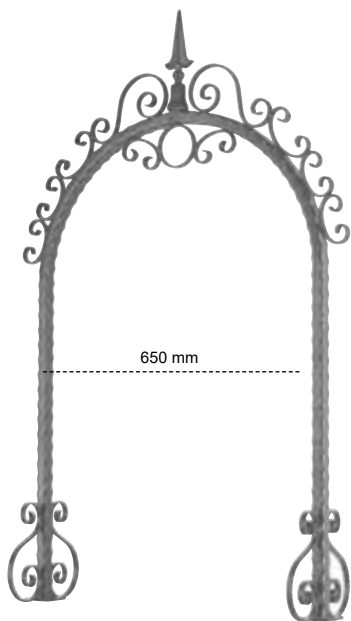

Martellato / *Hammered*
Art. 16.120

H 1340 X L.810 mm
Tubo □ 30 mm

Ricci Modello Scala / *Scala Model Scrolls*
≠ 14 X 6 mm



H. 280 x L.285 mm
Colore / *Colour*
Art. 16.151 Grigio / *Grey*



base 90 X H.135 mm.
Art. 16.150

Portacandele
Candle holder



H. 330 x L.465 mm
Colore / *Colour*
Art. 16.152 Grigio / *Grey*

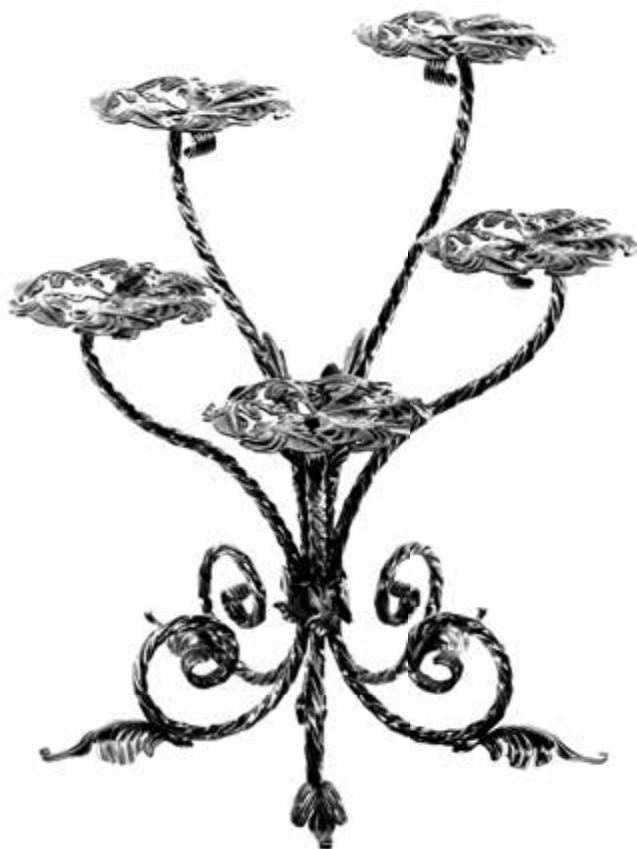

H. 730 x L.680 mm
Colore / *Colour*
Art. 16.160 Grigio / *Grey*
Art. 16.160.01 Rame / *Copper*



Art. 16.161
Art. 16.162

Finali per tubo tenda / Ends for curtain tube



H.150 X L.50 mm - Base Ø 20 mm
Art. 16.105 nero / black



H.240 X L.55 mm - Base Ø 20 mm
Art. 16.106 nero / black



H.205 X L.35 mm - Base Ø 20 mm
Art. 16.107 nero / black

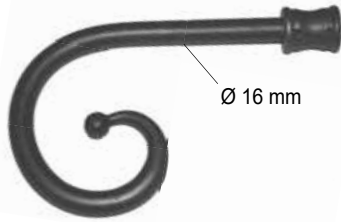

H.215 X L.125 mm - Base Ø 20 mm
Art. 16.108 nero / black

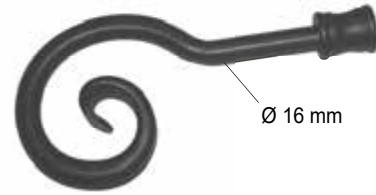

H.235 X L.110 mm - Base Ø 20 mm
Art. 16.109 nero / black

Tubo per tenda / Curtain tube



L.2000 - Ø 20 mm
Art. 16.115 nero / black

L.3000 - Ø 20 mm
Art. 16.116 nero / black

Fissaggio per supporto tubo / Wall fixing for tube support



Ø esterno / out 67 mm
Ø interno / in 17 mm

Art. 16.113C nero / black



Art. 16.113F

Anelli tenda / Curtain rings

Gancetto non fornito / Hook not supplied

pz. 20
Diam. 40 mm
Art. 16.111 nero / black

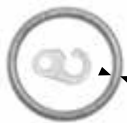

Ø esterno / out 40 mm
Ø interno / in 32 mm

Ø 4 mm

Supporto a parete per tubo / Wall support for tube



Per tubo / For tube - Ø 20 mm
Art. 16.112 nero / black

Supporto a sbalzo per tubo / Cantilever support for tube



L. 175 X 35 mm.
Per tubo / For tube - Ø 20 mm
Art. 16.113 nero / black

Installazione con supporto a sbalzo + finali per tubo / Installation with cantilever support + ends for curtain tube

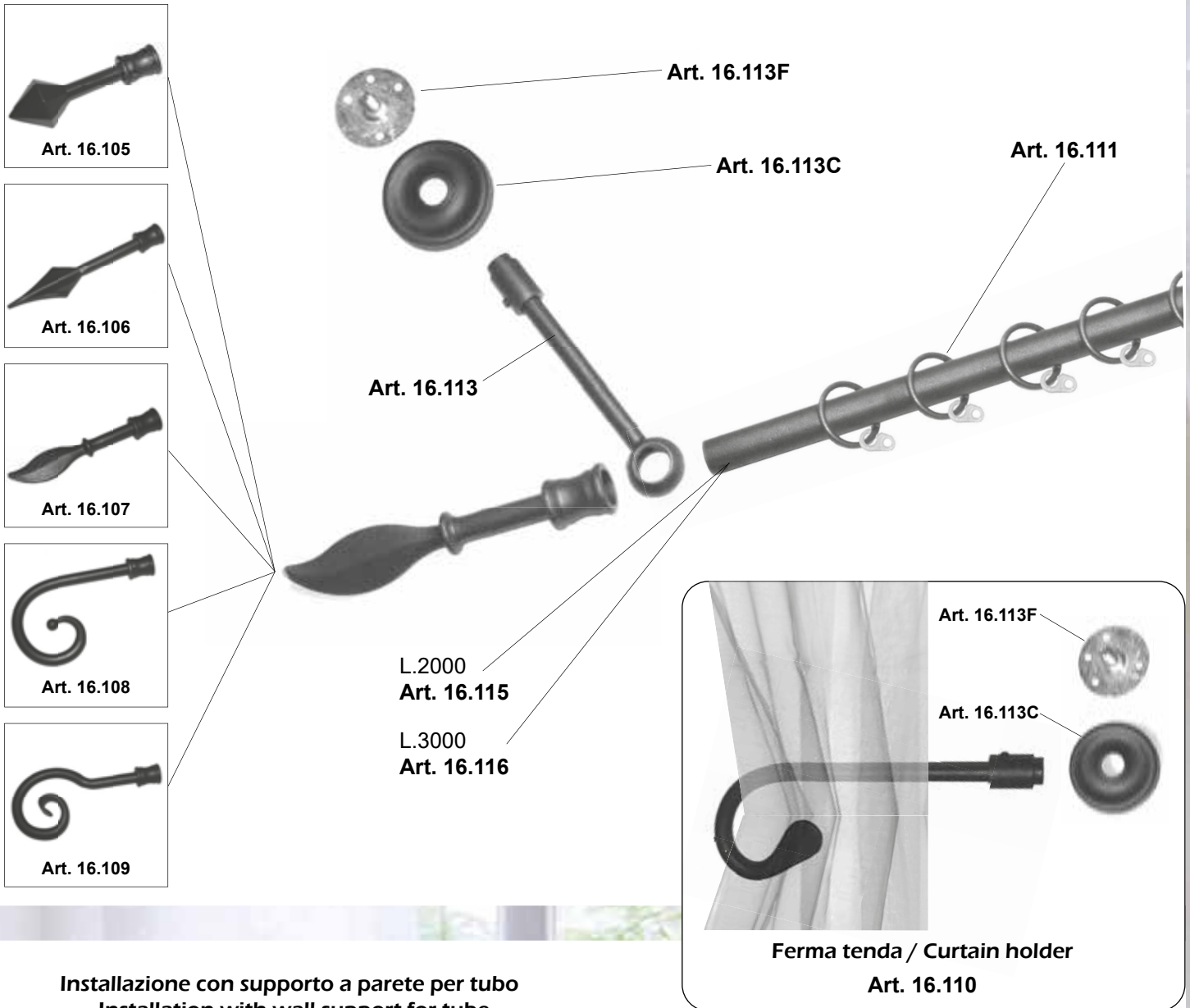

Installazione con supporto a parete per tubo
Installation with wall support for tube

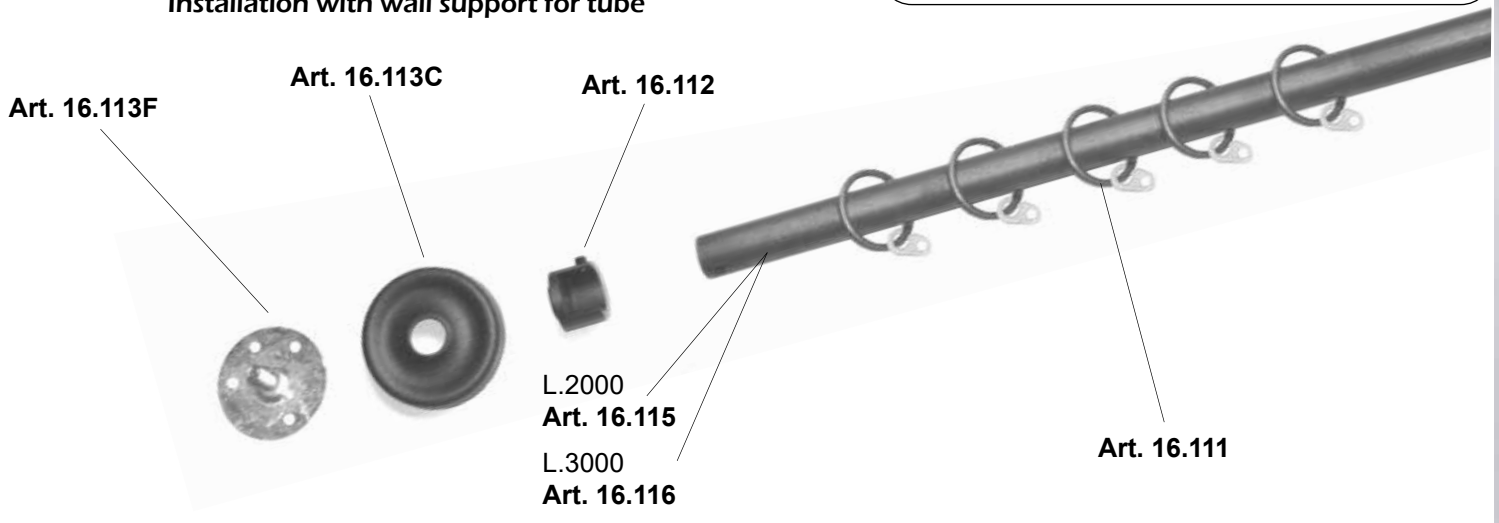



Nero / Black
Art. 16.200 H.1000 X L.900 mm.



Art. 16.201



Nero / Black
Art. 16.203 H.1000 X L.900 mm.



Nero / Black
Art. 16.204 H.1000 X L.900 mm.



Nero / Black
Art. 16.205 H.1000 X L.900 mm.



Nero / Black
Art. 16.206 H.1000 X L.900 mm.



Nero / Black
Art. 16.207 H.1000 X L.900 mm.



Nero / Black
Art. 16.208 H.1000 X L.900 mm.



Nero / Black
Art. 16.209 H.1000 X L.900 mm.



Nero / Black
Art. 16.210 H.1000 X L.900 mm.



Nero / Black
Art. 16.212 H.1000 X L.900 mm.



Nero / Black
Art. 16.280
Base di supporto per segnvento
Fixing support



Nero / Black
Art. 16.284
Base di supporto a parete per segnvento
Walls support



Art. 16.285
Bussola per regolazione segnvento
Compass

1. Avvitare i punti cardinali con un cacciavite. Fare attenzione che le lettere siano nella giusta posizione.
2. Collocare l'anemometro sull'asta.
3. Introdurre la parte superiore del segna vento sull'asta ed avvitarla fino in fondo con un cacciavite.

1. Screw the cardinal points through a screwdriver. Check that the letters are in the right position.
2. Place the anemometer on the rod.
3. Insert the upper part of the weather vanes in the rod and screw it in through a screwdriver.

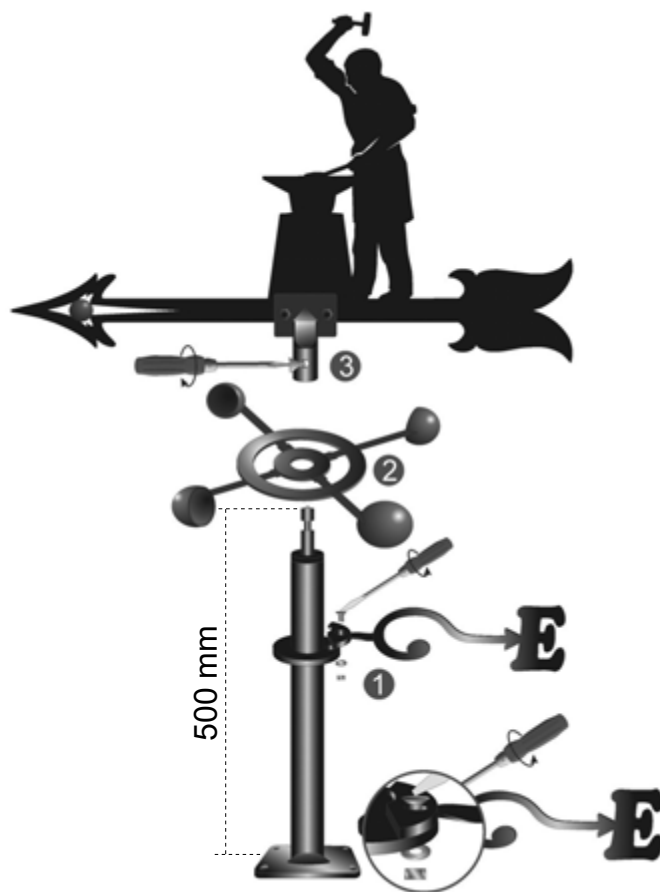

Istruzioni:

1. Nel collocare il supporto di fissaggio regolabile o quello da parete, bisogna tener presente che la parte piana dove si fisserà il palo del segnavento deve essere perfettamente a livello.
2. Una volta fissato il supporto, avvitare il palo completamente montato tramite le 4 viti, senza però fissarle del tutto. Orientare quindi il segnavento servendosi della bussola (in tutte le bussole la freccia segna il nord magnetico). Con il braccio della lettera "N" rivolto verso nord, fissare con forza le viti.

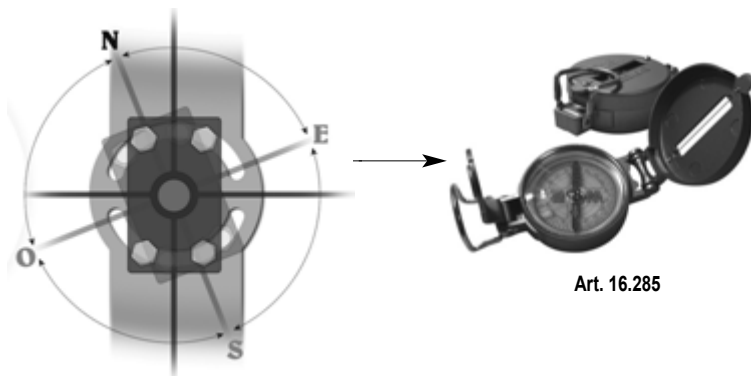

Art. 16.285

Instructions:

1. Either if you are placing the adjustable fixing support, or the walls one, you will need to consider that the flat surface where you place the pole of the weather vanes needs to be completely level.
2. Once the support has been fixed, screw the mounted pole using the 4 screws, but leave them slightly unscrewed then, orient the weather vanes through the compass (all compasses have the arrow pointing at the magnetic north) and with the compass arm of letter "N" pointing at the north, finally screw the screws completely to the end.

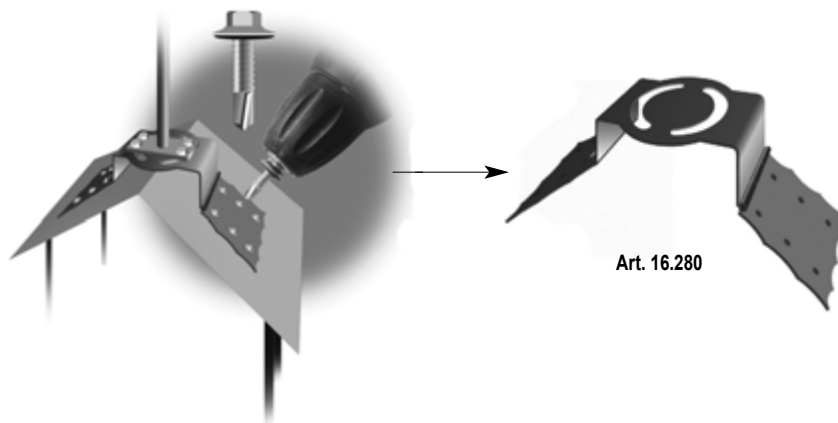

Art. 16.280

Insegne: non sono incluse nel prezzo del porta insegna – possiamo realizzarle su richiesta, con taglio laser, personalizzate con nome o logo dell'attività.
Signs: they are not included in the price of the sign holder - we can make them on request, with laser cutting, personalized with the name or logo of your business.

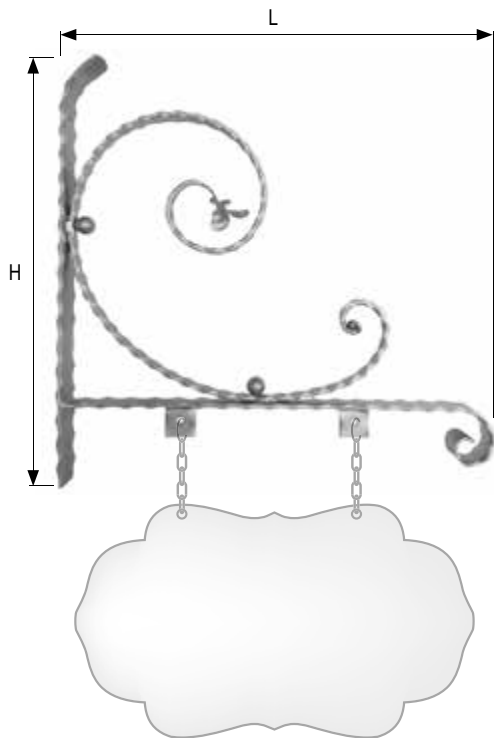

H. 550 x L. 570 mm
Art. 16.300
≠ 40x6
riccio / scroll ≠ 16x8



H. 500 x L. 1000 mm
Art. 16.312
≠ 60x6 liscio / smooth
riccio / scrolls 04.12004
tubo / tube 40 x 40 martellato / hammered

Insegna luminosa!
E' possibile effettuare un foro per il passaggio dei filo all'interno del tubolare.

Lighted sign!
It is possible to make a hole for the passage of the wire.



H. 500 x L. 1000 mm
Art. 16.313
≠ 60x6 liscio / smooth
riccio / scrolls 04.12004
tubo liscio / tube smooth Ø 35

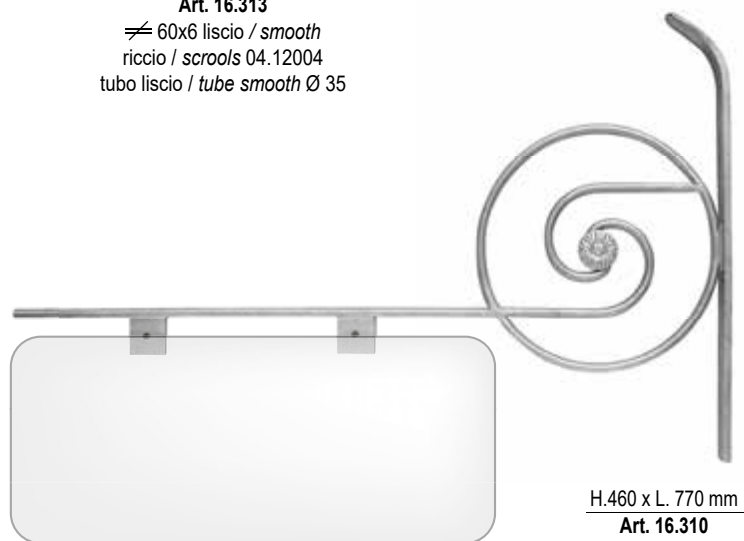

H.460 x L. 770 mm
Art. 16.310
≠ 35x10 liscio / smooth
rosone / rosette Ø 10

Insegne: non sono incluse nel prezzo del porta insegna – possiamo realizzarle su richiesta, con taglio laser, personalizzate con nome o logo dell'attività.
Signs: they are not included in the price of the sign holder - we can make them on request, with laser cutting, personalized with the name or logo of your business.



H. 500 x L. 1000 mm
Art. 16.314
≠ 60x6 liscio / smooth
riccio / scrolls 30x8
lancia / spears 13.110.04
tubo liscio / tube smooth Ø 40

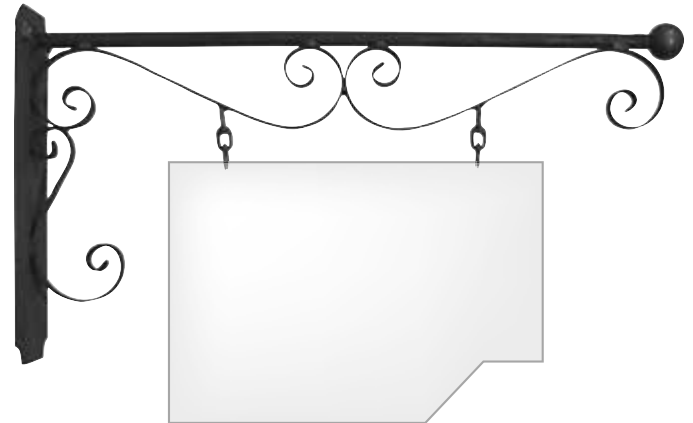

H. 500 x L. 1000 mm
Art. 16.315
≠ 60x6 liscio / smooth
ricci / scrolls 30x8
tubo liscio / tube smooth Ø 40



H. 500 x L. 1000 mm
Art. 16.317
≠ 40x8 liscio / smooth

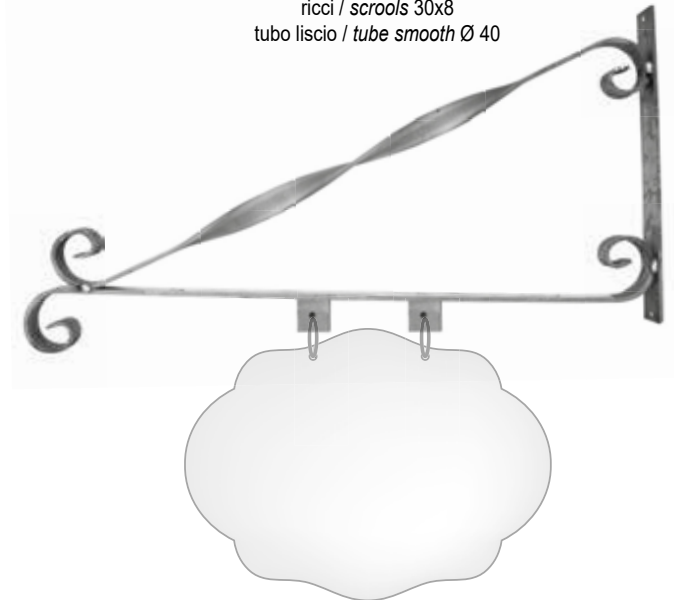

H. 500 x L. 1000 mm
Art. 16.316
≠ 60x6 liscio / smooth
ricci / scrolls 30x8



**COMPONENTI IN GHISA
ELEMENTS IN CAST IRON**



Ferro fuso / Cast steel
H.65 x L.40 mm

Art. CS.13.142 □ 12,5



Ferro fuso / Cast steel
H.67 x L.45 mm

Art. CS.13.151 □ 12,5
Art. CS.13.152 □ 14,5
Art. CS.13.153 □ 16,5



Ferro fuso / Cast steel
H.38 x L.40 mm

Art. CS.13.900 □ 14,5
Art. CS.13.900.01 □ 16,5
Art. CS.13.900.02 □ 12,5



Ferro fuso / Cast steel
H.65 x L.40 mm

Art. CS.13.901 □ 14,5
Art. CS.13.901.01 □ 16,5
Art. CS.13.901.02 □ 12,5



Ghisa / Cast iron
H.45 x L.40 mm

Art. CI.13.902 □ 12,5
Art. CI.13.903 □ 14,5

**ARTICOLI ZINCATI A FREDDO
COLD GALVANIZED ARTICLES**

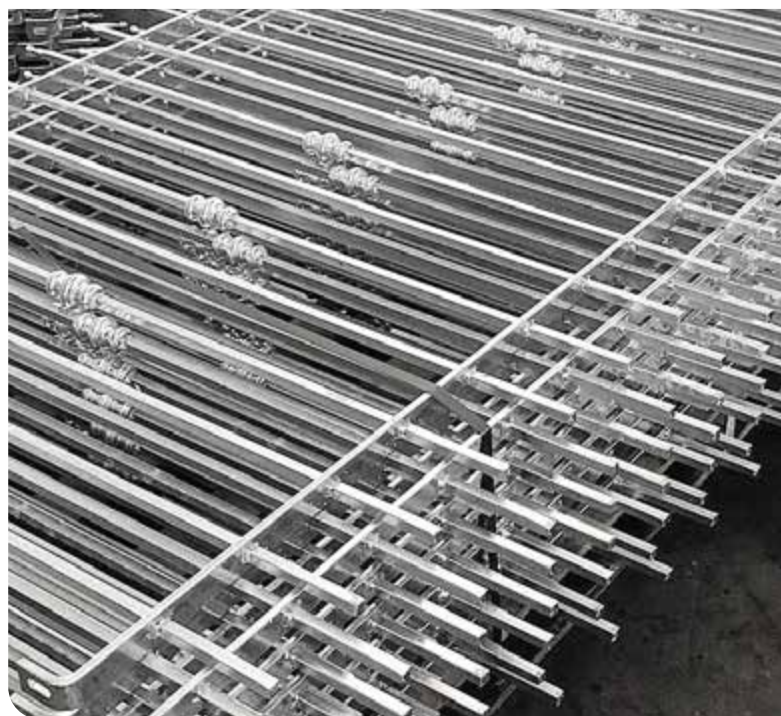
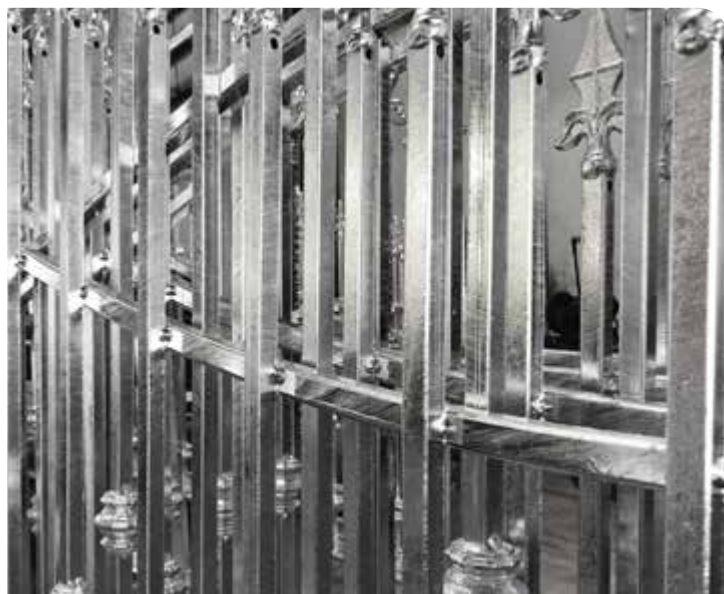

Tutte le parti di questo catalogo - foto comprese - sono di proprietà Euro-Fer. La riproduzione, anche parziale, è vietata in ogni forma e con ogni mezzo. / Every part of this catalogue - photos included - is Euro-Fer's property. All forms of copying are strictly prohibited.



Liscio / Smooth
H.115 X L.75 mm
Art. 01.094.01.ZF ≠ 14 x 6 mm



Tondo / Round
H.350 X L.150 mm.
Art. 01.369.ZF Ø 14
Art. 01.370.ZF Ø 16

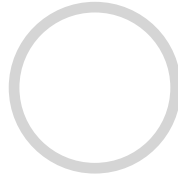

Liscio / Smooth
H.100 mm
Art. 02.031.ZF ≠ 12 x 6 mm



Liscio / Smooth
H.1500 mm
Art. 04.106.15.ZF Ø 14 mm
H.1500 mm
Art. 04.106.19.ZF Ø 16 mm



FORO QUADRO
SQUARE HOLE



FORO TONDO
ROUND HOLE



FORO QUADRO
SQUARE HOLE

H.2000 mm.
Art. 08.001.ZF fori / hole □ 14 INT.140 mm - n°14 fori / holes
Art. 08.002.ZF fori / hole □ 16 INT.150 mm - n°13 fori / holes
Art. 08.006.01.ZF fori / hole □ 12 INT.120 mm - n°16 fori / holes

H.2000 mm.
Art. 08.023.ZF fori / hole Ø 14 INT.140 mm - n°14 fori / holes
Art. 08.024.ZF fori / hole Ø 16 INT.150 mm - n°13 fori / holes
Art. 08.025.ZF fori / hole Ø 18 INT.160 mm - n°12 fori / holes
Art. 08.029.01.ZF fori / hole Ø 12 INT.120 mm - n°16 fori / holes
Art. 08.115.ZF fori / hole Ø 14 INT.125 mm - n°15 fori / holes
Art. 08.116.ZF fori / hole Ø 16 INT.125 mm - n°15 fori / holes

INT.125
15 Fori per barra
15 Holes for bar
H.2000 mm. Foro □ 12
Art. 08.059.ZF ≠ 30 x 8
Art. 08.063.ZF ≠ 40 x 8



Piatto Mezzo Tondo /
Half-Round Flat
H.6000 mm.
Art. 12.059.01.ZF ≠ 30x8
Art. 12.063.01.ZF ≠ 40x8
Art. 12.064.01.ZF ≠ 40x10
Art. 12.066.01.ZF ≠ 50x10



Sagomato / Contoured
H.6000 mm.
Art. 12.085.ZF ≠ 50 x 14
Art. 12.085.01.ZF ≠ 40 x 12
Art. 12.085.02.ZF ≠ 45 x 12
Art. 12.085.03.ZF ≠ 60 x 12 **NEW**



H.400 mm.
Art. 12.086.ZF ≠ 50 x 14
Art. 12.086.01.ZF ≠ 40 x 12



H.170 X L.400 mm
Art. 12.087.ZF ≠ 50 x 14
Art. 12.087.01.ZF ≠ 40 x 12

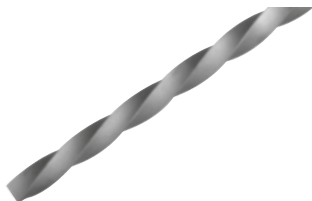

H.6000 mm.
Art. 12.158.ZF □ 12x12 mm.
Art. 12.159.ZF □ 14x14 mm.



Quadro Martellato /
Hammered Square
H.6000 mm.
Art. 12.182.ZF □ 12x12 mm.
Art. 12.183.ZF □ 14x14 mm.



H.125 X L.60 mm.
Art. 13.077.ZF Ø 32 mm



H.140 X L.60 mm.
Art. 13.078.ZF □ 15 mm



H.155 X L.65 mm.
Art. 13.080.ZF Ø 16 mm

Nuove Borchie in Tubo / New Studs in Tube



H.39 x L.40 mm.

Art. 13.135.ZF Ø 12,5 mm
Art. 13.136.ZF Ø 14,5 mm
Art. 13.137.ZF Ø 16,5 mm



H.67 x L.40 mm.

Art. 13.138.ZF Ø 12,5 mm
Art. 13.139.ZF Ø 14,5 mm
Art. 13.140.ZF Ø 16,5 mm



Borchie Svasate /
Countersunk Ironstud
H.39 X L.40 mm.

Art. 13.137.B.ZF Ø 16,5 mm



H.67 x L. 40 mm

Art. TB.13.138.ZF Ø 12,5 NEW
Art. TB.13.139.ZF Ø 14,5
Art. TB.13.140.ZF Ø 16,5



H.67 x L.40 mm.

Art. 13.142.ZF □ 12,5 mm

H.36 x L.37 mm.

Art. 13.135.E.ZF Ø 12,5 mm
Art. 13.136.E.ZF Ø 14,5 mm
Art. 13.137.E.ZF Ø 16,5 mm

H.63 x L.37 mm.

Art. 13.138.E.ZF Ø 12,5 mm
Art. 13.139.E.ZF Ø 14,5 mm
Art. 13.140.E.ZF Ø 16,5 mm



H.67 X L.45 mm.

Art. 13.148.ZF Ø 16,5 mm



H.25 x L.35 mm.

Art. 13.167.ZF Ø 12,5 mm

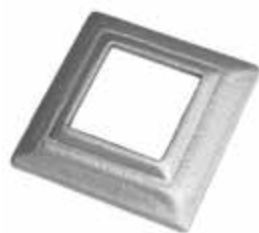

H.80 x 80 H. 20 mm.

Art. 13.319.ZF foro □ 30,5 mm
Art. 13.320.ZF foro □ 35,5 mm
Art. 13.321.ZF foro □ 40,5 mm

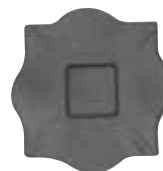

□ 100x100 mm

Art. 13.311.ZF
sede/seat □ 30x30 mm



□ 100x100 mm

Art. 13.313.ZF
foro/hole □ 30x30 mm

H.60 x 60 H. 20 mm.

Art. 13.322.ZF foro □ 25,5 mm
Art. 13.323.ZF foro □ 30,5 mm

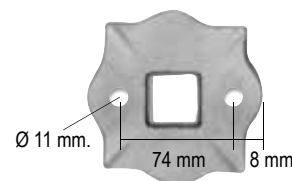

H.100X L.100 mm. - sp.10 mm.

Art. 13.313.2F.ZF □ Foro 30 mm. NEW



Ferro fuso / Cast steel
H.38 x L.40 mm

Art. CS.13.900.ZF □ 14,5



Ferro fuso / Cast steel
H.65 x L.40 mm

Art. CS.13.901.ZF □ 14,5
Art. CS.13.901.01.ZF □ 16,5



Copricolonna / Post Caps

Art. 15.052.ZF □ 30x30 mm
Art. 15.053.ZF □ 40x40 mm
Art. 15.054.ZF □ 50x50 mm
Art. 15.055.ZF □ 60x60 mm

Copricolonna / Post Caps

Art. 15.056.ZF □ 80x80 mm
Art. 15.057.ZF □ 100x100 mm
Art. 15.058.ZF □ 120x120 mm
Art. 15.059.ZF □ 150x150 mm



Sfera vuota / Hollow sphere

Art. 15.059.05.ZF □ 30x30 Ø 40 mm
Art. 15.059.06.ZF □ 40x40 Ø 40 mm
Art. 15.059.07.ZF □ 50x50 Ø 50 mm

Sfera vuota / Hollow sphere

Art. 15.059.08.ZF □ 60x60 Ø 60 mm
Art. 15.059.09.ZF □ 80x80 Ø 80 mm
Art. 15.059.10.ZF □ 100x100 Ø 100 mm



ARTICOLI ZINCATI A FREDDO COLD GALVANIZED ARTICLES

ZF

Liscio / Smooth
H.6000 mm.

Tondo.ZF. 6x6000 mm
Tondo.ZF. 8x6000 mm
Tondo.ZF. 10x6000 mm
Tondo.ZF. 12x6000 mm

Liscio / Smooth
H.6000 mm.

Tondo.ZF. 14x6000 mm
Tondo.ZF. 16x6000 mm
Tondo.ZF. 18x6000 mm
Tondo.ZF. 20x6000 mm

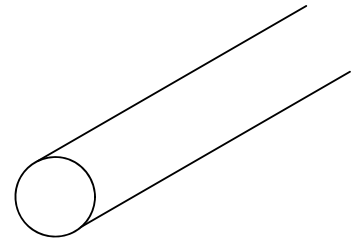

Liscio / Smooth
H.6000 mm.

Piatto.ZF ≠ 20 x 3
Piatto.ZF ≠ 20 x 4
Piatto.ZF ≠ 20 x 5
Piatto.ZF ≠ 20 x 10
Piatto.ZF ≠ 25 x 3
Piatto.ZF ≠ 25 x 4
Piatto.ZF ≠ 25 x 5
Piatto.ZF ≠ 25 x 8 **NEW**

Liscio / Smooth
H.6000 mm.

Piatto.ZF ≠ 30 x 3
Piatto.ZF ≠ 30 x 4
Piatto.ZF ≠ 30 x 5
Piatto.ZF ≠ 30 x 6
Piatto.ZF ≠ 30 x 8
Piatto.ZF ≠ 30 x 10
Piatto.ZF ≠ 30 x 20

Liscio / Smooth
H.6000 mm.

Piatto.ZF ≠ 40 x 4
Piatto.ZF ≠ 40 x 5
Piatto.ZF ≠ 40 x 8
Piatto.ZF ≠ 40 x 10
Piatto.ZF ≠ 50 x 5
Piatto.ZF ≠ 50 x 8
Piatto.ZF ≠ 50 x 10
Piatto.ZF ≠ 60 x 5

Liscio / Smooth
H.6000 mm.

Piatto.ZF ≠ 80 x 5
Piatto.ZF ≠ 100 x 5 **NEW**

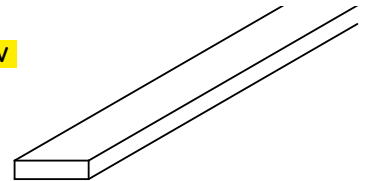

Liscio / Smooth
H.6000 mm.

Angolare.ZF □ 20 x 20 x 3
Angolare.ZF □ 25 x 25 x 4
Angolare.ZF □ 30 x 30 x 3
Angolare.ZF □ 30 x 30 x 5
Angolare.ZF □ 35 x 35 x 5

Liscio / Smooth
H.6000 mm.

Angolare.ZF □ 40 x 40 x 5
Angolare.ZF □ 45 x 45 x 5
Angolare.ZF □ 50 x 50 x 5
Angolare.ZF □ 60 x 60 x 5

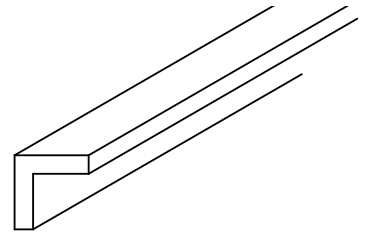

Liscio / Smooth
H.6000 mm.

Profilo.ZF T 30 x 30 x 4
Profilo.ZF T 35 x 35 x 4,5
Profilo.ZF T 40 x 40 x 5
Profilo.ZF T 50 x 50 x 6

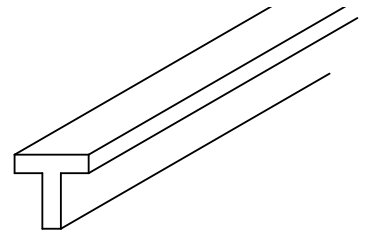

Liscio / Smooth
H.6000 mm.

Quadro.ZF □ 14x6000 mm
Quadro.ZF □ 16x6000 mm

Liscio / Smooth
H.6000 mm.

Quadro.ZF □ 10x6000 mm
Quadro.ZF □ 12x6000 mm
Quadro.ZF □ 20x6000 mm
Quadro.ZF □ 30x6000 mm

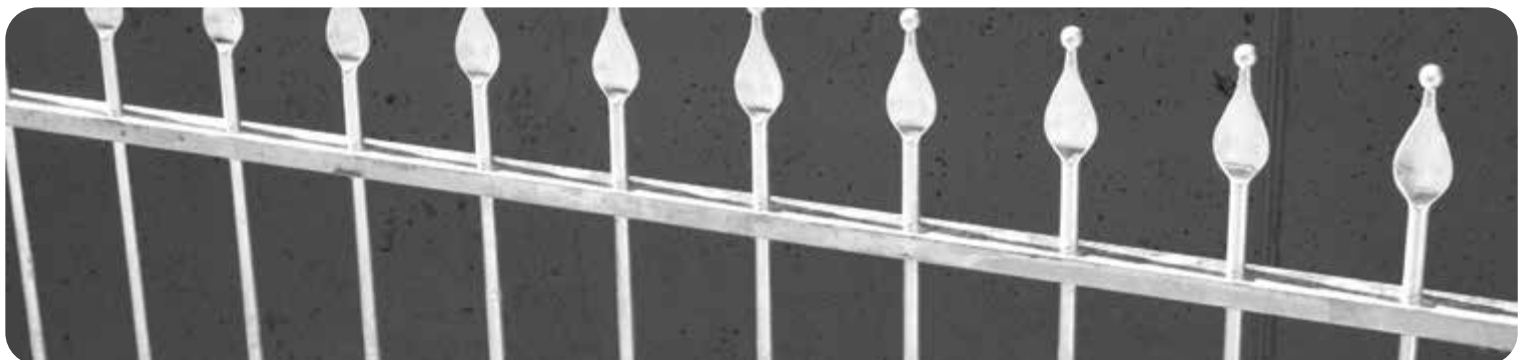
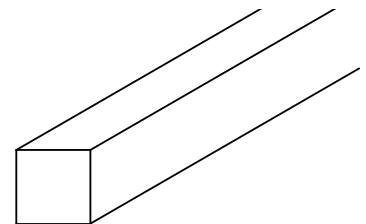

Art. LB1000X2000.20/10.ZF	Lamiera Bugnata / <i>Teardrop patterned steel sheet</i> 1000x2000mm sp. 20/10
Art. LB1000X2000.25/10.ZF	Lamiera Bugnata / <i>Teardrop patterned steel sheet</i> 1000x2000mm sp. 25/10
Art. LB1000X2000.30/10.ZF	Lamiera Bugnata / <i>Teardrop patterned steel sheet</i> 1000x2000mm sp. 30/10
Art. LB1250X2500.20/10.ZF	Lamiera Bugnata / <i>Teardrop patterned steel sheet</i> 1250x2500mm sp. 20/10
Art. LB1250X2500.25/10.ZF	Lamiera Bugnata / <i>Teardrop patterned steel sheet</i> 1250x2500mm sp. 25/10
Art. LB1250X2500.30/10.ZF	Lamiera Bugnata / <i>Teardrop patterned steel sheet</i> 1250x2500mm sp. 30/10
Art. LB1500X3000.25/10.ZF	Lamiera Bugnata / <i>Teardrop patterned steel sheet</i> 1500x3000mm sp. 25/10
Art. LB1500X3000.30/10.ZF	Lamiera Bugnata / <i>Teardrop patterned steel sheet</i> 1500x3000mm sp. 30/10

*A seconda delle diponibilita' del magazzino la bugna puo' essere tronca oppure affusolata
Depending on the availability of the warehouse the drop could be truncated or tapered*

Lamiera Bugnata Tronca /
Teardrop patterned steel sheet (truncated drop)



Lamiera Bugnata Affusolata /
Teardrop patterned steel sheet (tapered drop)

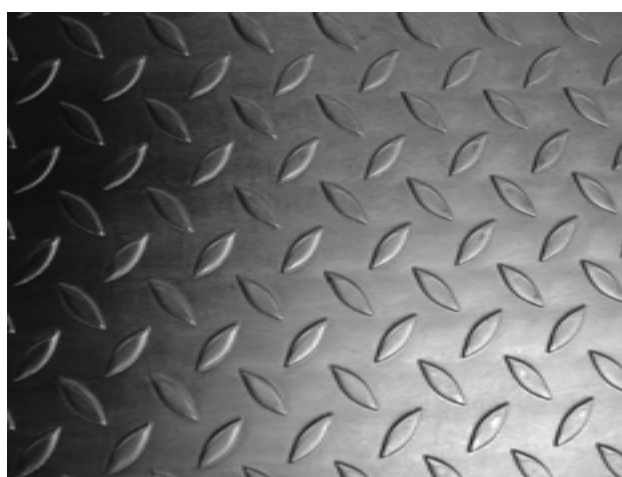

Art. LS1000X2000.30/10.ZF
Lamiera Striata / *Diamond patterned steel sheet*
1000x2000mm sp. 30/10

Art. LS1250X2500.30/10.ZF
Lamiera Striata / *Diamond patterned steel sheet*
1250x2500mm sp. 30/10

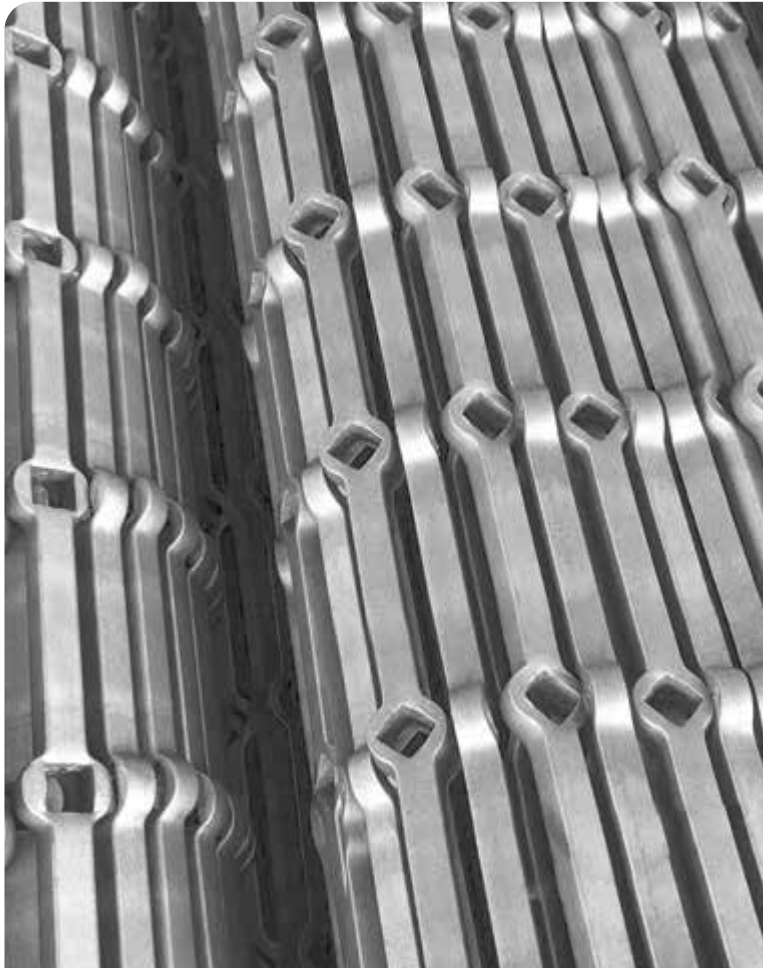

Tutte le parti di questo catalogo - foto comprese - sono di proprietà Euro-Fer. La riproduzione, anche parziale, è vietata in ogni forma e con ogni mezzo. / Every part of this catalogue - photos included - is Euro-Fer's property. All forms of copying are strictly prohibited.



sezione ferro iron section	tipo ferro iron type	codice code	interasse centre distance	nr. fori nr. of holes	tipo fori kind of holes	luce hole to hole	trattamento finishing
■ 14x14	liscio / smooth	08.001	140 mm	14 fori / holes	□ 14x14	126 mm	grezzo / raw
■ 16x16	liscio / smooth	08.002	150 mm	13 fori / holes	□ 16x16	134 mm	grezzo / raw
■ 18x18	liscio / smooth	08.003	160 mm	12 fori / holes	□ 18x18	142 mm	grezzo / raw
■ 20x20	liscio / smooth	08.004	170 mm	11 fori / holes	□ 20x20	150 mm	grezzo / raw
■ 22x22	liscio / smooth	08.005	170 mm	11 fori / holes	□ 22x22	148 mm	grezzo / raw
■ 25x25	liscio / smooth	08.006	180 mm	10 fori / holes	□ 25x25	155 mm	grezzo / raw
■ 12x12	liscio / smooth	08.006.01	120 mm	16 fori / holes	□ 12x12	108 mm	grezzo / raw



■ 14x14	liscio / smooth	08.007	140 mm	14 fori / holes	◇ 14x14 sullo spigolo / on the edge	120 mm	grezzo / raw
■ 16x16	liscio / smooth	08.008	150 mm	13 fori / holes	◇ 16x16 sullo spigolo / on the edge	127 mm	grezzo / raw
■ 18x18	liscio / smooth	08.009	160 mm	12 fori / holes	◇ 18x18 sullo spigolo / on the edge	135 mm	grezzo / raw
■ 20x20	liscio / smooth	08.010	170 mm	11 fori / holes	◇ 20x20 sullo spigolo / on the edge	142 mm	grezzo / raw
■ 22x22	liscio / smooth	08.011	170 mm	11 fori / holes	◇ 22x22 sullo spigolo / on the edge	139 mm	grezzo / raw
■ 25x25	liscio / smooth	08.012	180 mm	10 fori / holes	◇ 25x25 sullo spigolo / on the edge	145 mm	grezzo / raw



■ 14x14	liscio / smooth	08.013	140 mm	14 fori / holes	◇ 14x14	120 mm	grezzo / raw
■ 16x16	liscio / smooth	08.014	150 mm	13 fori / holes	◇ 16x16	127 mm	grezzo / raw
■ 18x18	liscio / smooth	08.015	160 mm	12 fori / holes	◇ 18x18	135 mm	grezzo / raw
■ 20x20	liscio / smooth	08.016	170 mm	11 fori / holes	◇ 20x20	142 mm	grezzo / raw
■ 22x22	liscio / smooth	08.017	170 mm	11 fori / holes	◇ 22x22	139 mm	grezzo / raw
■ 25x25	liscio / smooth	08.018	180 mm	10 fori / holes	◇ 25x25	145 mm	grezzo / raw



Ø 14	liscio / smooth	08.019	140 mm	14 fori / holes	θ 14x26 mm ovale / oval		grezzo / raw
Ø 16	liscio / smooth	08.020	150 mm	13 fori / holes	θ 16x28 mm ovale / oval		grezzo / raw
Ø 18	liscio / smooth	08.021	160 mm	12 fori / holes	θ 18x30 mm ovale / oval		grezzo / raw
Ø 20	liscio / smooth	08.022	170 mm	11 fori / holes	θ 20x33 mm ovale / oval		grezzo / raw



Ø 14	liscio / smooth	08.023	140 mm	14 fori / holes	Ø 14	126 mm	grezzo / raw
Ø 16	liscio / smooth	08.024	150 mm	13 fori / holes	Ø 16	134 mm	grezzo / raw
Ø 18	liscio / smooth	08.025	160 mm	12 fori / holes	Ø 18	142 mm	grezzo / raw
Ø 20	liscio / smooth	08.026	170 mm	11 fori / holes	Ø 20	150 mm	grezzo / raw
Ø 22	liscio / smooth	08.027	170 mm	11 fori / holes	Ø 22	148 mm	grezzo / raw
Ø 25	liscio / smooth	08.028	180 mm	10 fori / holes	Ø 25	155 mm	grezzo / raw
Ø 30	liscio / smooth	08.029	200 mm	9 fori / holes	Ø 30	170 mm	grezzo / raw
Ø 12	liscio / smooth	08.029.01	120 mm	16 fori / holes	Ø 12	108 mm	grezzo / raw



sezione ferro iron section	tipo ferro iron type	codice code	interasse centre distance	nr. fori nr. of holes	tipo fori kind of holes	luce hole to hole	trattamento finishing
■ 14x14	liscio / smooth	08.106	140 mm	14 fori / holes	□ 24x15 rettangolo / rectangular		grezzo / raw
■ 16x16	liscio / smooth	08.107	150 mm	13 fori / holes	□ 30x17 rettangolo / rectangular		grezzo / raw
■ 18x18	liscio / smooth	08.108	160 mm	12 fori / holes	□ 31x19 rettangolo / rectangular		grezzo / raw
■ 20x20	liscio / smooth	08.109	170 mm	11 fori / holes	□ 33x21 rettangolo / rectangular		grezzo / raw



Ø 14	corteccia / bark	08.109.01	140 mm	14 fori / holes	Ø 14	126 mm	grezzo / raw
Ø 16	corteccia / bark	08.109.02	150 mm	13 fori / holes	Ø 16	134 mm	grezzo / raw
Ø 18	corteccia / bark	08.109.03	160 mm	12 fori / holes	Ø 18	142 mm	grezzo / raw
Ø 20	corteccia / bark	08.109.04	170 mm	11 fori / holes	Ø 20	150 mm	grezzo / raw
Ø 22	corteccia / bark	08.109.05	170 mm	11 fori / holes	Ø 22	148 mm	grezzo / raw



■ 12x12	martellato / hammered	08.110	120 mm	16 fori / holes	□ 12x12	108 mm	grezzo / raw
■ 14x14	martellato / hammered	08.111	140 mm	14 fori / holes	□ 14x14	126 mm	grezzo / raw
■ 16x16	martellato / hammered	08.112	150 mm	13 fori / holes	□ 16x16	134 mm	grezzo / raw
■ 18x18	martellato / hammered	08.113	160 mm	12 fori / holes	□ 18x18	142 mm	grezzo / raw
■ 20x20	martellato / hammered	08.114	170 mm	11 fori / holes	□ 20x20	150 mm	grezzo / raw



■ 14x14	corteccia / bark	08.114.01	140 mm	14 fori / holes	□ 14x14	126 mm	grezzo / raw
■ 16x16	corteccia / bark	08.114.02	150 mm	13 fori / holes	□ 16x16	134 mm	grezzo / raw



■ 14x14	corteccia / bark	08.114.10	140 mm	14 fori / holes	◇14x14	120 mm	grezzo / raw
■ 16x16	corteccia / bark	08.114.11	150 mm	13 fori / holes	◇16x16	127 mm	grezzo / raw



■ 14x14	martellato / hammered	08.114.20	140 mm	14 fori / holes	◇14x14 sullo spigolo / on the edge	120 mm	grezzo / raw
■ 16x16	martellato / hammered	08.114.21	150 mm	13 fori / holes	◇16x16 sullo spigolo / on the edge	127 mm	grezzo / raw



■ 12x12	in spigolo / edged	08.114.30	120 mm	16 fori / holes	□ 12x12	108 mm	grezzo / raw
■ 14x14	in spigolo / edged	08.114.31	140 mm	14 fori / holes	□ 14x14	126 mm	grezzo / raw
■ 16x16	in spigolo / edged	08.114.32	150 mm	13 fori / holes	□ 16x16	134 mm	grezzo / raw
■ 18x18	in spigolo / edged	08.114.33	160 mm	12 fori / holes	□ 18x18	142 mm	grezzo / raw



Ø 14	liscio / smooth	08.115	125 mm	15 fori / holes	Ø 14	111 mm	grezzo / raw
Ø 14	liscio / smooth	08.115.01	130 mm	14 fori / holes	Ø 14	116 mm	grezzo / raw
Ø 16	liscio / smooth	08.116	125 mm	15 fori / holes	Ø 16	109 mm	grezzo / raw
Ø 16	liscio / smooth	08.116.01	160 mm	12 fori / holes	Ø 16	144 mm	grezzo / raw
Ø 18	liscio / smooth	08.117	128 mm	14 fori / holes	Ø 18	110 mm	grezzo / raw
Ø 20	liscio / smooth	08.118	130 mm	13 fori / holes	Ø 20	110 mm	grezzo / raw



sezione ferro iron section	tipo ferro iron type	codice code	interasse centre distance	nr. fori nr. of holes	tipo fori kind of holes	luce hole to hole	trattamento finishing
■ 14x14	liscio / smooth	08.119	125 mm	15 fori / holes	□ 14x14	111 mm	grezzo / raw
■ 14x14	liscio / smooth	08.119.01	125 mm	14 fori / holes	□ 14x14	111 mm.	grezzo / raw
■ 16x16	liscio / smooth	08.120	125 mm	15 fori / holes	□ 16x16	109 mm	grezzo / raw
■ 16x16	liscio / smooth	08.120.01	135 mm	14 fori / holes	□ 16x16	119 mm	grezzo / raw
■ 18x18	liscio / smooth	08.121	128 mm	14 fori / holes	□ 18x18	110 mm	grezzo / raw
■ 20x20	liscio / smooth	08.122	130 mm	13 fori / holes	□ 20x20	110 mm	grezzo / raw



■ 14x14	liscio / smooth	08.123	128 mm	14 fori / holes	◇ 14x14 sullo spigolo / on the edge	108 mm	grezzo / raw
■ 16x16	liscio / smooth	08.124	130 mm	14 fori / holes	◇ 16x16 sullo spigolo / on the edge	107 mm	grezzo / raw
■ 18x18	liscio / smooth	08.125	132 mm	14 fori / holes	◇ 18x18 sullo spigolo / on the edge	107 mm	grezzo / raw
■ 20x20	liscio / smooth	08.126	134 mm	13 fori / holes	◇ 20x20 sullo spigolo / on the edge	106 mm	grezzo / raw



■ 14x14	liscio / smooth	08.127	128 mm	14 fori / holes	◇ 14x14	108 mm	grezzo / raw
■ 14x14	liscio / smooth	08.127.01	135 mm	14 fori / holes	◇ 14x14	115 mm	grezzo / raw
■ 16x16	liscio / smooth	08.128	130 mm	14 fori / holes	◇ 16x16	107 mm	grezzo / raw
■ 16x16	liscio / smooth	08.128.01	135 mm	14 fori / holes	◇ 16x16	112 mm	grezzo / raw
■ 16x16	liscio / smooth	08.128.02	125 mm	15 fori / holes	◇ 16x16	102 mm	grezzo / raw
■ 18x18	liscio / smooth	08.129	132 mm	14 fori / holes	◇ 18x18	107 mm	grezzo / raw
■ 18x18	liscio / smooth	08.129.01	135 mm	14 fori / holes	◇ 18x18	110 mm	grezzo / raw
■ 20x20	liscio / smooth	08.130	135 mm	13 fori / holes	◇ 20x20	107 mm	grezzo / raw



Ø 14	corteccia / bark	08.130.01	125 mm	15 fori / holes	Ø 14	111 mm	grezzo / raw
Ø 16	corteccia / bark	08.130.02	125 mm	15 fori / holes	Ø 16	109 mm	grezzo / raw
Ø 18	corteccia / bark	08.130.03	128 mm	14 fori / holes	Ø 18	110 mm	grezzo / raw



■ 16x16	liscio / smooth	08.131	125 mm	15 fori / holes	□ 14x14	111 mm	grezzo / raw
---------	-----------------	---------------	--------	-----------------	---------	--------	--------------



Ø 16	liscio / smooth	08.132	125 mm	15 fori / holes	Ø 14	111 mm	grezzo / raw
------	-----------------	---------------	--------	-----------------	------	--------	--------------



BARRE FORATE SABBIAIE / SANDBLASTED HOLED BARS

sezione ferro iron section	tipo ferro iron type	codice code	interasse centre distance	nr. fori nr. of holes	tipo fori kind of holes	luce hole to hole	trattamento finishing
■ 12x12	liscio / smooth	08.133	120 mm	16 fori / holes	□ 12x12	108 mm	sabbiato / sandblasted
■ 14x14	liscio / smooth	08.134	140 mm	14 fori / holes	□ 14x14	126 mm	sabbiato / sandblasted
■ 16x16	liscio / smooth	08.135	150 mm	13 fori / holes	□ 16x16	134 mm	sabbiato / sandblasted
■ 18x18	liscio / smooth	08.136	160 mm	12 fori / holes	□ 18x18	142 mm	sabbiato / sandblasted
■ 20x20	liscio / smooth	08.137	170 mm	11 fori / holes	□ 20x20	150 mm	sabbiato / sandblasted
■ 22x22	liscio / smooth	08.138	170 mm	11 fori / holes	□ 22x22	148 mm	sabbiato / sandblasted
■ 25x25	liscio / smooth	08.139	180 mm	10 fori / holes	□ 25x25	155 mm	sabbiato / sandblasted



BARRE FORATE SABBIAIE / SANDBLASTED HOLED BARS

■ 14x14	liscio / smooth	08.140	140 mm	14 fori / holes	◇ 14x14 sullo spigolo / on the edge	120 mm	sabbiato / sandblasted
■ 16x16	liscio / smooth	08.141	150 mm	13 fori / holes	◇ 16x16 sullo spigolo / on the edge	127 mm	sabbiato / sandblasted
■ 18x18	liscio / smooth	08.142	160 mm	12 fori / holes	◇ 18x18 sullo spigolo / on the edge	135 mm	sabbiato / sandblasted
■ 20x20	liscio / smooth	08.143	170 mm	11 fori / holes	◇ 20x20 sullo spigolo / on the edge	142 mm	sabbiato / sandblasted
■ 22x22	liscio / smooth	08.144	170 mm	11 fori / holes	◇ 22x22 sullo spigolo / on the edge	139 mm	sabbiato / sandblasted
■ 25x25	liscio / smooth	08.145	180 mm	10 fori / holes	◇ 25x25 sullo spigolo / on the edge	145 mm	sabbiato / sandblasted



BARRE FORATE SABBIAIE / SANDBLASTED HOLED BARS

■ 14x14	liscio / smooth	08.146	140 mm	14 fori / holes	◇ 14x14	120 mm	sabbiato / sandblasted
■ 16x16	liscio / smooth	08.147	150 mm	13 fori / holes	◇ 16x16	127 mm	sabbiato / sandblasted
■ 18x18	liscio / smooth	08.148	160 mm	12 fori / holes	◇ 18x18	135 mm	sabbiato / sandblasted
■ 20x20	liscio / smooth	08.149	170 mm	11 fori / holes	◇ 20x20	142 mm	sabbiato / sandblasted
■ 22x22	liscio / smooth	08.150	170 mm	11 fori / holes	◇ 22x22	139 mm	sabbiato / sandblasted
■ 25x25	liscio / smooth	08.151	180 mm	10 fori / holes	◇ 25x25	145 mm	sabbiato / sandblasted



BARRE FORATE SABBIAIE / SANDBLASTED HOLED BARS

Ø 14	liscio / smooth	08.152	140 mm	14 fori / holes	⊖ 14x26 mm ovale / oval		sabbiato / sandblasted
Ø 16	liscio / smooth	08.153	150 mm	13 fori / holes	⊖ 16x28 mm ovale / oval		sabbiato / sandblasted
Ø 18	liscio / smooth	08.154	160 mm	12 fori / holes	⊖ 18x30 mm ovale / oval		sabbiato / sandblasted
Ø 20	liscio / smooth	08.155	170 mm	11 fori / holes	⊖ 20x33 mm ovale / oval		sabbiato / sandblasted

BARRE FORATE SABBIASTE HOLED BARS SAND - BLASTED



BARRE FORATE SABBIASTE / SANDBLASTED HOLED BARS

sezione ferro iron section	tipo ferro iron type	codice code	interasse centre distance	nr. fori nr. of holes	tipo fori kind of holes	luce hole to hole	trattamento finishing
Ø 12	liscio / smooth	08.156	120 mm	16 fori / holes	Ø 12	108 mm	sabbiato / sandblasted
Ø 14	liscio / smooth	08.157	140 mm	14 fori / holes	Ø 14	126 mm	sabbiato / sandblasted
Ø 16	liscio / smooth	08.158	150 mm	13 fori / holes	Ø 16	134 mm	sabbiato / sandblasted
Ø 18	liscio / smooth	08.159	160 mm	12 fori / holes	Ø 18	142 mm	sabbiato / sandblasted
Ø 20	liscio / smooth	08.160	170 mm	11 fori / holes	Ø 20	150 mm	sabbiato / sandblasted
Ø 22	liscio / smooth	08.161	170 mm	11 fori / holes	Ø 22	148 mm	sabbiato / sandblasted
Ø 25	liscio / smooth	08.162	180 mm	10 fori / holes	Ø 25	155 mm	sabbiato / sandblasted
Ø 30	liscio / smooth	08.163	200 mm	9 fori / holes	Ø 30	170 mm	sabbiato / sandblasted
Ø 14	liscio / smooth	08.164	125 mm	15 fori / holes	Ø 14	111 mm	sabbiato / sandblasted
Ø 14	liscio / smooth	08.164.01	130 mm	14 fori / holes	Ø 14	116 mm	sabbiato / sandblasted
Ø 16	liscio / smooth	08.165	125 mm	15 fori / holes	Ø 16	109 mm	sabbiato / sandblasted
Ø 16	liscio / smooth	08.165.01	160 mm	12 fori / holes	Ø 16	144 mm	sabbiato / sandblasted
Ø 18	liscio / smooth	08.166	128 mm	14 fori / holes	Ø 18	110 mm	sabbiato / sandblasted
Ø 20	liscio / smooth	08.167	130 mm	13 fori / holes	Ø 20	110 mm	sabbiato / sandblasted



BARRE FORATE SABBIASTE / SANDBLASTED HOLED BARS

■ 14x14	liscio / smooth	08.168	125 mm	15 fori / holes	□ 14x14	111 mm	sabbiato / sandblasted
■ 14x14	liscio / smooth	08.168.01	125 mm	14 fori / holes	□ 14x14	111 mm.	sabbiato / sandblasted
■ 16x16	liscio / smooth	08.169	125 mm	15 fori / holes	□ 16x16	109 mm	sabbiato / sandblasted
■ 16x16	liscio / smooth	08.169.01	135 mm	14 fori / holes	□ 16x16	119 mm	sabbiato / sandblasted
■ 18x18	liscio / smooth	08.170	128 mm	14 fori / holes	□ 18x18	110 mm	sabbiato / sandblasted
■ 20x20	liscio / smooth	08.171	130 mm	13 fori / holes	□ 20x20	110 mm	sabbiato / sandblasted



BARRE FORATE SABBIASTE / SANDBLASTED HOLED BARS

■ 14x14	liscio / smooth	08.172	128 mm	14 fori / holes	◇14x14 sullo spigolo / on the edge	108 mm	sabbiato / sandblasted
■ 16x16	liscio / smooth	08.173	130 mm	14 fori / holes	◇16x16 sullo spigolo / on the edge	107 mm	sabbiato / sandblasted
■ 18x18	liscio / smooth	08.174	132 mm	14 fori / holes	◇18x18 sullo spigolo / on the edge	107 mm	sabbiato / sandblasted
■ 20x20	liscio / smooth	08.175	134 mm	13 fori / holes	◇20x20 sullo spigolo / on the edge	106 mm	sabbiato / sandblasted



BARRE FORATE SABBIAIE / SANDBLASTED HOLED BARS

sezione ferro iron section	tipo ferro iron type	codice code	interasse centre distance	nr. fori nr. of holes	tipo fori kind of holes	luce hole to hole	trattamento finishing
■ 14x14	liscio / smooth	08.176	128 mm	14 fori / holes	◇14x14	108 mm	sabbiato / sandblasted
■ 14x14	liscio / smooth	08.176.01	135 mm	14 fori / holes	◇14x14	115 mm	sabbiato / sandblasted
■ 16x16	liscio / smooth	08.177	130 mm	14 fori / holes	◇16x16	107 mm	sabbiato / sandblasted
■ 16x16	liscio / smooth	08.177.01	135 mm	14 fori / holes	◇16x16	112 mm	sabbiato / sandblasted
■ 16x16	liscio / smooth	08.177.02	125 mm	15 fori / holes	◇16x16	102 mm	sabbiato / sandblasted
■ 18x18	liscio / smooth	08.178	132 mm	14 fori / holes	◇18x18	107 mm	sabbiato / sandblasted
■ 18x18	liscio / smooth	08.178.01	135 mm	14 fori / holes	◇18x18	110 mm	sabbiato / sandblasted
■ 20x20	liscio / smooth	08.179	135 mm	13 fori / holes	◇20x20	107 mm	sabbiato / sandblasted



BARRE FORATE SABBIAIE / SANDBLASTED HOLED BARS

■ 16x16	liscio / smooth	08.180	125 mm	15 fori / holes	□ 14x14	111 mm	sabbiato / sandblasted
---------	-----------------	---------------	--------	-----------------	---------	--------	------------------------



BARRE FORATE SABBIAIE / SANDBLASTED HOLED BARS

Ø 16	liscio / smooth	08.181	125 mm	15 fori / holes	Ø 14	111 mm	sabbiato / sandblasted
------	-----------------	---------------	--------	-----------------	------	--------	------------------------



SECRETA

FENCING SYSTEM



SECRETA - FENCING SYSTEM

SECRETA è un elegante sistema di recinzione a doghe orizzontali, dal design raffinato e moderno, che mira a garantire una maggiore privacy della vostra proprietà. È realizzata in acciaio prezincato a caldo Sendzimir verniciato a polveri, processo che esalta l'eleganza e garantisce durata nel tempo.

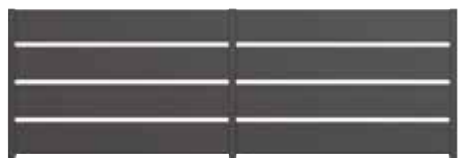

ART. SEC10DOGHE

- Altezza finita 1000 mm
- 4 doghe

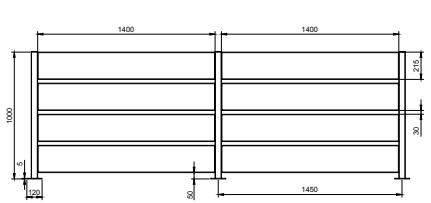

ART. SEC12DOGHE

- Altezza finita 1245 mm
- 5 doghe

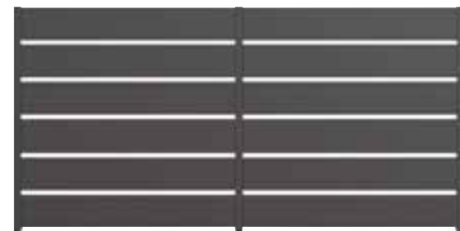
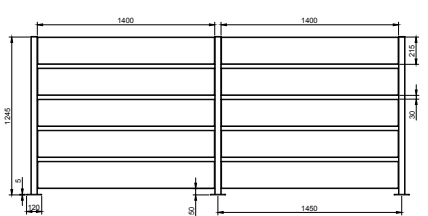

ART. SEC15DOGHE

- Altezza finita 1490 mm
- 6 doghe

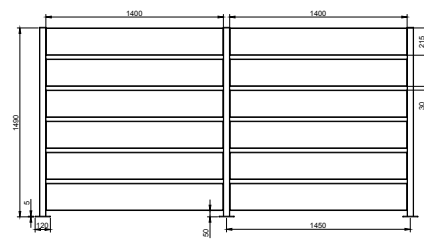

KIT DOGHE

Kit composto da doghe orizzontali in lamiera prezincata a caldo Sendzimir e verniciata a polveri, fornito in scatola e comprensivo di viti torx in acciaio inox e inserto di sicurezza antieffrazione.

PIANTANE

Piantane in tubo 50x50 mm di acciaio prezincato a caldo Sendzimir verniciate a polveri, a tassellare o cementare, dotate di rivetto filettato in acciaio Inox preassemblato per il fissaggio della doga.

Kit recinzioni	Tipologia	Codice (a TASSELLARE)	Codice (a CEMENTARE)
SEC10DOGHE	piantana di partenza	SEC10TP	SEC10CP
	piantana intermedia	SEC10TI	SEC10CI
	piantana per angolo 90°	SEC10TA	SEC10CA
SEC12DOGHE	piantana di partenza	SEC12TP	SEC12CP
	piantana intermedia	SEC12TI	SEC12CI
	piantana per angolo 90°	SEC12TA	SEC12CA
SEC15DOGHE	piantana di partenza	SEC15TP	SEC15CP
	piantana intermedia	SEC15TI	SEC15CI
	piantana per angolo 90°	SEC15TA	SEC15CA



Confezione in cartone compatta e facile da trasportare!

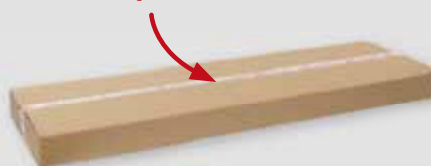

La fattibilità della realizzazione del decoro va verificata in base a dimensioni e spessori della lastra. / The feasibility of making certain decorations may depend on plate size and thickness.

Tutte le parti di questo catalogo - foto comprese - sono di proprietà Euro-Fer. La riproduzione, anche parziale, è vietata in ogni forma e con ogni mezzo. / Every part of this catalogue - photos included - is Euro-Fer's property. All forms of copying are strictly prohibited.



LASERFER

BY EUROFER

LASERFER TRASFORMA LE IDEE IN TAGLI DI LUCE.

Per migliorare la capacità di essere sempre al servizio del cliente, EUROFER ha deciso di ampliare la propria gamma con gli articoli tagliati al laser e con una tecnologia che permetterà ai disegni di prendere forma.

Oltre agli elementi tradizionali quali piastre, terminali ed ornamenti, sono proposti pannelli per recinzioni, per cancelli, per portali o per decoro.

Accanto alle nuove tematiche proposte dai Designers in questo catalogo, sulle superfici come il ferro, l'acciaio inossidabile e il corten si possono realizzare figure o soggetti a piacere. Il ferro della lastra può essere zincato o colorato, LASERFER propone quindi un prodotto finito e di sicuro effetto.

LASERFER TURNS IDEAS INTO DESIGNS OF LIGHT.

To improve the capacity of always being about customer service, EUROFER has decided to extend its range with laser-cut products thanks to a technology that will allow drawings to take shape.

Besides traditional elements like plates, frets and ornaments for railings, there are also panels for enclosures, gates, portals or just for pure aesthetic.

Next to Designers' new issues in this catalogue, for what concerns surfaces like iron, stainless steel and corten, it's possible to create new figures or objects as desired.

Sheet iron can be galvanised or coloured, LASERFER proposes a finished product with a huge impact.

- 1** Scegli, nello schema della pagina seguente, i pannelli che vuoi ordinare.
In the pattern in the following page, choose the panels corresponding to your gate /fencing.

ESEMPIO / EXAMPLE: **CANCELLO PRINCIPALE E RECINZIONE** / FRONT GATE AND FENCING

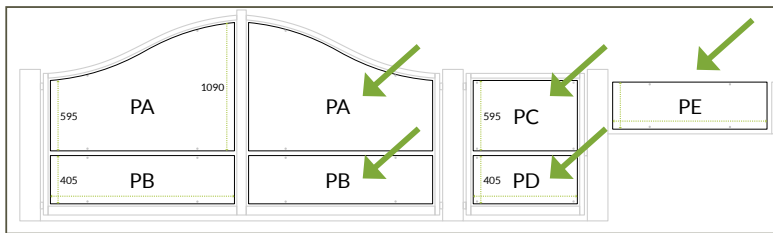

CANCELLO PRINCIPALE:
PANNELLO PA DESTRO E SINISTRO
PANNELLO PB DESTRO E SINISTRO

FRONT GATE:
PANEL PA RIGHT AND LEFT
PANEL PB RIGHT AND LEFT

CANCELLETTO PEDONALE:
PANNELLO PC - PANNELLO PD
PEDESTRIAN GATE:
PANEL PC - PANEL PD

RECINZIONE: PANNELLO PE
FENCING: PANEL PE

- 2** Scegli poi il decoro nelle pagine seguenti.
Select the pattern in the following pages.

ESEMPIO / EXAMPLE: **PARALLELOS LINE 07 - 09 - 10**

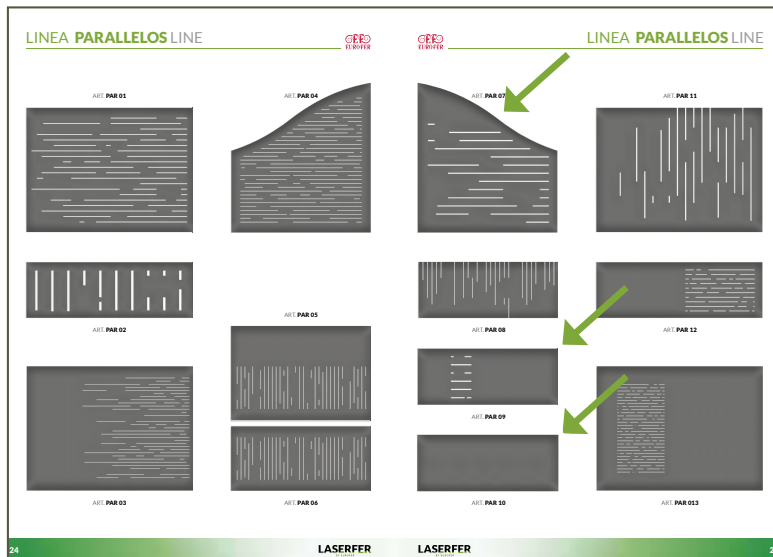

- 3** Indica poi:
TIPO DI PANNELLO SCELTO, DECORO E QUANTITÀ
Please indicate: KIND OF PANEL, DECORATION AND QUANTITY

ESEMPIO / EXAMPLE:

PA destro / right	PARALLELOS LINE 07	n° 1
PA sinistro / left	PARALLELOS LINE 07	n° 1
PB destro / right	PARALLELOS LINE 10	n° 1
PB sinistro / left	PARALLELOS LINE 10	n° 1
PC	PARALLELOS LINE 07	n° 1
PD	PARALLELOS LINE 10	n° 1
PE	PARALLELOS LINE 09	n° 2

- 4** Completa il tuo ordine indicando lo spessore della lamiera, il tipo di materiale e la finitura.

Complete your order with: thickness plate, material type and finish.

Ed ecco visualizzato il Vostro ordine/ And now your plan:

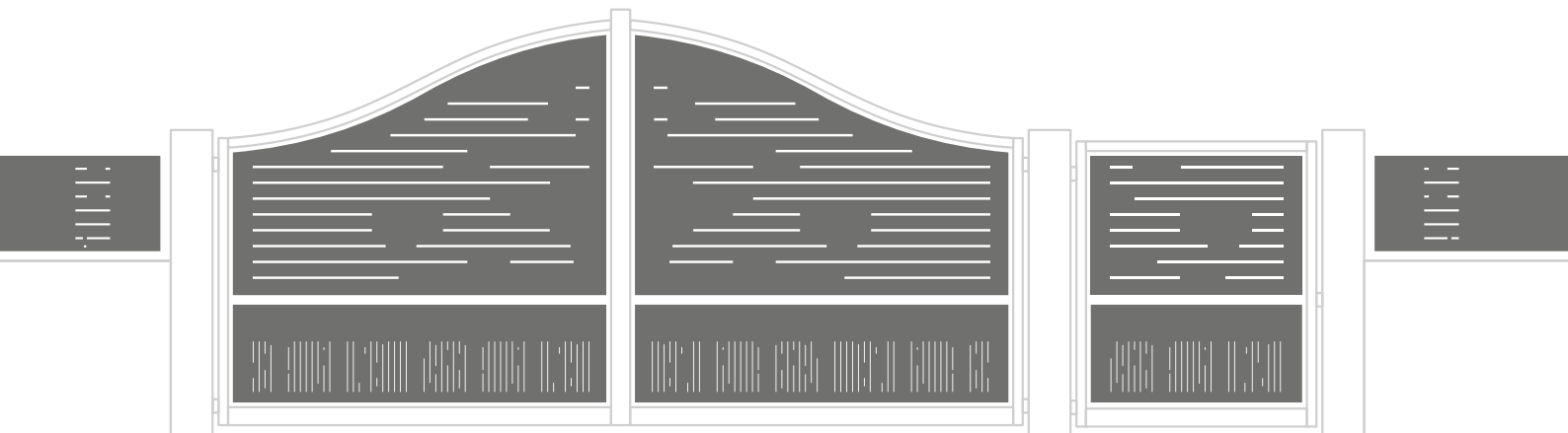

La fattibilità della realizzazione del decoro va verificata in base a dimensioni e spessori della lastra. / The feasibility of making certain decorations may depend on plate size and thickness.

Tutte le parti di questo catalogo - foto comprese - sono di proprietà Euro-Fer. La riproduzione, anche parziale, è vietata in ogni forma e con ogni mezzo. / Every part of this catalogue - photos included - is Euro-Fer's property. All forms of copying are strictly prohibited.

CODICI - DIMENSIONI / CODES - DIMENSIONS

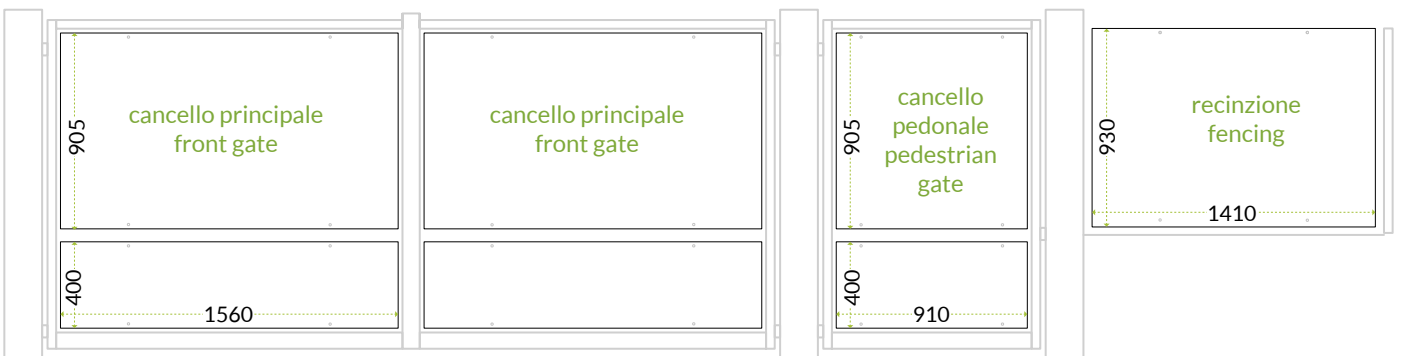
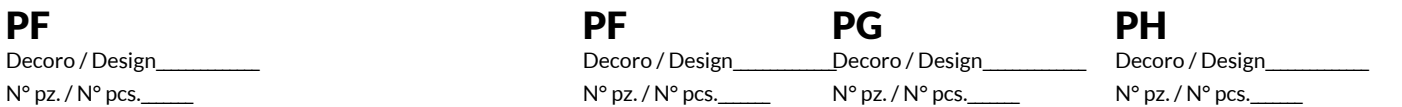
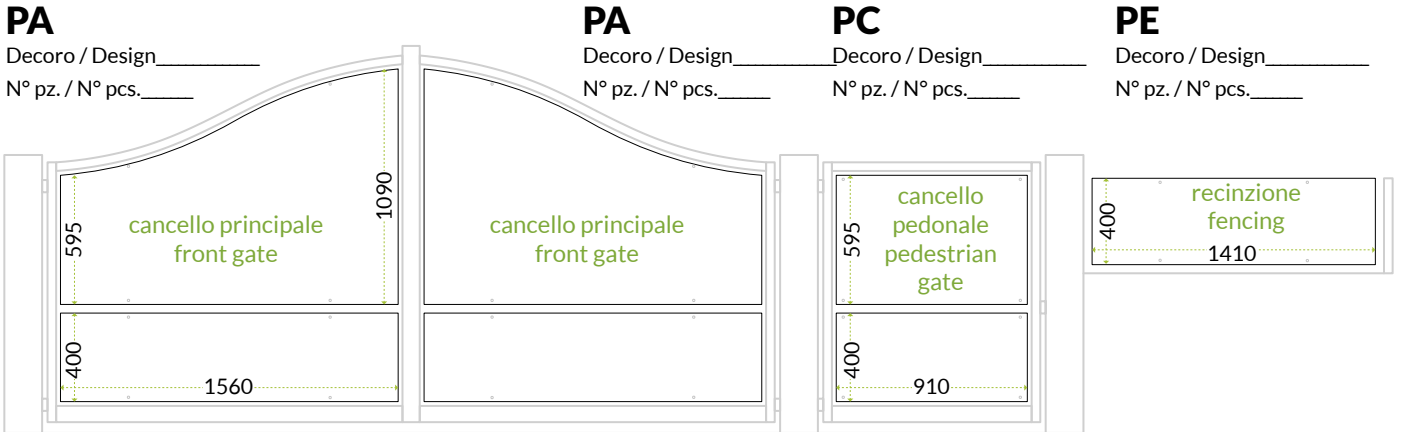

DECORAZIONE / DESIGN



Scegli i decori Laserfer
Choose a Laserfer design

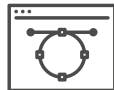

Allega il tuo file .dxf
Send us your .dxf file



Allega il tuo disegno
Send us your sketch

SPESSORI - MATERIALI E FINITURE / THICKNESS - MATERIALS AND FINISHING

Spessore Lamiera
Sheet Thickness

- 20/10
- 25/10
- 30/10
- 40/10
-

Materiale / Material
Finitura / Finishing

- FERRO GREZZO / RAW IRON
- PRE-ZINCATO / GALVANIZED
- PRE-ZINCATO VERNICIATO
PRE-GALVANIZED POWDER COATED

- COR-TEN
- INOX 304
- INOX 316



RAL.....

For specific questions regarding finish, colouring, or technical topics, please contact your local sales office.

La fattibilità della realizzazione del decoro va verificata in base a dimensioni e spessori della lastra. / The feasibility of making certain decorations may depend on plate size and thickness.

Tutte le parti di questo catalogo - foto comprese - sono di proprietà Euro-Fer. La riproduzione, anche parziale, è vietata in ogni forma e con ogni mezzo. / Every part of this catalogue - photos included - is Euro-Fer's property. All forms of copying are strictly prohibited.

CODICI - DIMENSIONI / CODES - DIMENSIONS

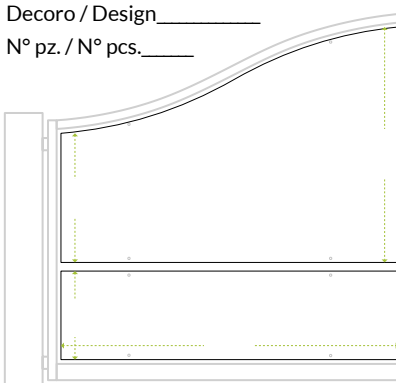
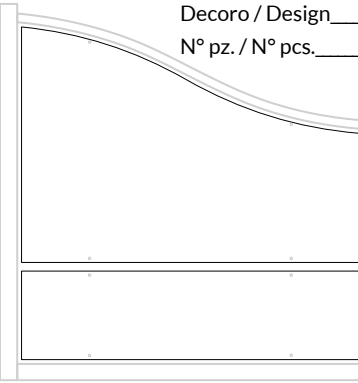
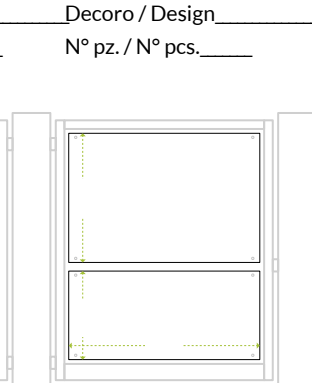
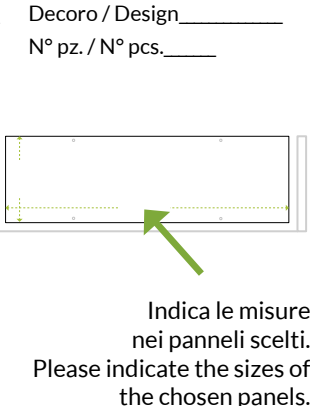
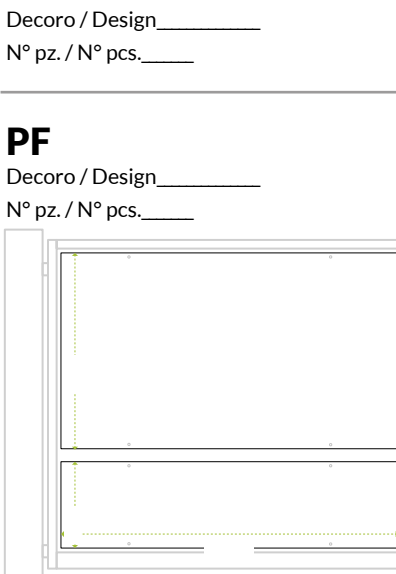
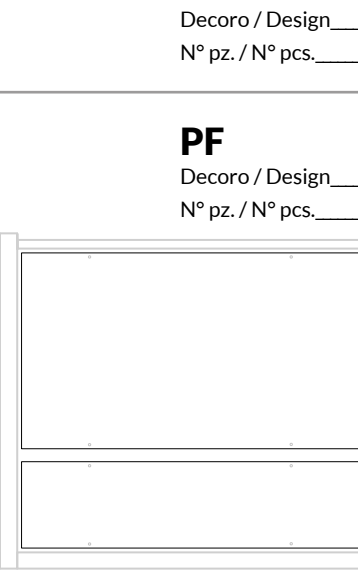
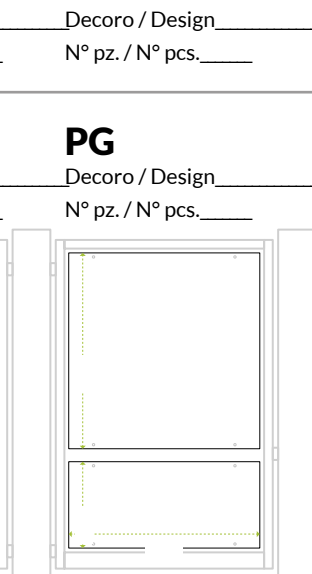
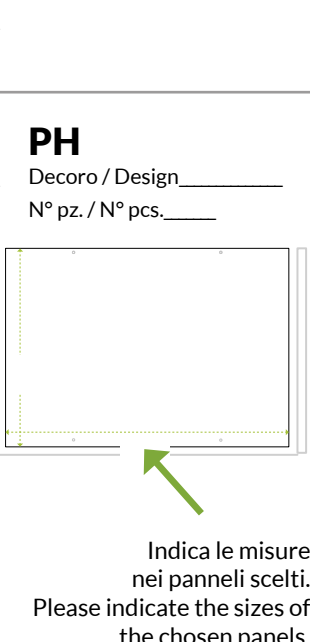
<p>PA Decoro / Design _____ N° pz. / N° pcs. _____</p> 	<p>PA Decoro / Design _____ N° pz. / N° pcs. _____</p> 	<p>PC Decoro / Design _____ N° pz. / N° pcs. _____</p> 	<p>PE Decoro / Design _____ N° pz. / N° pcs. _____</p> 
<p>PB Decoro / Design _____ N° pz. / N° pcs. _____</p> 	<p>PB Decoro / Design _____ N° pz. / N° pcs. _____</p> 	<p>PD Decoro / Design _____ N° pz. / N° pcs. _____</p> 	<p>PH Decoro / Design _____ N° pz. / N° pcs. _____</p> 

DECORAZIONE / DESIGN



- Scegli i decori Laserfer
Choose a Laserfer design



- Allega il tuo file .dxf
Send us your .dxf file



- Allega il tuo disegno
Send us your sketch

SPESSORI - MATERIALI E FINITURE / THICKNESS - MATERIALS AND FINISHING

Spessore Lamiera
Sheet Thickness

- 20/10
 25/10
 30/10
 40/10

Materiale / Material
Finitura / Finishing

- FERRO GREZZO / RAW IRON
 PRE-ZINCATO / GALVANIZED
 PRE-ZINCATO VERNICIATO
PRE-GALVANIZED POWDER COATED

- COR-TEN
 INOX 304
 INOX 316



RAL.....

For specific questions regarding finish, colouring, or technical topics, please contact your local sales office.

La fattibilità della realizzazione del decoro va verificata in base a dimensioni e spessori della lastra. / The feasibility of making certain decorations may depend on plate size and thickness.

Tutte le parti di questo catalogo - foto comprese - sono di proprietà Euro-Fer. La riproduzione, anche parziale, è vietata in ogni forma e con ogni mezzo. / Every part of this catalogue - photos included - is Euro-Fer's property. All forms of copying are strictly prohibited.

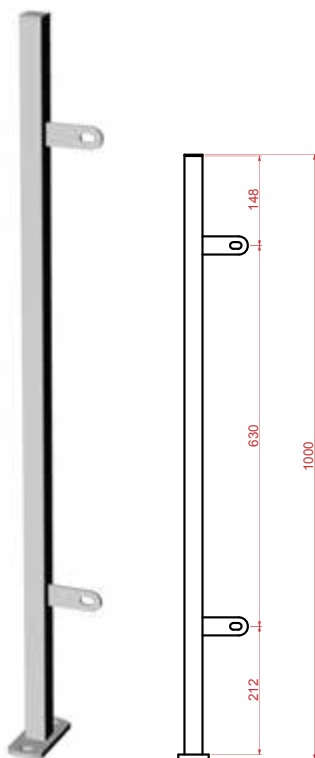

PLP 10 - H 1000 mm

Caposaldo forato con piastra di fissaggio. Comprende 2 viti M10 con dado antifurto. / Drilled newel post with base plates to bolt down to concrete or walls. Includes 2 x M10 Bolts and snap off cone nuts to fix the panel to the post.

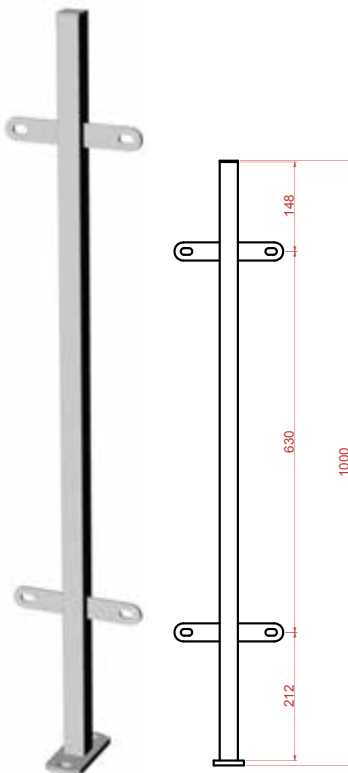

PLM 10 - H 1000 mm

Caposaldo forato con piastra di fissaggio. Comprende 4 viti M10 con dado antifurto. / Drilled newel post with base plates to bolt down to concrete or walls. Includes 4 x M10 Bolts and snap off cone nuts to fix the panel to the post.

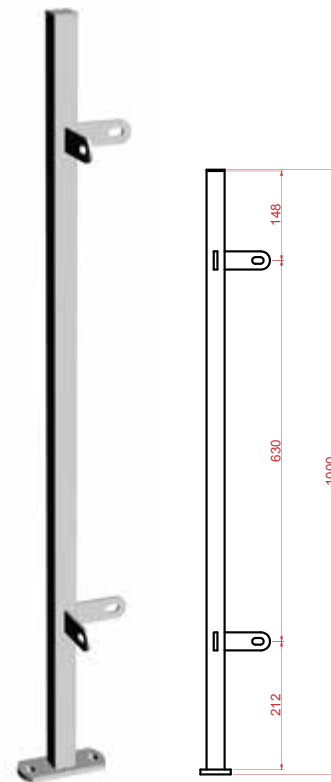

PLC 10 - H 1000 mm

Caposaldo forato con piastra di fissaggio. Comprende 4 viti M10 con dado antifurto. / Drilled newel post with base plates to bolt down to concrete or walls. Includes 4 x M10 Bolts and snap off cone nuts to fix the panel to the post.

Finiture / Finishes

Standard: piantone zincato a caldo / galvanized post

V: piantone zincato a caldo e verniciato / galvanized and powder coated post

G: piantone grezzo / untreated post



KIT-VITI.L

Comprende 4 viti M 10 in ferro zincato con dado antifurto.

Includes 4 x M 10 bolts (galvanized iron) and snap-off cone nuts.

I caposaldi della famiglia Laserfer sono zincati a caldo e vengono forniti con un set di viti M10 (KIT-VITI.L) zincate a freddo complete di dado antifurto per il fissaggio del pannello.

The Laserfer PANELS posts are hot galvanized, and include a set of M10 bolts (KIT-VITI.L) cold galvanized and snap-off cone nuts for fixing the panel.



ART. PAR 01

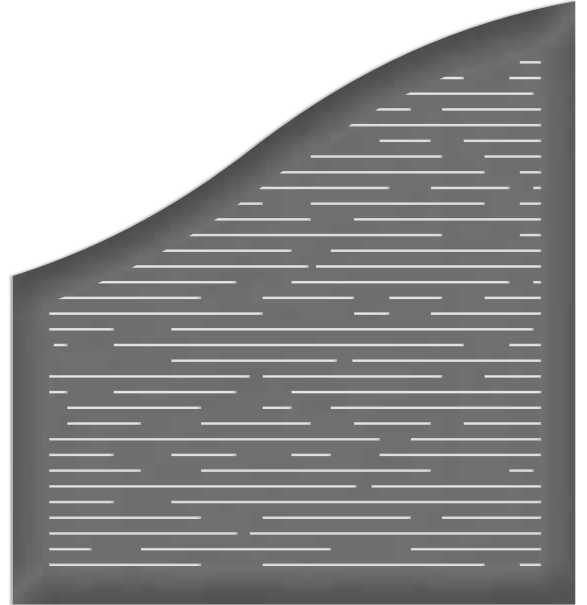

ART. PAR 04



ART. PAR 02

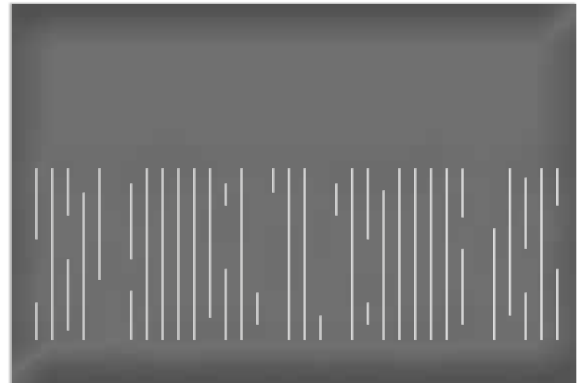

ART. PAR 05

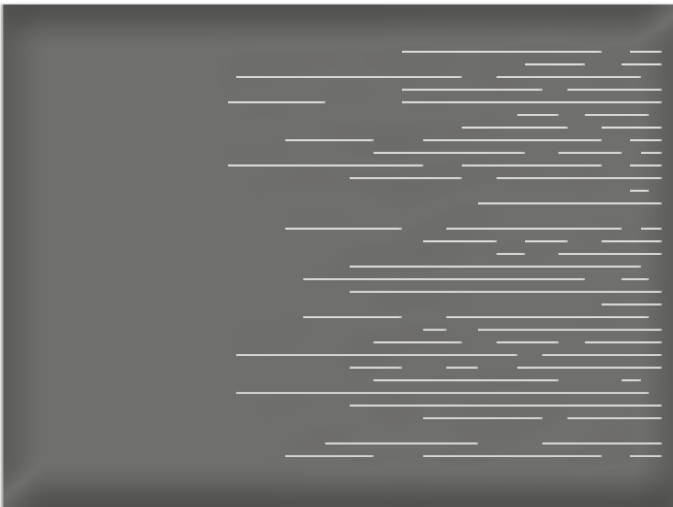

ART. PAR 03

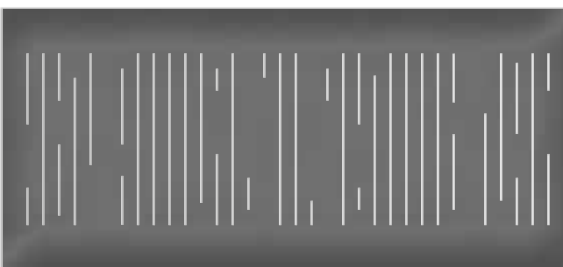

ART. PAR 06



La fattibilità della realizzazione del decoro va verificata in base a dimensioni e spessori della lastra. / The feasibility of making certain decorations may depend on plate size and thickness.

Tutte le parti di questo catalogo - foto comprese - sono di proprietà Euro-Fer. La riproduzione, anche parziale, è vietata in ogni forma e con ogni mezzo. / Every part of this catalogue - photos included - is Euro-Fer's property. All forms of copying are strictly prohibited.



ART. **PAR 07**



ART. **PAR 09**

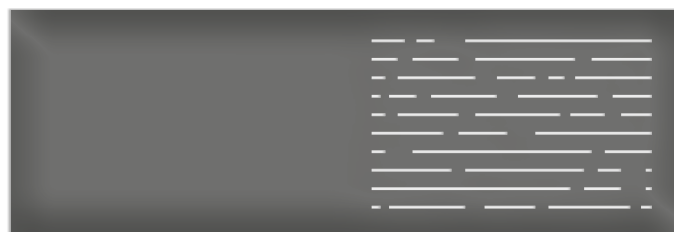

ART. **PAR 12**



ART. **PAR 10**



ART. **PAR 13**



ART. **PAR 11**

La fattibilità della realizzazione del decoro va verificata in base a dimensioni e spessori della lastra. / The feasibility of making certain decorations may depend on plate size and thickness.

Tutte le parti di questo catalogo - foto comprese - sono di proprietà Euro-Fer. La riproduzione, anche parziale, è vietata in ogni forma e con ogni mezzo. / Every part of this catalogue - photos included - is Euro-Fer's property. All forms of copying are strictly prohibited.

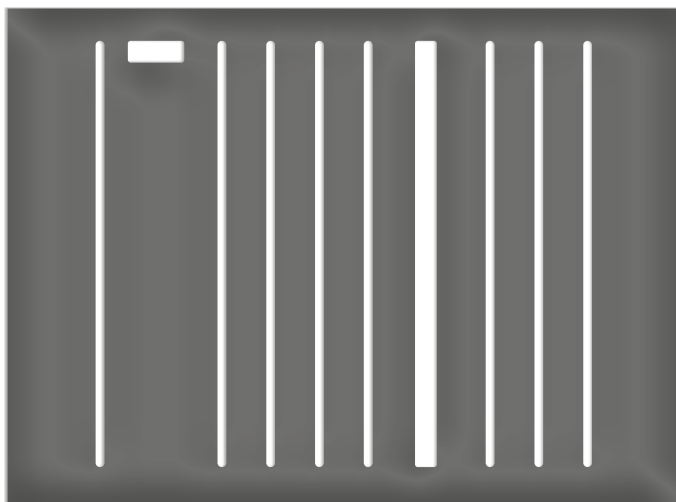

ART. PAR 14



ART. PAR 15

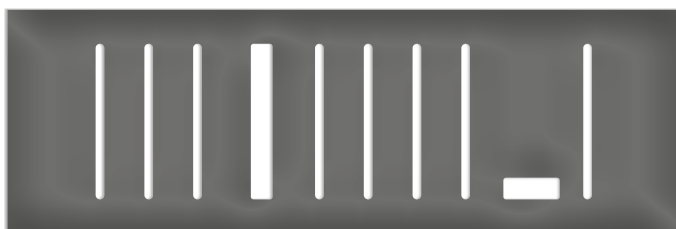

ART. PAR 16

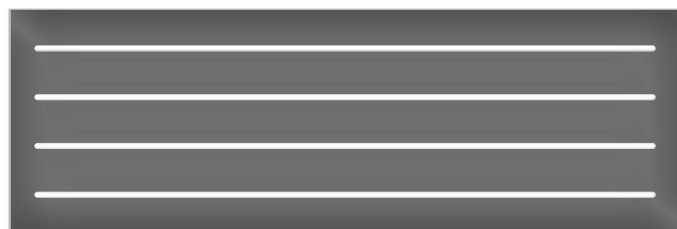

ART. PAR 17

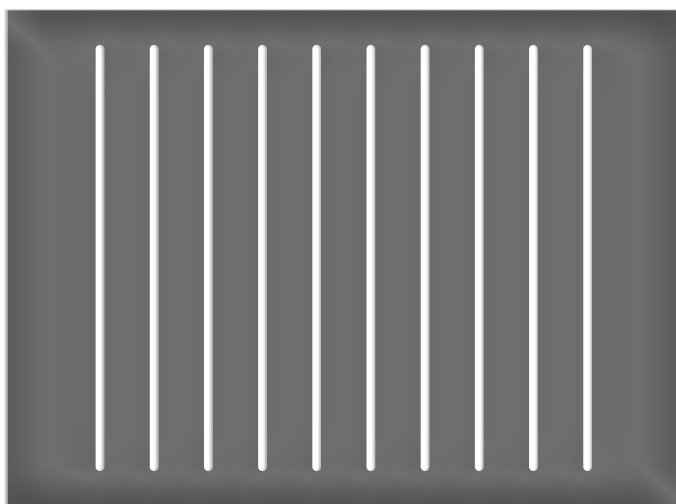

ART. PAR 18

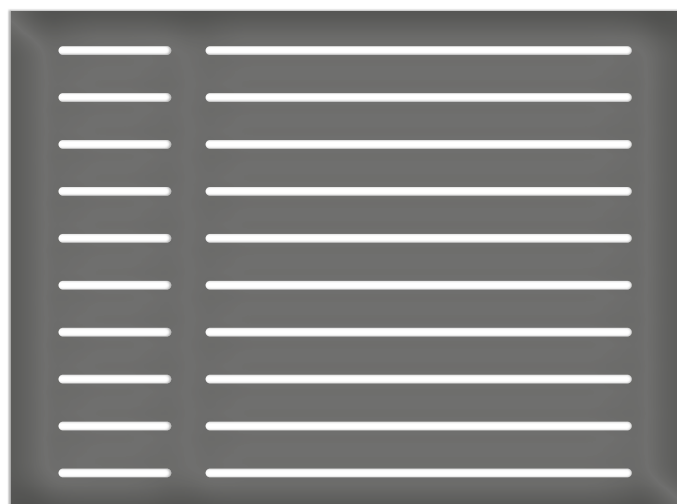

ART. PAR 19

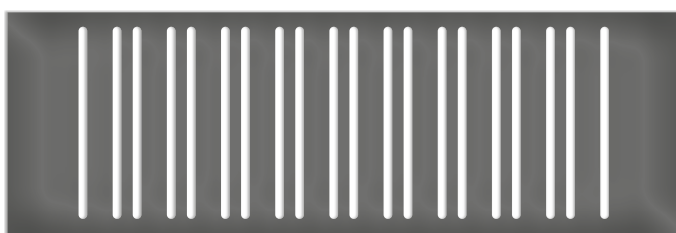

ART. PAR 20



ART. PAR 21

La fattibilità della realizzazione del decoro va verificata in base a dimensioni e spessori della lastra. / The feasibility of making certain decorations may depend on plate size and thickness.

Tutte le parti di questo catalogo - foto comprese - sono di proprietà Euro-Fer. La riproduzione, anche parziale, è vietata in ogni forma e con ogni mezzo. / Every part of this catalogue - photos included - is Euro-Fer's property. All forms of copying are strictly prohibited.

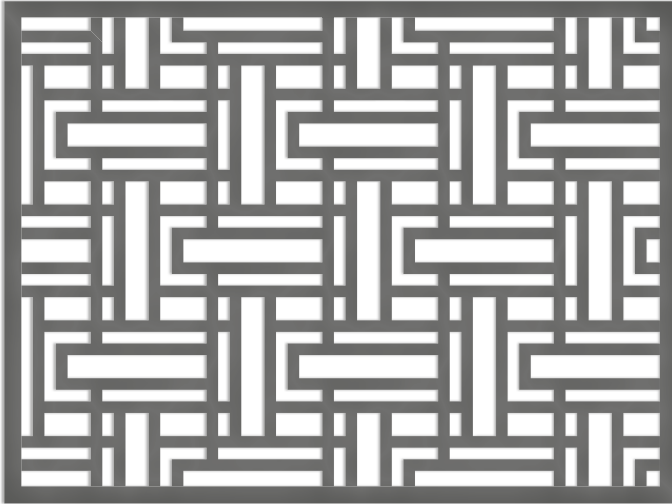

ART. GEO 01

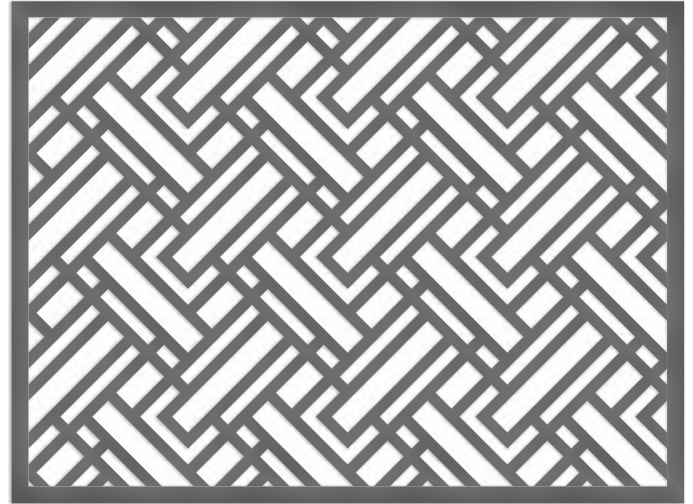

ART. GEO 02

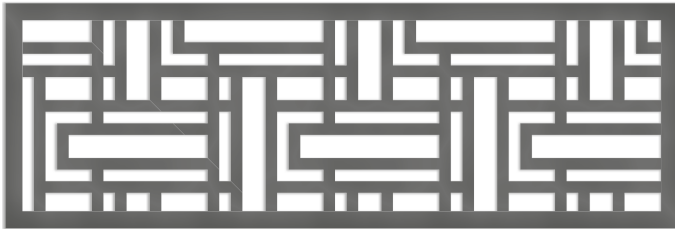

ART. GEO 03

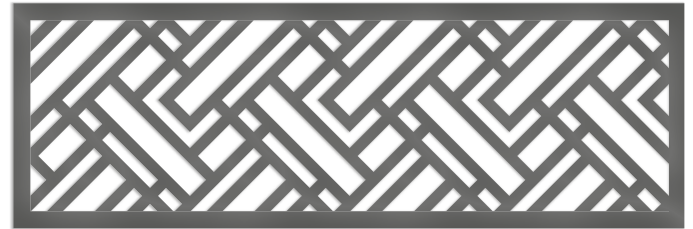

ART. GEO 04

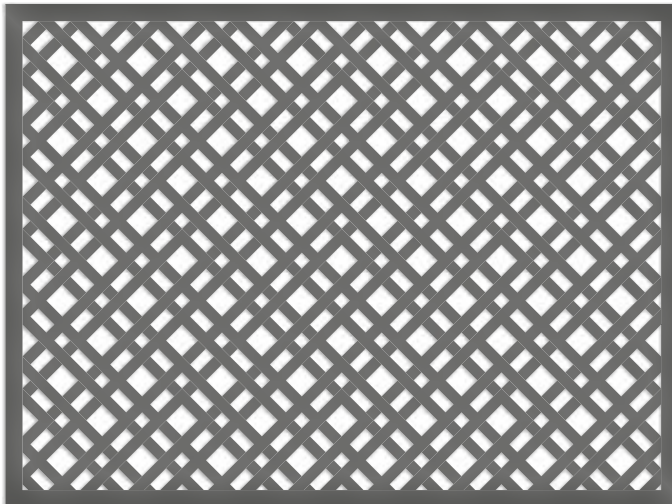

ART. GEO 05

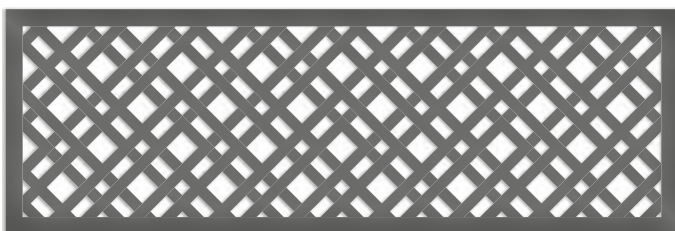

ART. GEO 06



La fattibilità della realizzazione del decoro va verificata in base a dimensioni e spessori della lastra. / The feasibility of making certain decorations may depend on plate size and thickness.

Tutte le parti di questo catalogo - foto comprese - sono di proprietà Euro-Fer. La riproduzione, anche parziale, è vietata in ogni forma e con ogni mezzo. / Every part of this catalogue - photos included - is Euro-Fer's property. All forms of copying are strictly prohibited.

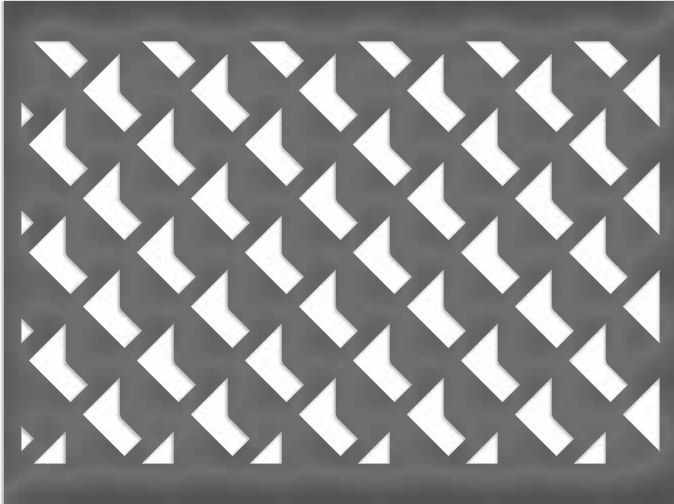

ART. QUA 05

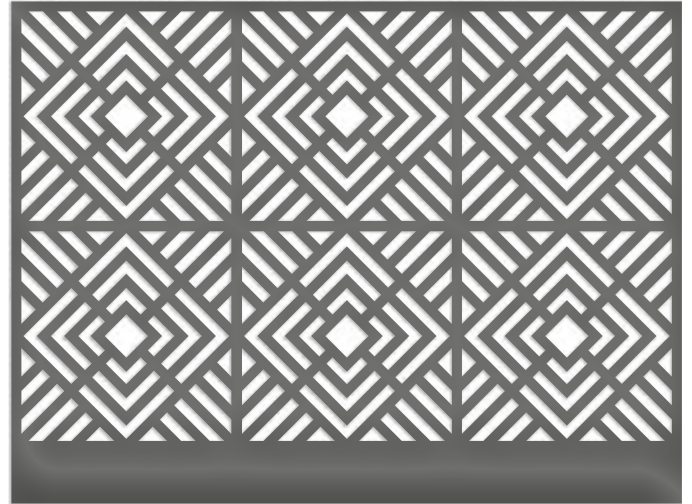

NEW

ART. QUA 07

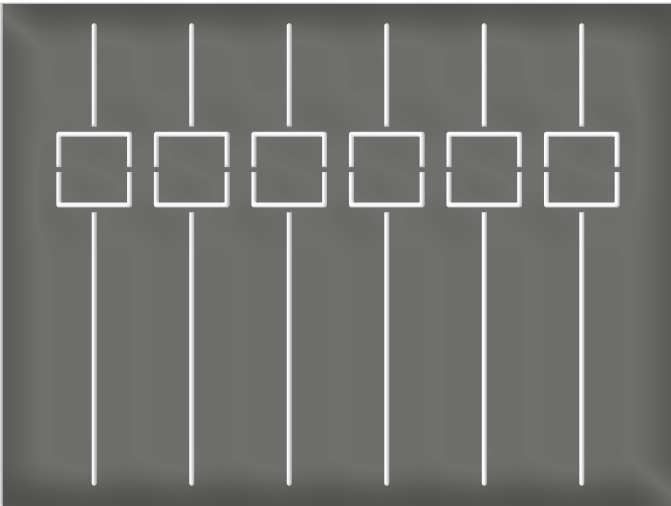

NEW

ART. QUA 08

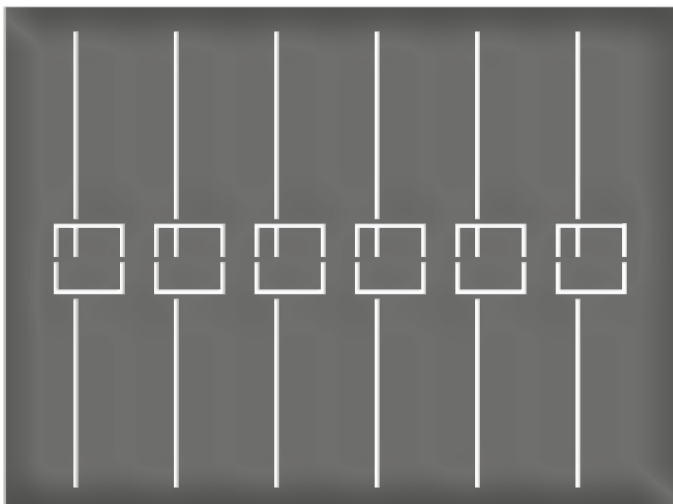

NEW

ART. QUA 09

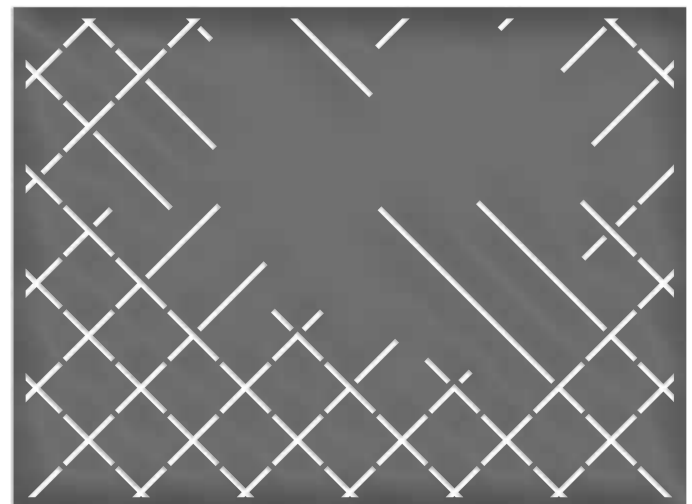

NEW

ART. QUA 10

La fattibilità della realizzazione del decoro va verificata in base a dimensioni e spessori della lastra. / The feasibility of making certain decorations may depend on plate size and thickness.

Tutte le parti di questo catalogo - foto comprese - sono di proprietà Euro-Fer. La riproduzione, anche parziale, è vietata in ogni forma e con ogni mezzo. / Every part of this catalogue - photos included - is Euro-Fer's property. All forms of copying are strictly prohibited.

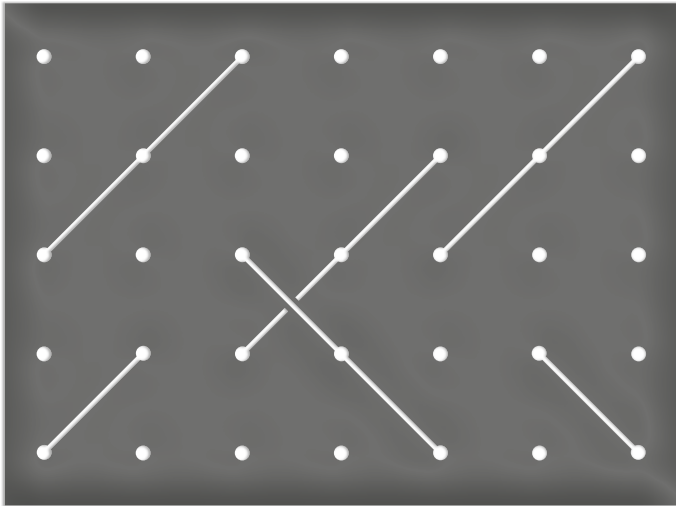

ART. SAR 01

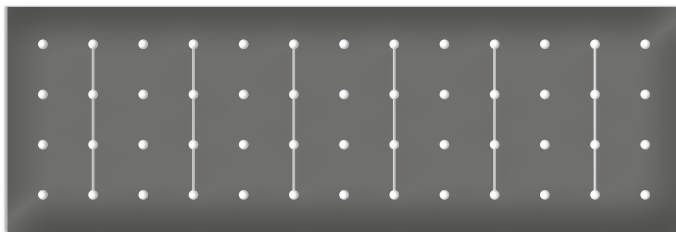

ART. SAR 06

LINEA SIDUS LINE



ART. SID 05

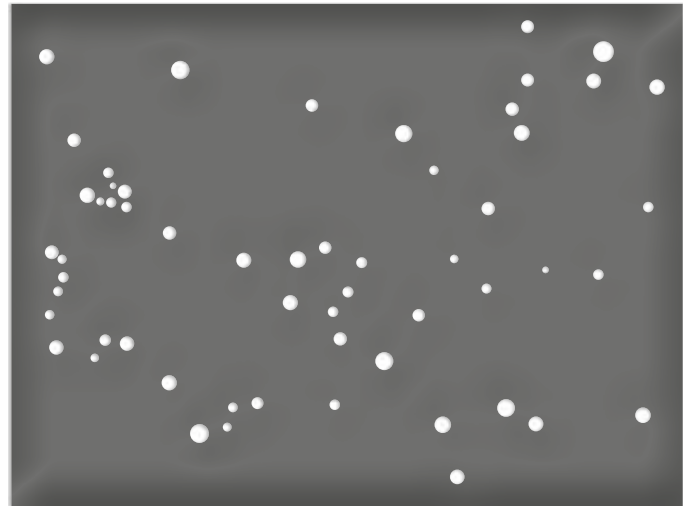

ART. SID 13



ART. SID 08

La fattibilità della realizzazione del decoro va verificata in base a dimensioni e spessori della lastra. / The feasibility of making certain decorations may depend on plate size and thickness.
 Tutte le parti di questo catalogo - foto comprese - sono di proprietà Euro-Fer. La riproduzione, anche parziale, è vietata in ogni forma e con ogni mezzo. / Every part of this catalogue - photos included - is Euro-Fer's property. All forms of copying are strictly prohibited.

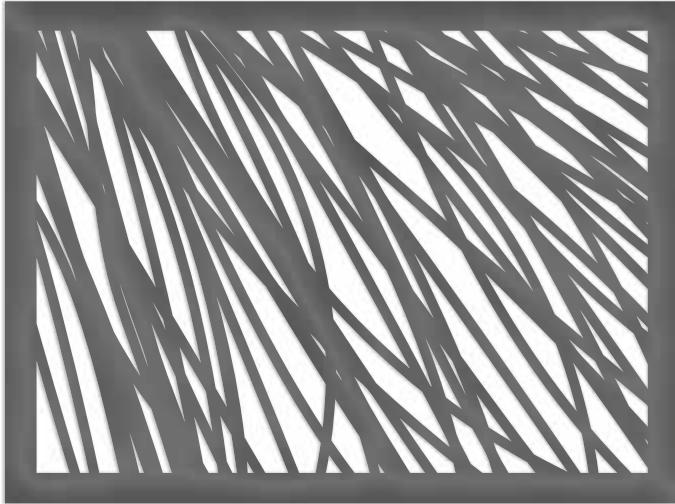

ART. RAM 01

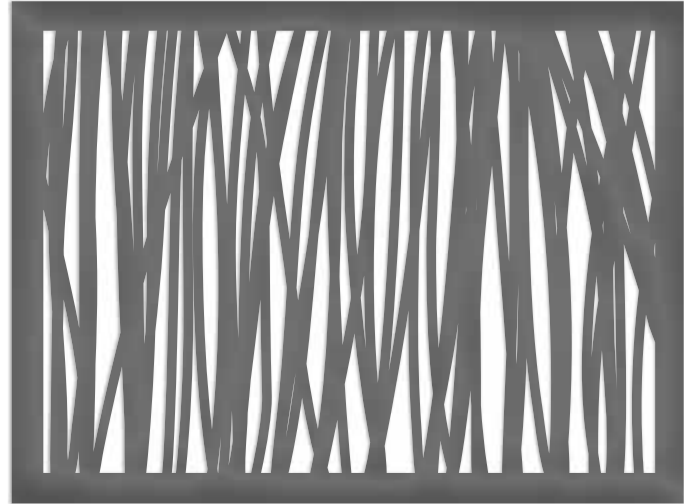

ART. RAM 02

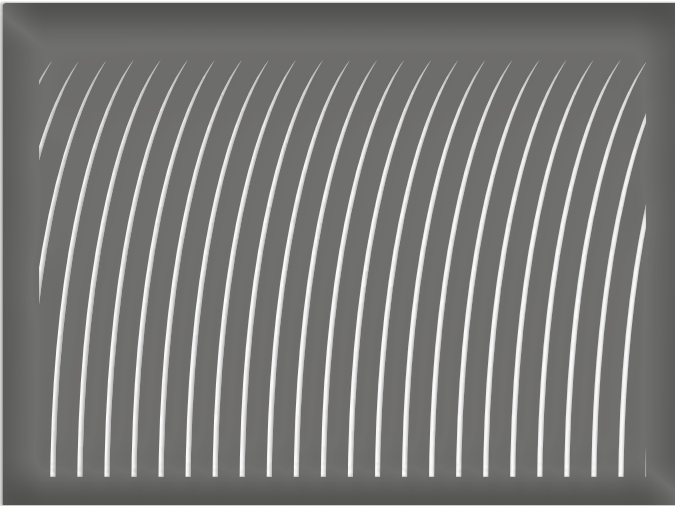

ART. RAM 03

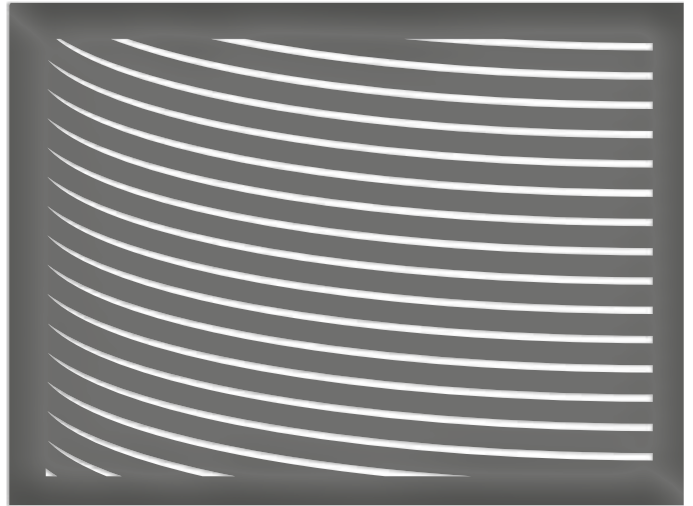

ART. RAM 04

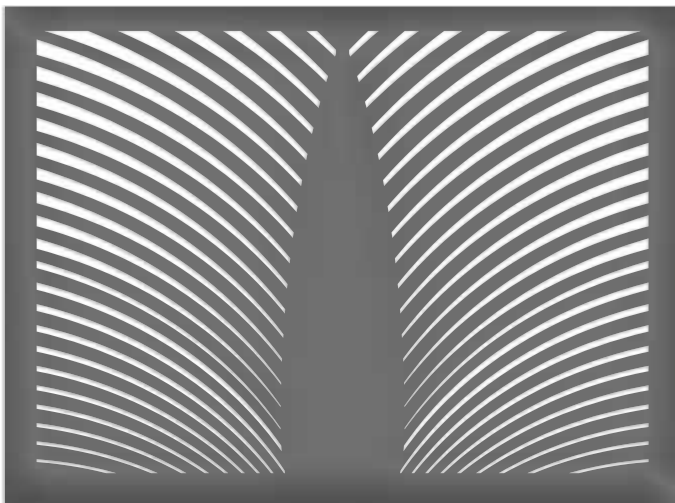

ART. RAM 05

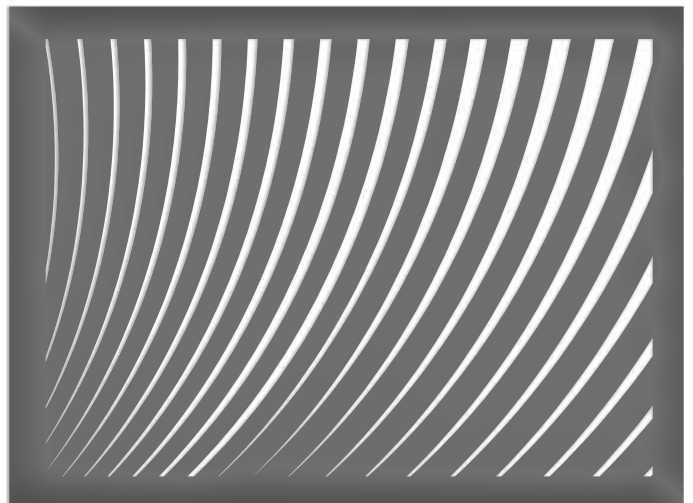

ART. RAM 06

La fattibilità della realizzazione del decoro va verificata in base a dimensioni e spessori della lastra. / The feasibility of making certain decorations may depend on plate size and thickness.

Tutte le parti di questo catalogo - foto comprese - sono di proprietà Euro-Fer. La riproduzione, anche parziale, è vietata in ogni forma e con ogni mezzo. / Every part of this catalogue - photos included - is Euro-Fer's property. All forms of copying are strictly prohibited.



La fattibilità della realizzazione del decoro va verificata in base a dimensioni e spessori della lastra. / The feasibility of making certain decorations may depend on plate size and thickness.
Tutte le parti di questo catalogo - foto comprese - sono di proprietà Euro-Fer. La riproduzione, anche parziale, è vietata in ogni forma e con ogni mezzo. / Every part of this catalogue - photos included - is Euro-Fer's property. All forms of copying are strictly prohibited.

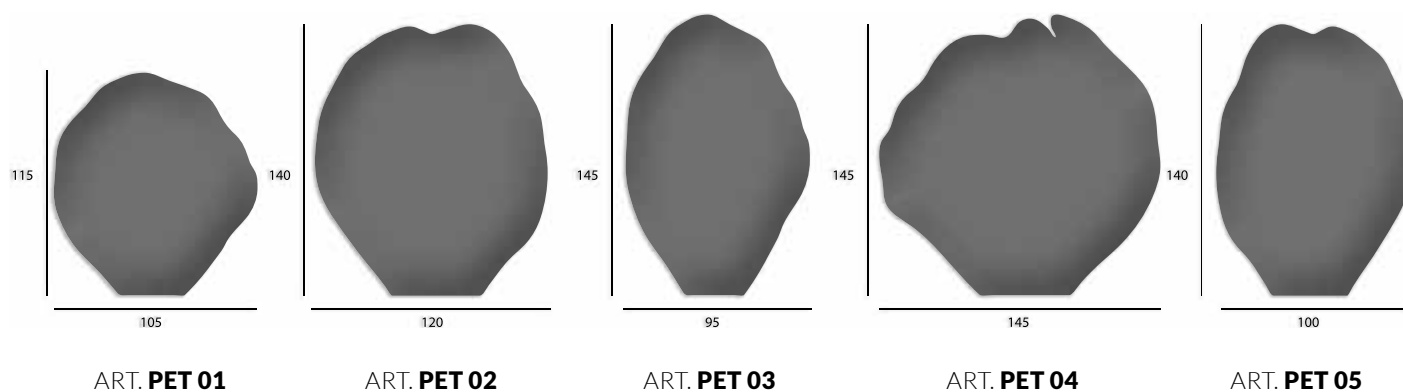

Petalis è un sistema modulare che può essere impiegato per dividere gli spazi, per creare zone indoor e outdoor, come parti di recinzioni, balaustrate. I petali si possono utilizzare sovrapposti, accostati o intervallati da altri elementi del catalogo Eurofer.

Petalis is a modular system that can be used to divide spaces, to create indoor and outdoor areas, such as parts of fences, balustrades. The petals can be used superimposed, juxtaposed or interspersed with other elements of the Eurofer catalog.



La fattibilità della realizzazione del decoro va verificata in base a dimensioni e spessori della lastra. / The feasibility of making certain decorations may depend on plate size and thickness.

Tutte le parti di questo catalogo - foto comprese - sono di proprietà Euro-Fer. La riproduzione, anche parziale, è vietata in ogni forma e con ogni mezzo. / Every part of this catalogue - photos included - is Euro-Fer's property. All forms of copying are strictly prohibited.





ART. PRO 01



ART. PRO 04

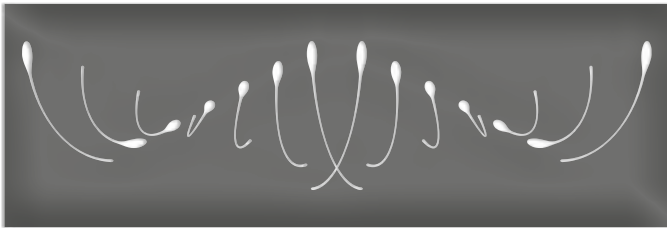

ART. PRO 02

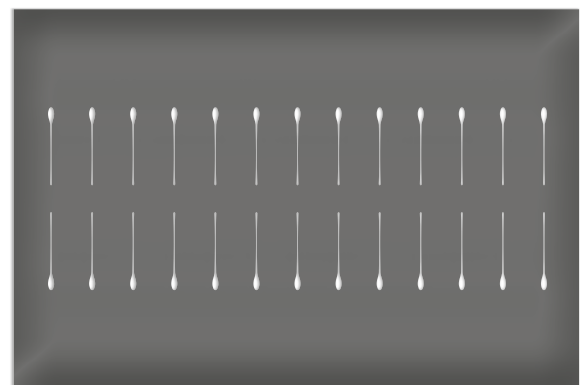

ART. PRO 05

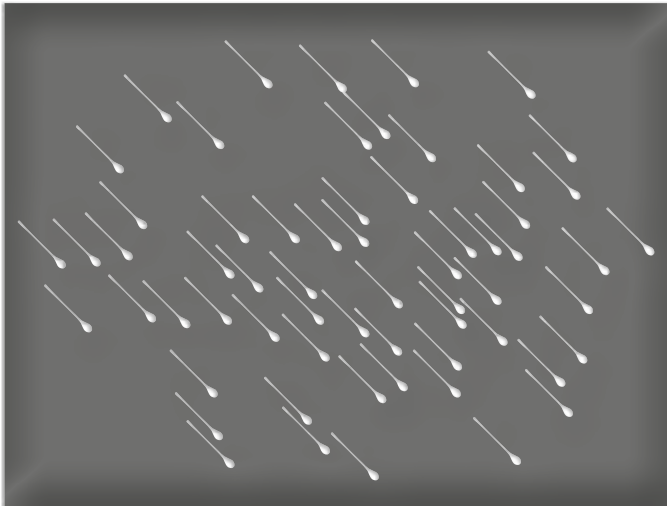

ART. PRO 03

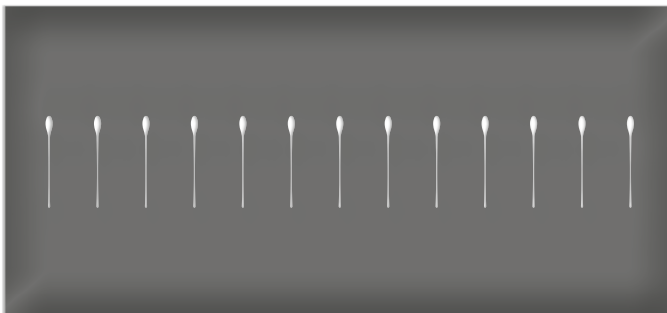

ART. PRO 06



La fattibilità della realizzazione del decoro va verificata in base a dimensioni e spessori della lastra. / The feasibility of making certain decorations may depend on plate size and thickness.

Tutte le parti di questo catalogo - foto comprese - sono di proprietà Euro-Fer. La riproduzione, anche parziale, è vietata in ogni forma e con ogni mezzo. / Every part of this catalogue - photos included - is Euro-Fer's property. All forms of copying are strictly prohibited.



ART. PRO 07

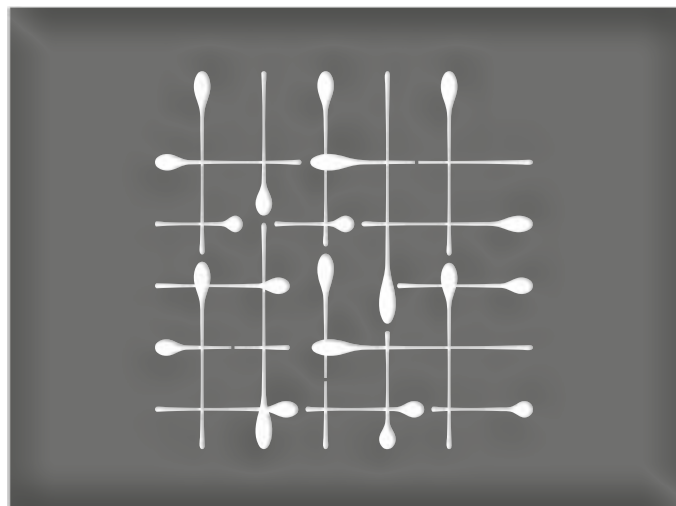

ART. PRO 11

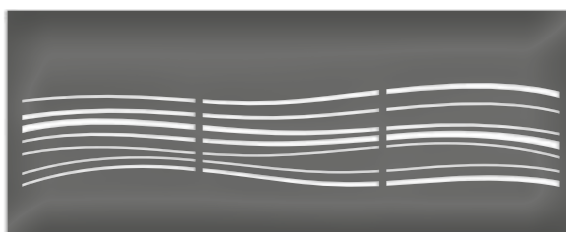

ART. PRO 08



ART. PRO 13



ART. PRO 10

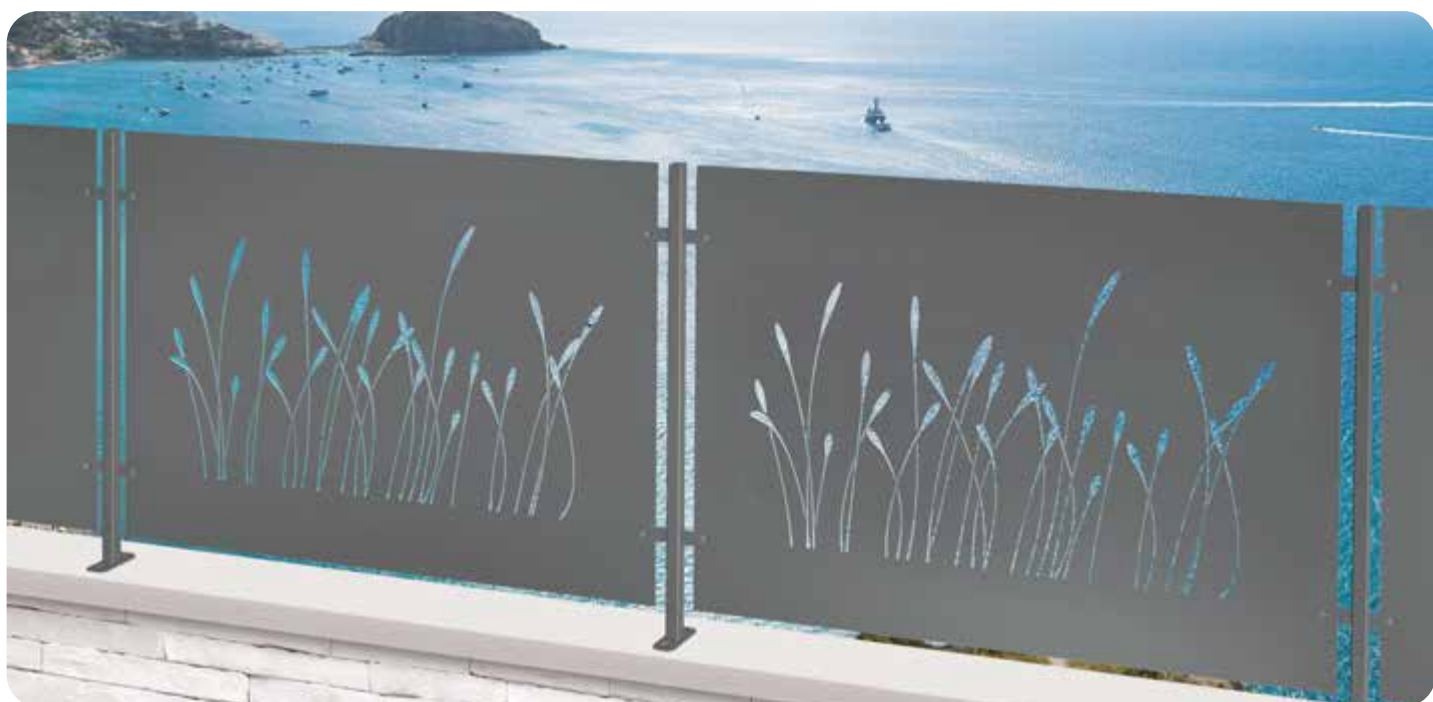

La fattibilità della realizzazione del decoro va verificata in base a dimensioni e spessori della lastra. / The feasibility of making certain decorations may depend on plate size and thickness.
 Tutte le parti di questo catalogo - foto comprese - sono di proprietà Euro-Fer. La riproduzione, anche parziale, è vietata in ogni forma e con ogni mezzo. / Every part of this catalogue - photos included - is Euro-Fer's property. All forms of copying are strictly prohibited.



ART. ROS 01



ART. ROS 02



ART. ROS 03



ART. ROS 04

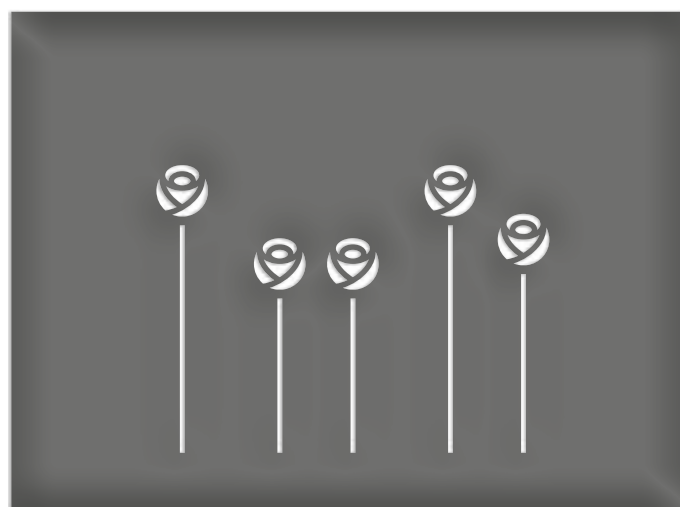

ART. ROS 05

La fattibilità della realizzazione del decoro va verificata in base a dimensioni e spessori della lastra. / The feasibility of making certain decorations may depend on plate size and thickness.

Tutte le parti di questo catalogo - foto comprese - sono di proprietà Euro-Fer. La riproduzione, anche parziale, è vietata in ogni forma e con ogni mezzo. / Every part of this catalogue - photos included - is Euro-Fer's property. All forms of copying are strictly prohibited.



ART. PHY 01



ART. PHY 02



ART. PHY 03



ART. PHY 04



La fattibilità della realizzazione del decoro va verificata in base a dimensioni e spessori della lastra. / The feasibility of making certain decorations may depend on plate size and thickness.

Tutte le parti di questo catalogo - foto comprese - sono di proprietà Euro-Fer. La riproduzione, anche parziale, è vietata in ogni forma e con ogni mezzo. / Every part of this catalogue - photos included - is Euro-Fer's property. All forms of copying are strictly prohibited.

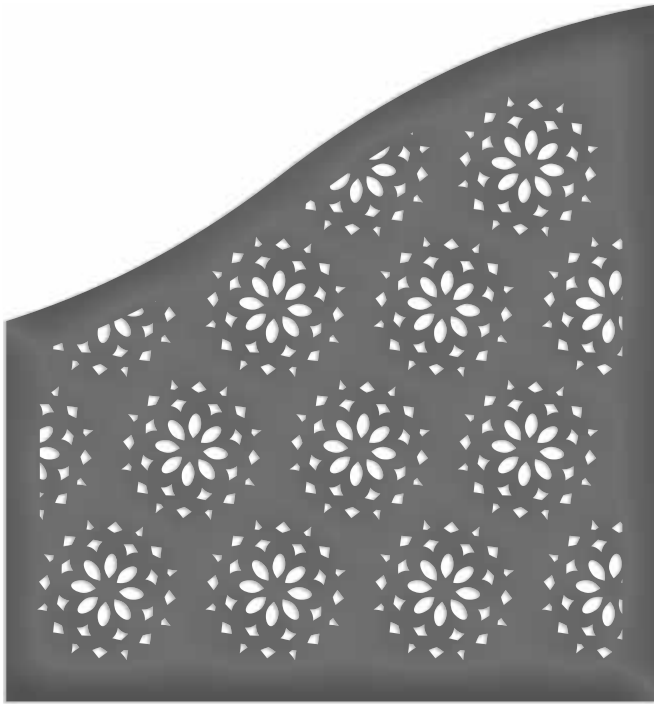
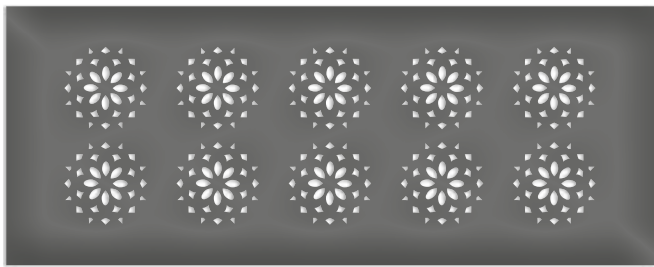
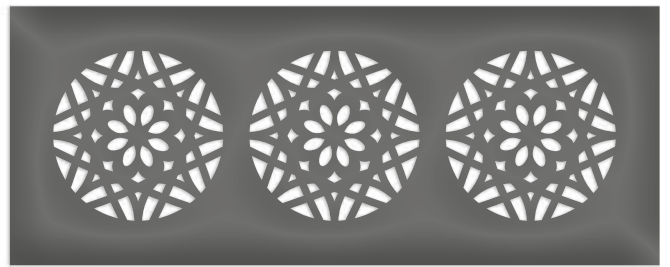
ART. **AST 01**ART. **AST 02**ART. **AST 05**ART. **AST 06**

La fattibilità della realizzazione del decoro va verificata in base a dimensioni e spessori della lastra. / The feasibility of making certain decorations may depend on plate size and thickness.

Tutte le parti di questo catalogo - foto comprese - sono di proprietà Euro-Fer. La riproduzione, anche parziale, è vietata in ogni forma e con ogni mezzo. / Every part of this catalogue - photos included - is Euro-Fer's property. All forms of copying are strictly prohibited.

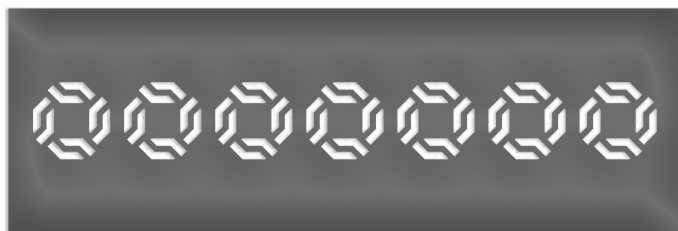

ART. OTT 02

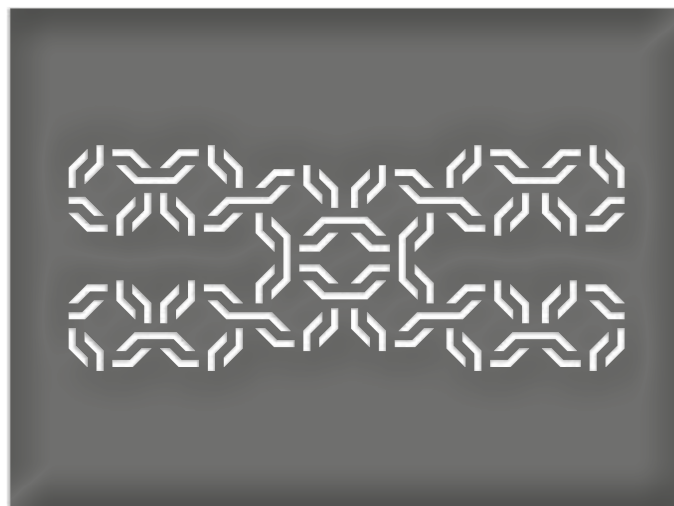

ART. OTT 03



ART. OTT 04



ART. OTT 07

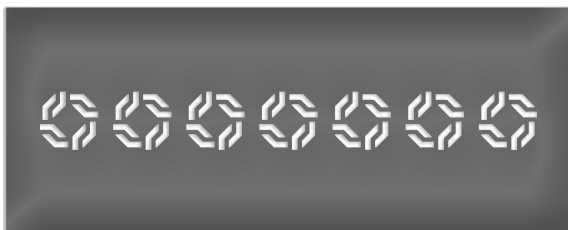

ART. OTT 08

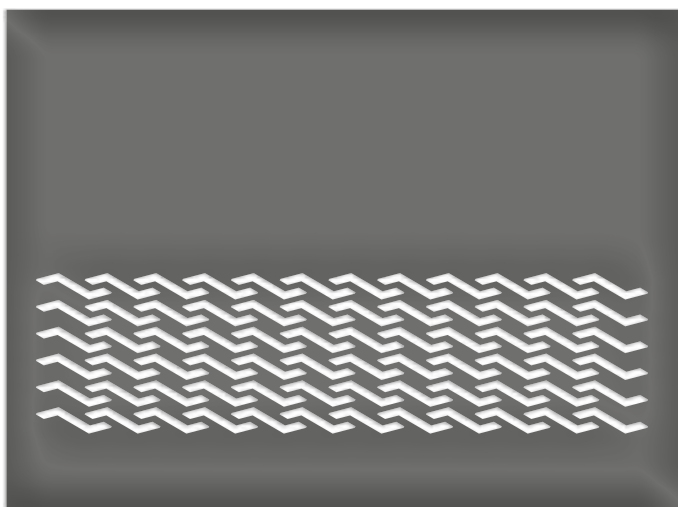

ART. OTT 11

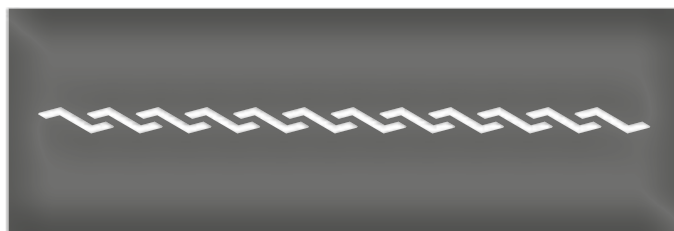

ART. OTT 12

La fattibilità della realizzazione del decoro va verificata in base a dimensioni e spessori della lastra. / The feasibility of making certain decorations may depend on plate size and thickness.

Tutte le parti di questo catalogo - foto comprese - sono di proprietà Euro-Fer. La riproduzione, anche parziale, è vietata in ogni forma e con ogni mezzo. / Every part of this catalogue - photos included - is Euro-Fer's property. All forms of copying are strictly prohibited.

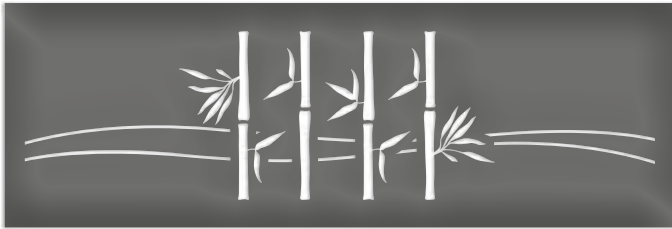
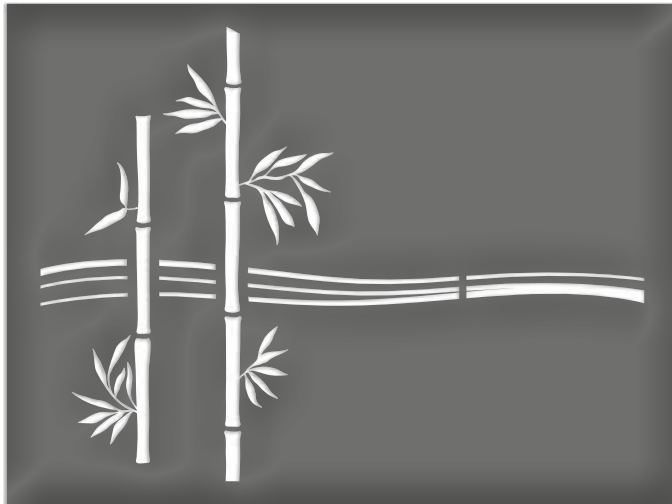
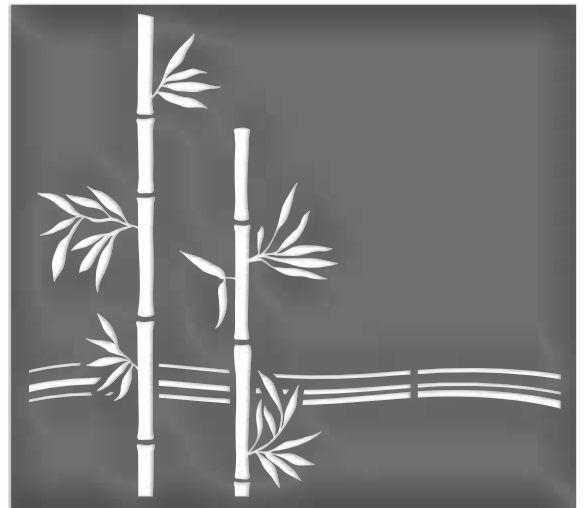
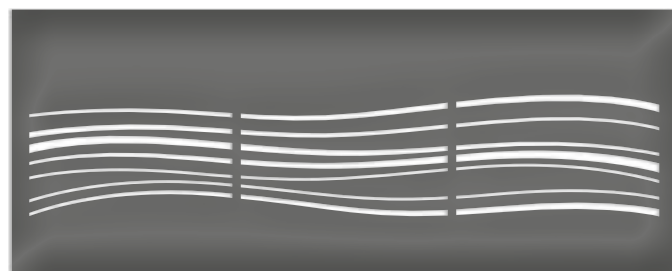
ART. **CAN 01**ART. **CAN 04**ART. **CAN 02**ART. **CAN 05**ART. **CAN 03**ART. **CAN 07**ART. **CAN 08**

La fattibilità della realizzazione del decoro va verificata in base a dimensioni e spessori della lastra. / The feasibility of making certain decorations may depend on plate size and thickness.

Tutte le parti di questo catalogo - foto comprese - sono di proprietà Euro-Fer. La riproduzione, anche parziale, è vietata in ogni forma e con ogni mezzo. / Every part of this catalogue - photos included - is Euro-Fer's property. All forms of copying are strictly prohibited.



ART. CAN 09

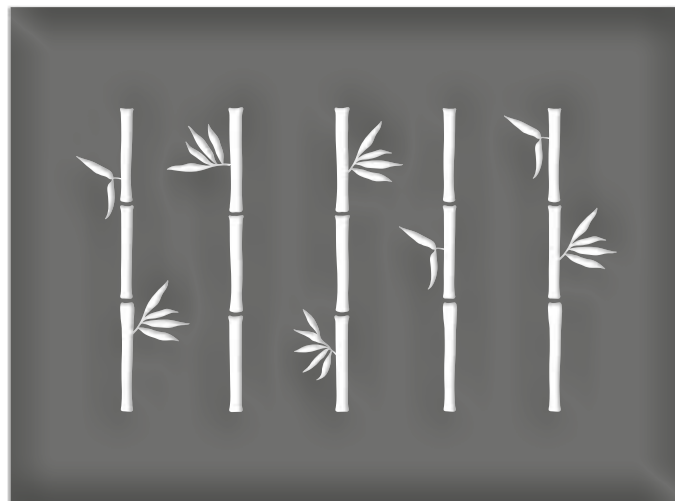

ART. CAN 11

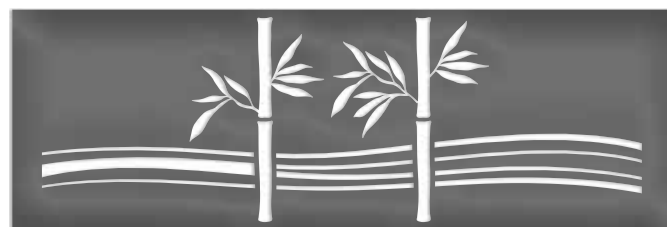

ART. CAN 12



La fattibilità della realizzazione del decoro va verificata in base a dimensioni e spessori della lastra. / The feasibility of making certain decorations may depend on plate size and thickness.
 Tutte le parti di questo catalogo - foto comprese - sono di proprietà Euro-Fer. La riproduzione, anche parziale, è vietata in ogni forma e con ogni mezzo. / Every part of this catalogue - photos included - is Euro-Fer's property. All forms of copying are strictly prohibited.

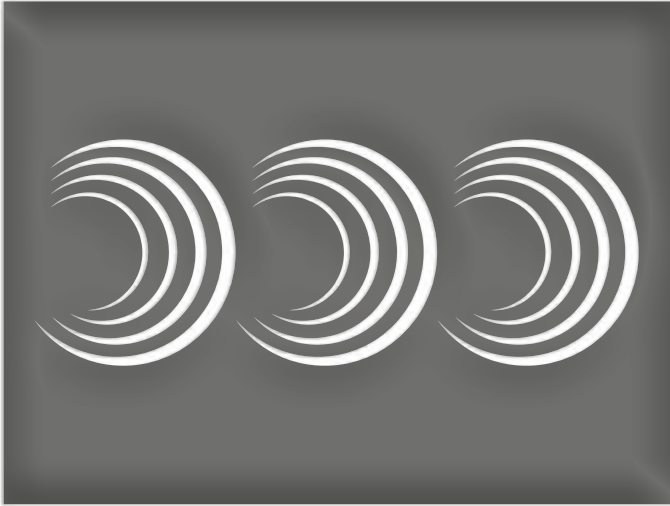

ART. SEC 01

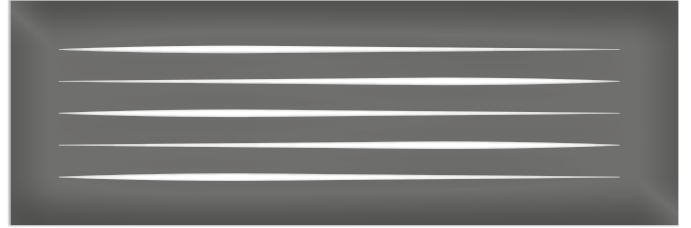

ART. SEC 02

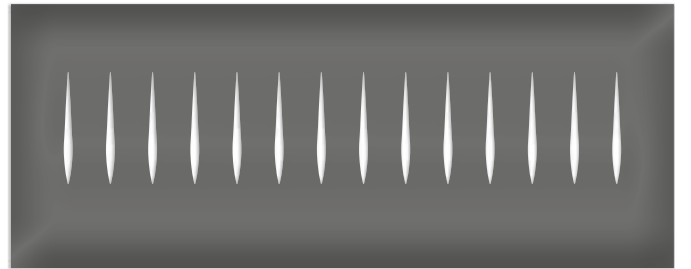

ART. SEC 08

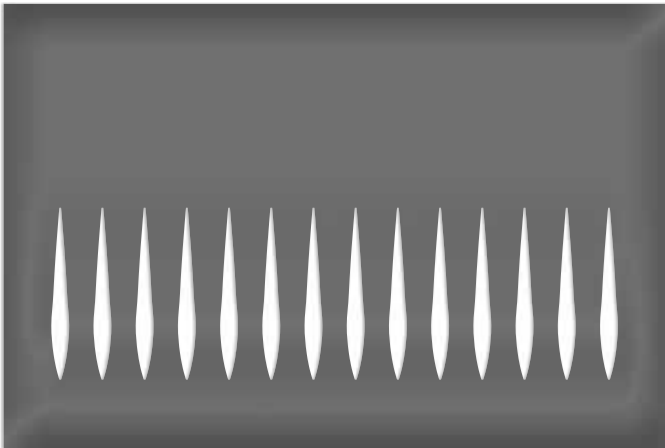

ART. SEC 05



ART. SEC 12

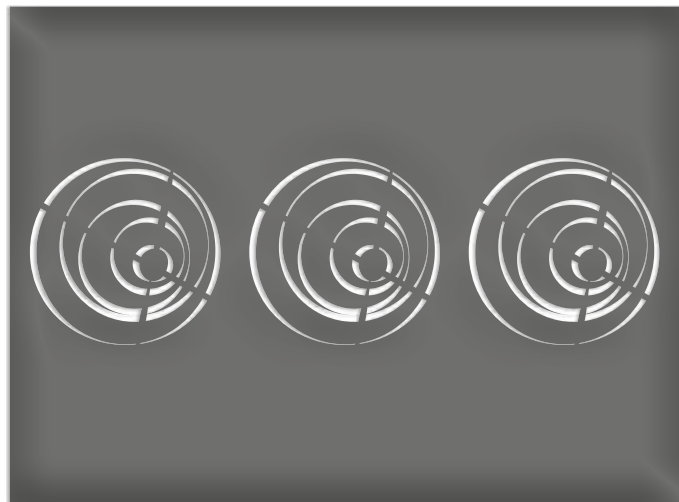

ART. SEC 11

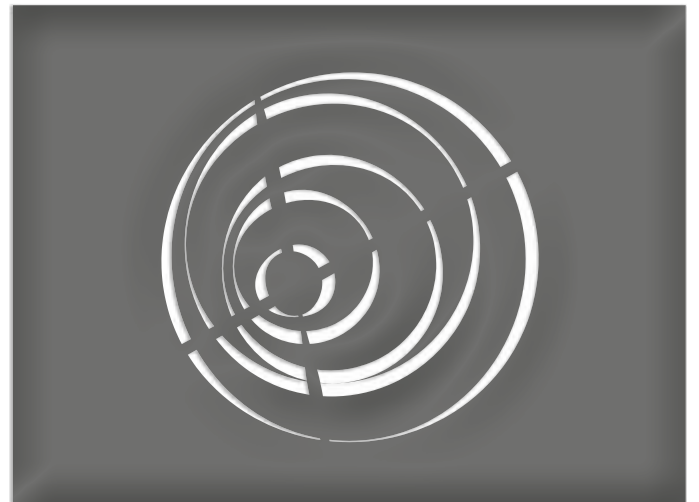

ART. SEC 13

La fattibilità della realizzazione del decoro va verificata in base a dimensioni e spessori della lastra. / The feasibility of making certain decorations may depend on plate size and thickness.

Tutte le parti di questo catalogo - foto comprese - sono di proprietà Euro-Fer. La riproduzione, anche parziale, è vietata in ogni forma e con ogni mezzo. / Every part of this catalogue - photos included - is Euro-Fer's property. All forms of copying are strictly prohibited.



ART. SOL 01

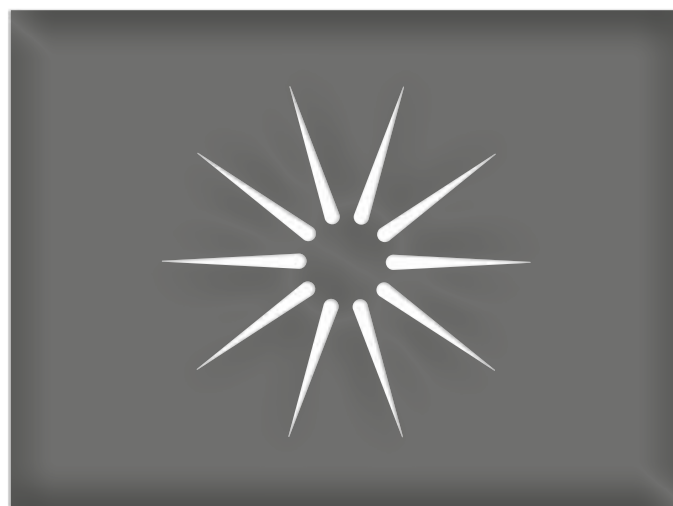

ART. SOL 02



ART. SOL 03



ART. SOL 04

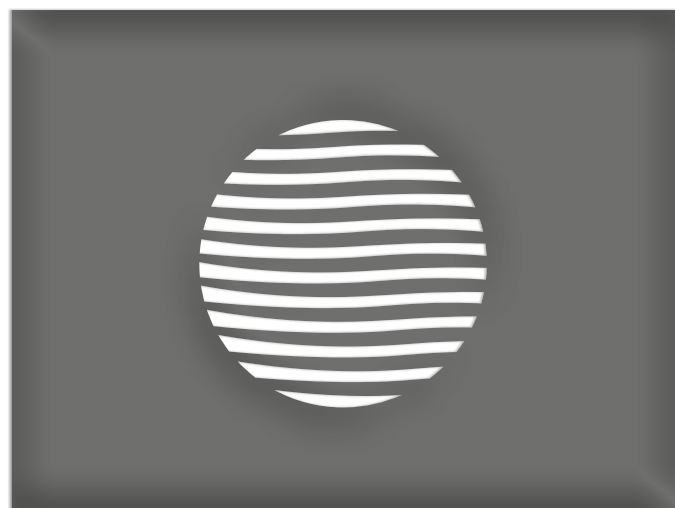

ART. SOL 05



ART. SOL 06

La fattibilità della realizzazione del decoro va verificata in base a dimensioni e spessori della lastra. / The feasibility of making certain decorations may depend on plate size and thickness.

Tutte le parti di questo catalogo - foto comprese - sono di proprietà Euro-Fer. La riproduzione, anche parziale, è vietata in ogni forma e con ogni mezzo. / Every part of this catalogue - photos included - is Euro-Fer's property. All forms of copying are strictly prohibited.

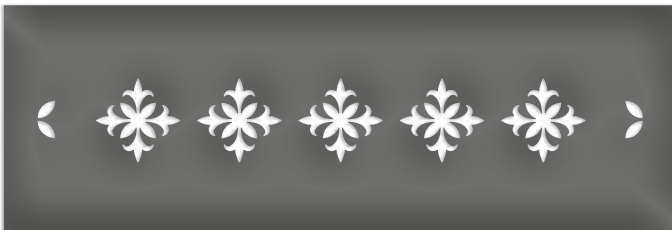
ART. **ACA 01**ART. **ACA 02**ART. **ACA 03**ART. **ACA 04**

La fattibilità della realizzazione del decoro va verificata in base a dimensioni e spessori della lastra. / The feasibility of making certain decorations may depend on plate size and thickness.

Tutte le parti di questo catalogo - foto comprese - sono di proprietà Euro-Fer. La riproduzione, anche parziale, è vietata in ogni forma e con ogni mezzo. / Every part of this catalogue - photos included - is Euro-Fer's property. All forms of copying are strictly prohibited.

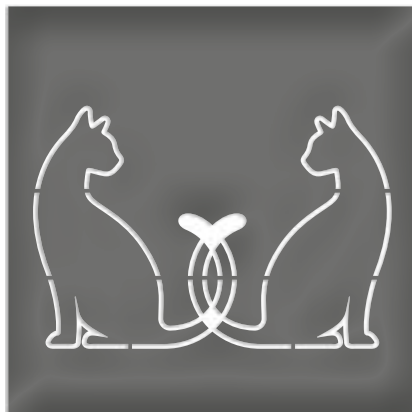

ART. CAT 01



ART. MIS 01



ART. MIS 02



ART. MIS 03

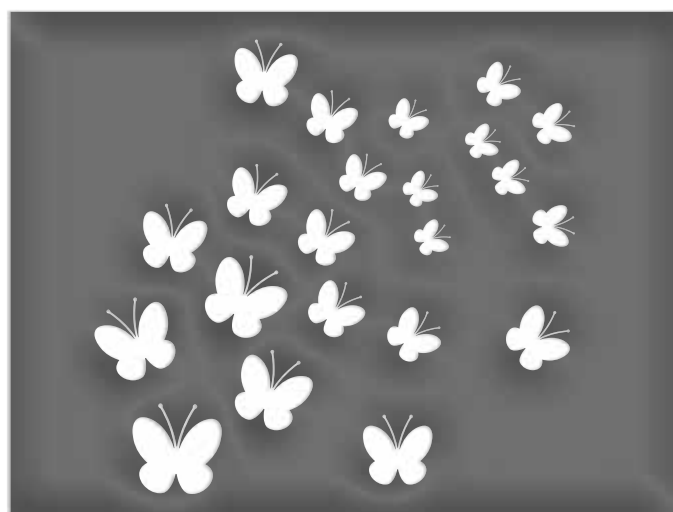

ART. MIS 05



ART. MIS 04

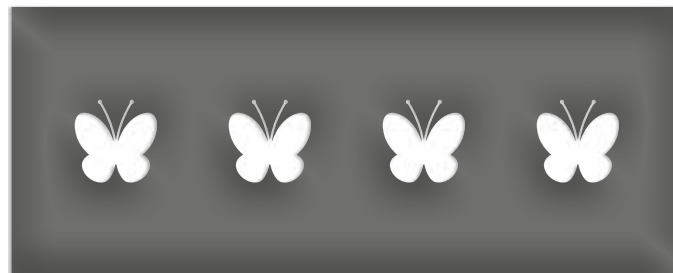

ART. MIS 06



ART. MIS 07

La fattibilità della realizzazione del decoro va verificata in base a dimensioni e spessori della lastra. / The feasibility of making certain decorations may depend on plate size and thickness.

Tutte le parti di questo catalogo - foto comprese - sono di proprietà Euro-Fer. La riproduzione, anche parziale, è vietata in ogni forma e con ogni mezzo. / Every part of this catalogue - photos included - is Euro-Fer's property. All forms of copying are strictly prohibited.

SPESSORE / THICKNESS mm 6 - 8

- 15 -



410x330 mm

LR001.60/10.FE
LR001.80/10.FE

- 12,5 -



410x330 mm

LR004.60/10.FE
LR004.80/10.FE

- 12,5 -



410x330 mm

LR005.60/10.FE
LR005.80/10.FE

- 12,5 -



410x330 mm

LR006.60/10.FE
LR006.80/10.FE

- 15 -



430x350 mm

LR007.60/10.FE
LR007.80/10.FE

- 15 -



430x350 mm

LR008.60/10.FE
LR008.80/10.FE

- 15 -



430x350 mm

LR009.60/10.FE
LR009.80/10.FE

- 15 -



430x350 mm

LR010.60/10.FE
LR010.80/10.FE

- 15 -



430x350 mm

LR011.60/10.FE
LR011.80/10.FE

- 15 -



430x350 mm

LR0110.60/10.FE
LR0110.80/10.FE

- 15 -



430x350 mm

LR0111.60/10.FE
LR0111.80/10.FE

La fattibilità della realizzazione del decoro va verificata in base a dimensioni e spessori della lastra. / The feasibility of making certain decorations may depend on plate size and thickness.

Tutte le parti di questo catalogo - foto comprese - sono di proprietà Euro-Fer. La riproduzione, anche parziale, è vietata in ogni forma e con ogni mezzo. / Every part of this catalogue - photos included - is Euro-Fer's property. All forms of copying are strictly prohibited.

- 12,5 -



290x160 mm

LR012.60/10.FE
LR012.80/10.FE

- 12,5 -



290x160 mm

LR013.60/10.FE
LR013.80/10.FE

- 12,5 -



290x160 mm

LR014.60/10.FE
LR014.80/10.FE

- 15 -



290x160 mm

LR015.60/10.FE
LR015.80/10.FE

- 15 -



290x160 mm

LR016.60/10.FE
LR016.80/10.FE



La fattibilità della realizzazione del decoro va verificata in base a dimensioni e spessori della lastra. / The feasibility of making certain decorations may depend on plate size and thickness.

Tutte le parti di questo catalogo - foto comprese - sono di proprietà Euro-Fer. La riproduzione, anche parziale, è vietata in ogni forma e con ogni mezzo. / Every part of this catalogue - photos included - is Euro-Fer's property. All forms of copying are strictly prohibited.

- 12,5 -



430x150 mm

LR023.60/10.FE
LR023.80/10.FE

- 12,5 -



430x150 mm

LR024.60/10.FE
LR024.80/10.FE

- 15 -



430x150 mm

LR026.60/10.FE
LR026.80/10.FE

- 15 -



430x150 mm

LR027.60/10.FE
LR027.80/10.FE

- 15 -



430x150 mm

LR028.60/10.FE
LR028.80/10.FE

- 15 -



430x150 mm

LR029.60/10.FE
LR029.80/10.FE

- 15 -



376x160 mm

LR030.60/10.FE
LR030.80/10.FE

- 15 -



288x160 mm

LR031.60/10.FE
LR031.80/10.FE

- 15 -



435x160 mm

LR032.60/10.FE
LR032.80/10.FE

- 15 -



435x160 mm

LR033.60/10.FE
LR033.80/10.FE

TERMINALI ferro grezzo / POST TOPS raw iron

SPESSORE / THICKNESS mm 6 - 8

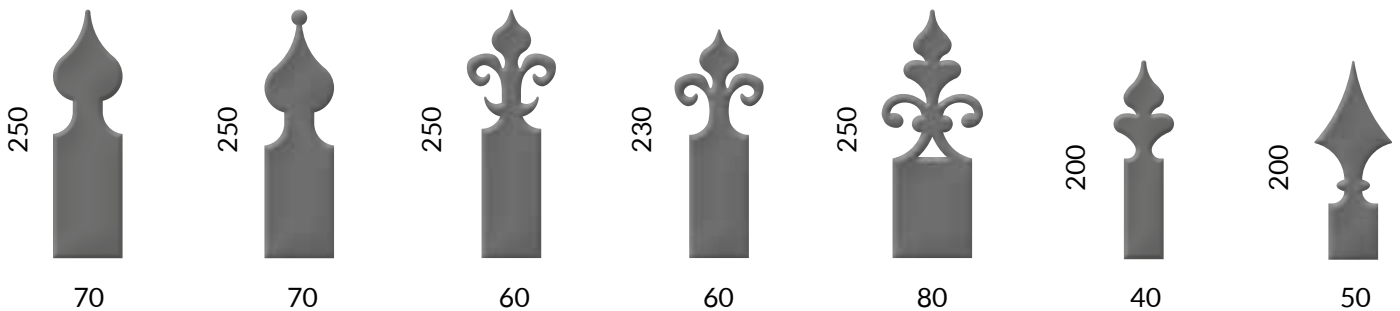
LT001.60/10.FE
LT001.80/10.FELT002.60/10.FE
LT002.80/10.FELT003.60/10.FE
LT003.80/10.FELT004.60/10.FE
LT004.80/10.FELT005.60/10.FE
LT005.80/10.FELT006.60/10.FE
LT006.80/10.FELT007.60/10.FE
LT007.80/10.FE

La fattibilità della realizzazione del decoro va verificata in base a dimensioni e spessori della lastra. / The feasibility of making certain decorations may depend on plate size and thickness.

Tutte le parti di questo catalogo - foto comprese - sono di proprietà Euro-Fer. La riproduzione, anche parziale, è vietata in ogni forma e con ogni mezzo. / Every part of this catalogue - photos included - is Euro-Fer's property. All forms of copying are strictly prohibited.

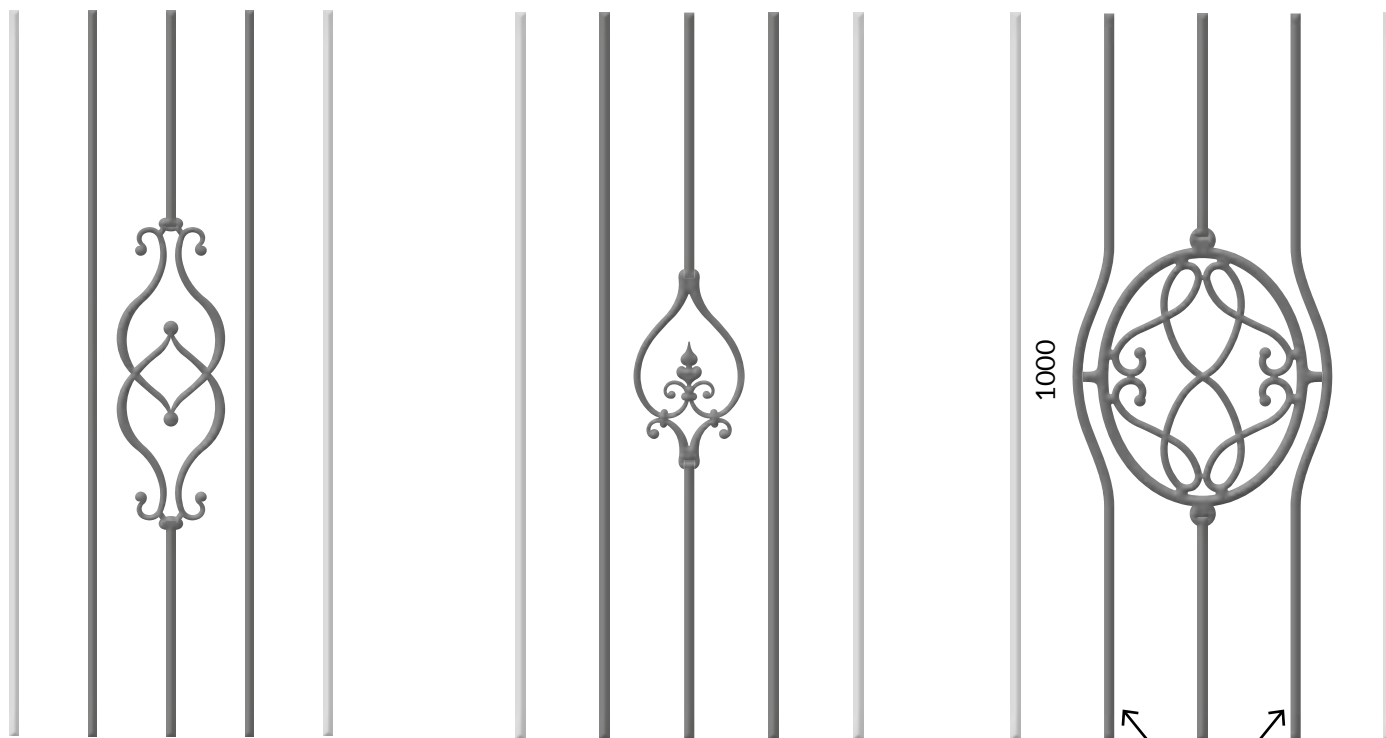

LQ12.SAG.H1000

LQ14.SAG.H1000



La fattibilità della realizzazione del decoro va verificata in base a dimensioni e spessori della lastra. / The feasibility of making certain decorations may depend on plate size and thickness.

Tutte le parti di questo catalogo - foto comprese - sono di proprietà Euro-Fer. La riproduzione, anche parziale, è vietata in ogni forma e con ogni mezzo. / Every part of this catalogue - photos included - is Euro-Fer's property. All forms of copying are strictly prohibited.

Richiedere scheda informativa all'ufficio tecnico.
Please contact the technical office for more information.



NEW



98

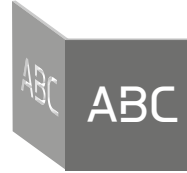

PIASTRE PER PIANTONI ferro grezzo / BASE PLATES raw iron

SPESSORE / THICKNESS mm 4 - 6

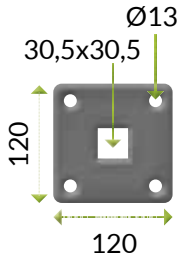

LP001.40/10.FE
LP001.60/10.FE

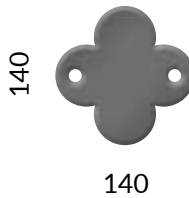

LP002.40/10.FE
LP002.60/10.FE

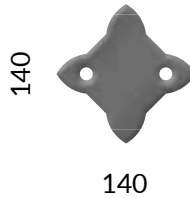

LP003.40/10.FE
LP003.60/10.FE



LP004.40/10.FE
LP004.60/10.FE

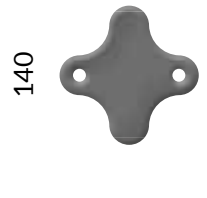

LP005.40/10.FE
LP005.60/10.FE

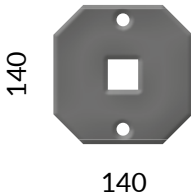

LP006.40/10.FE
LP006.60/10.FE

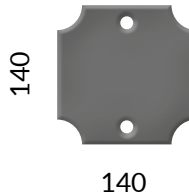

LP007.40/10.FE
LP007.60/10.FE

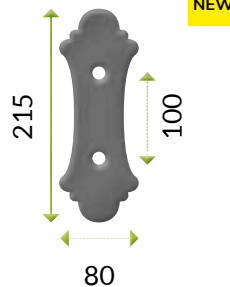

LP008.40/10.FE
LP008.60/10.FE

NEW



STAFFE DI FISSAGGIO ferro grezzo / LUGS & FIXINGS raw iron

SPESSORE / THICKNESS mm 4 - 6



LS001.40/10.FE
LS001.60/10.FE

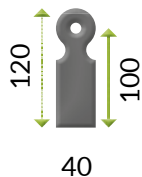

LS002.40/10.FE
LS002.60/10.FE

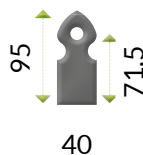

LS003.40/10.FE
LS003.60/10.FE



LS004.40/10.FE
LS004.60/10.FE



LS005.40/10.FE
LS005.60/10.FE

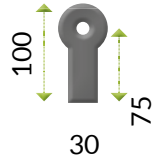

LS006.40/10.FE
LS006.60/10.FE

La fattibilità della realizzazione del decoro va verificata in base a dimensioni e spessori della lastra. / The feasibility of making certain decorations may depend on plate size and thickness.

Tutte le parti di questo catalogo - foto comprese - sono di proprietà Euro-Fer. La riproduzione, anche parziale, è vietata in ogni forma e con ogni mezzo. / Every part of this catalogue - photos included - is Euro-Fer's property. All forms of copying are strictly prohibited.

SPESSORE / THICKNESS mm 4 - 6



1000x120 mm
 LG001.40/10.FE
 LG001.60/10.FE



1000x100 mm
 LG005.40/10.FE
 LG005.60/10.FE



1200x120 mm
 LG008.40/10.FE
 LG008.60/10.FE

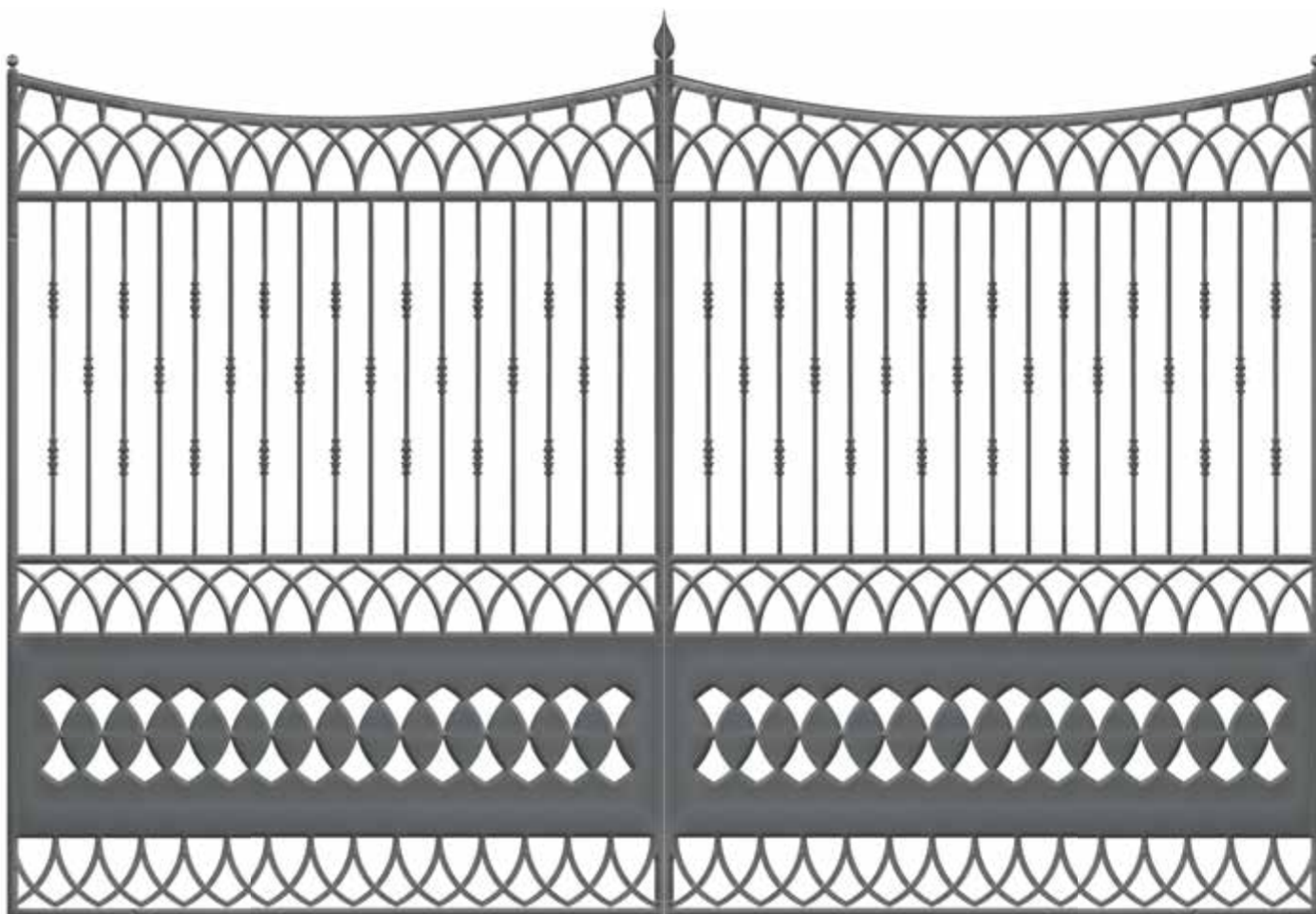

esempio / example



1200x120 mm
 LG009.40/10.FE
 LG009.60/10.FE



1200x100 mm
 LG014.40/10.FE
 LG014.60/10.FE

La fattibilità della realizzazione del decoro va verificata in base a dimensioni e spessori della lastra. / The feasibility of making certain decorations may depend on plate size and thickness.
 Tutte le parti di questo catalogo - foto comprese - sono di proprietà Euro-Fer. La riproduzione, anche parziale, è vietata in ogni forma e con ogni mezzo. / Every part of this catalogue - photos included - is Euro-Fer's property. All forms of copying are strictly prohibited.

SPESSORE / THICKNESS mm 4 - 6

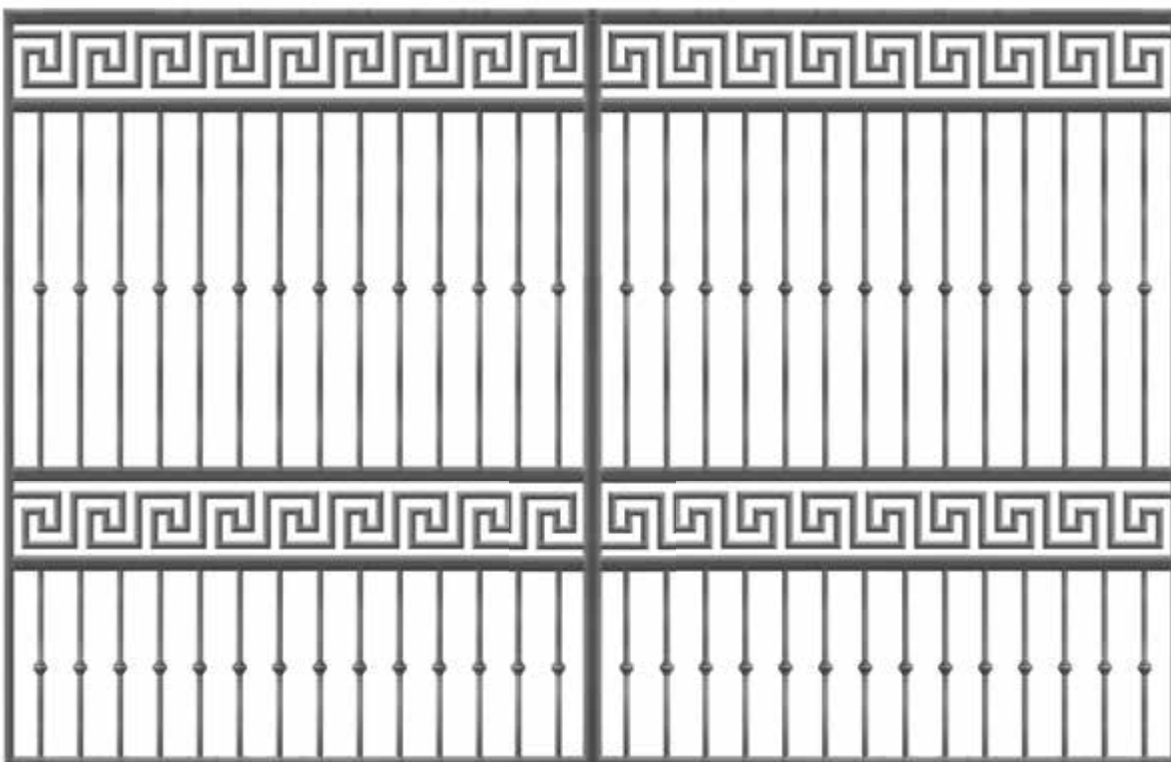

esempio / example

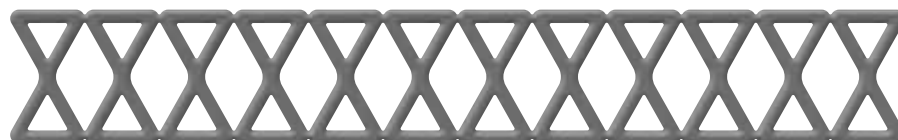
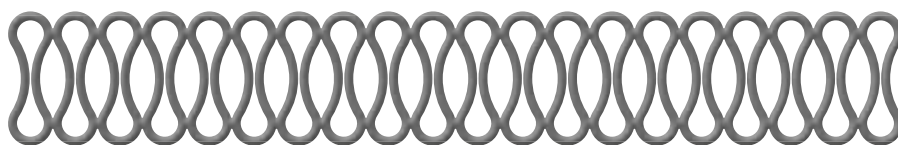
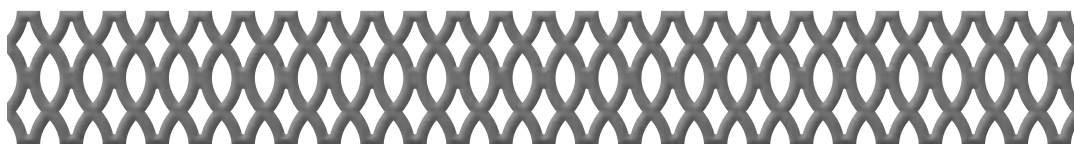

La fattibilità della realizzazione del decoro va verificata in base a dimensioni e spessori della lastra. / The feasibility of making certain decorations may depend on plate size and thickness.

Tutte le parti di questo catalogo - foto comprese - sono di proprietà Euro-Fer. La riproduzione, anche parziale, è vietata in ogni forma e con ogni mezzo. / Every part of this catalogue - photos included - is Euro-Fer's property. All forms of copying are strictly prohibited.

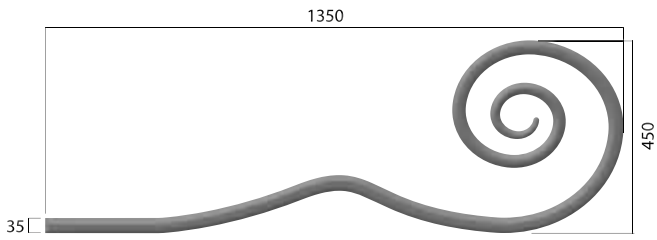

Vendute in coppia
Sold in pairs 2 p.

LC001.40/10.FE
LC001.60/10.FE

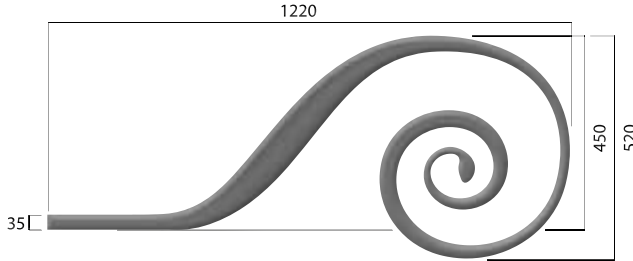

Vendute in coppia
Sold in pairs 2 p.

LC002.40/10.FE
LC002.60/10.FE

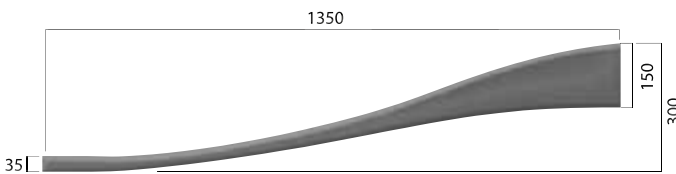

Vendute in coppia
Sold in pairs 2 p.

LC003.40/10.FE
LC003.60/10.FE



Vendute in coppia
Sold in pairs 2 p.

LC004.40/10.FE
LC004.60/10.FE

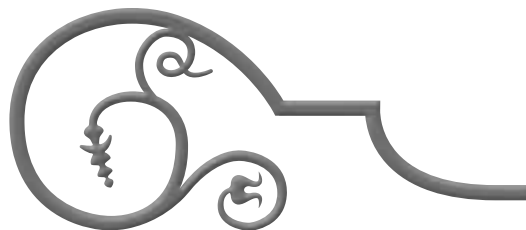
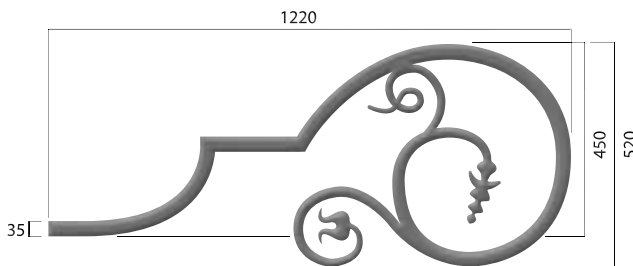

Vendute in coppia
Sold in pairs 2 p.

LC005.40/10.FE
LC005.60/10.FE



Vendute singolarmente
Sold individually 1 p.
LC006.40/10.FE
LC006.60/10.FE

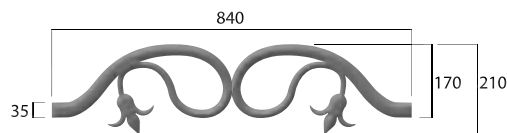

Vendute singolarmente
Sold individually 1 p.

LC007.40/10.FE
LC007.60/10.FE

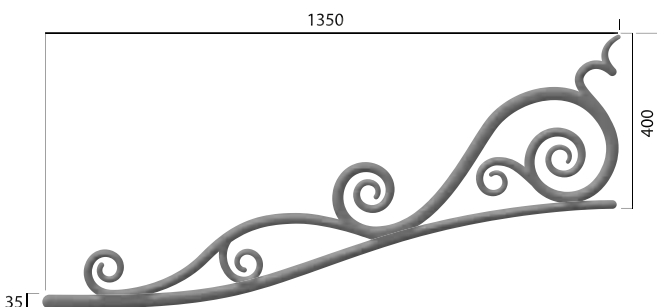

Vendute in coppia
Sold in pairs 2 p.

LC008.40/10.FE
LC008.60/10.FE

La fattibilità della realizzazione del decoro va verificata in base a dimensioni e spessori della lastra. / The feasibility of making certain decorations may depend on plate size and thickness.

Tutte le parti di questo catalogo - foto comprese - sono di proprietà Euro-Fer. La riproduzione, anche parziale, è vietata in ogni forma e con ogni mezzo. / Every part of this catalogue - photos included - is Euro-Fer's property. All forms of copying are strictly prohibited.

Le linee Eurofer / Eurofer lines



FERRO BATTUTO / WROUGHT IRON



ACCIAIO INOX / STAINLESS STEEL



LASERFER



RECINZIONI / MODULAR FENCES



CANCELLI / GATES



GRADIUS ALUMINIUM

PALIXON



BAND|BOO®



ROSE COLLECTION CRYSTALS FROM SWAROVSKI®





Tutte le parti di questo catalogo -foto, disegni, testi e grafica- sono di proprietà Euro-Fer®. La loro riproduzione, pubblicazione, trasmissione, duplicazione e comunicazione anche solo parziale sono vietate in ogni forma e con ogni mezzo salvo espressa autorizzazione di Euro-Fer® spa.

Dati, foto e caratteristiche tecniche non sono impegnativi. Euro-Fer® si riserva il diritto di apportare modifiche che riterrà opportune per migliorare i suoi prodotti.

Euro-Fer® è un marchio registrato. Tutti i diritti riservati.

All the parts of this catalogue -photos, drawings, designs and texts- are Euro-Fer® spa property. Their partial or total publication, transmission, copy, communication or other duplication are forbidden without special consent by Euro-Fer®spa.

Data, photos and technical characteristics are not binding. Euro-Fer® reserves the right to change the content of this catalogue without notice.

Euro-Fer® is a registered trademark. All rights reserved.



Euro-Fer è un'azienda amica dell'ambiente e alimenta gran parte del ciclo produttivo con energia solare.

Euro-Fer is an environmentally-friendly company that uses solar energy in most of its production cycle.

EUROFER®

LAVORAZIONE DEL FERRO BATTUTO & ACCIAIO INOX
WROUGHT IRON & STAINLESS STEEL WORKING

EURO-FER S.p.A.

Viale dell'Industria, 16/18
Castelgomberto (Vicenza) Italy

tel +39 0445 440033

fax +39 0445 440351

e-mail eurofer@eurofer.com

 EuroFer S.P.A.

 euroferspa

 Euro-Fer
Euro-Fer Rose

www.eurofer.com



www.rosecollection.it



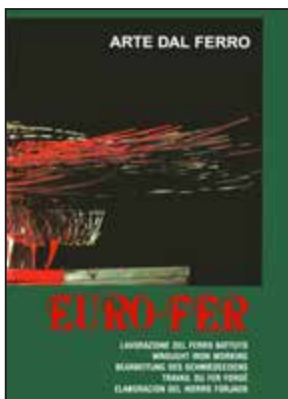

Art. 1000
Arte dal ferro / Art of wrought iron
 1300 articoli / articles
 2700 variazioni di sezioni e di altezze /
different sections and heights
 50 disegni di composizioni dimostrative
 / design of possible creations

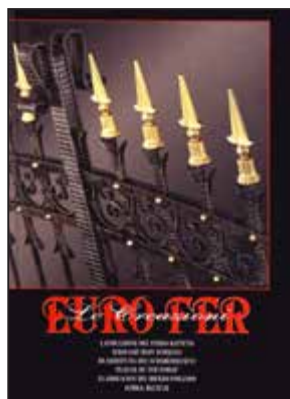

Art. 2000
Le creazioni Euro-Fer
Euro-Fer creations
 circa 1000 articoli / articles
 2400 variazioni di sezioni e di altezze
 / *different sections and heights*
 oltre 100 foto di realizzazioni / more
 than 100 foto of creations

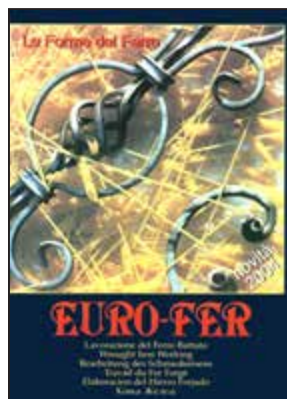

Art. 4000
Le forme del ferro
The shapes of iron



Art. 4100
Tra ferro e fuoco
Between iron and fire

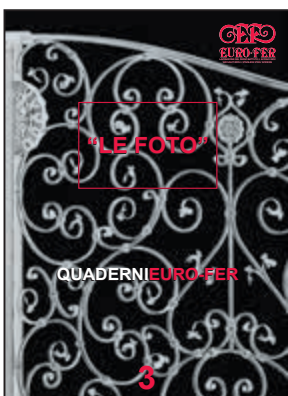

Art. 5002
Le foto

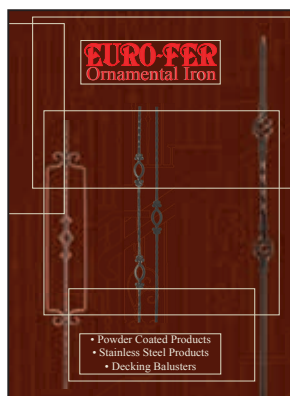

Art. 10000
Powder coated products



Art. 00EZ
EZ Inox
 EZ-inox: l'inox facile
 Ez-inox: easy inox



Art. 9000
Cancelli Linear e Gradius
 Moduli zincati pronti per
 l'installazione / Galvanized modules
 ready to use

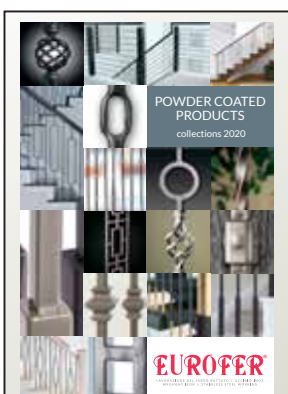

Art. 12000
Powder Coated Products



Art. 11000
Rose Collection
 Collezione Rose realizzata in ferro
 battuto o in acciaio inox con inserti di
 cristallo, utilizzo per interni.
*Indoor collection Rose, an innovative
 combination between ornamental
 wrought iron, or stainless steel
 products, made with crystal inserts.*

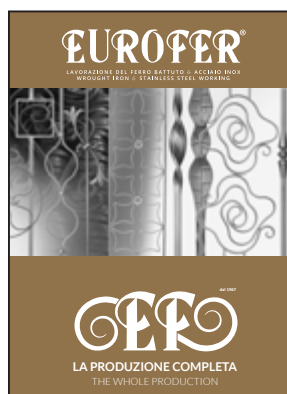

Art. 7003
La produzione completa
The whole production

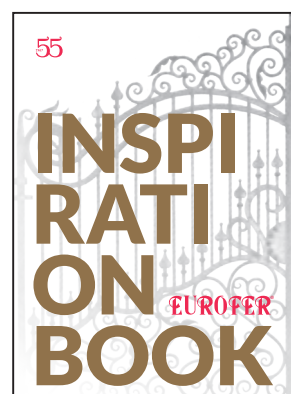

Art. 5100
Inspiration Book

NEW

LASERFFER

BY EUROFER

Contiene la gamma rinnovata della linea Laserfer.
Includes the updated range of the Laserfer line.



*Hommage à la Tour Eiffel en or.
Eurofer dédie son catalogue au monument
en fer le plus célèbre au monde.*

*Omaggio alla Tour Eiffel in oro.
Eurofer dedica il proprio catalogo
al monumento in ferro più celebre al mondo.*

*Homage to the Eiffel Tower painted in gold.
Eurofer dedicates its catalogue to the most
famous iron monument in the world.*

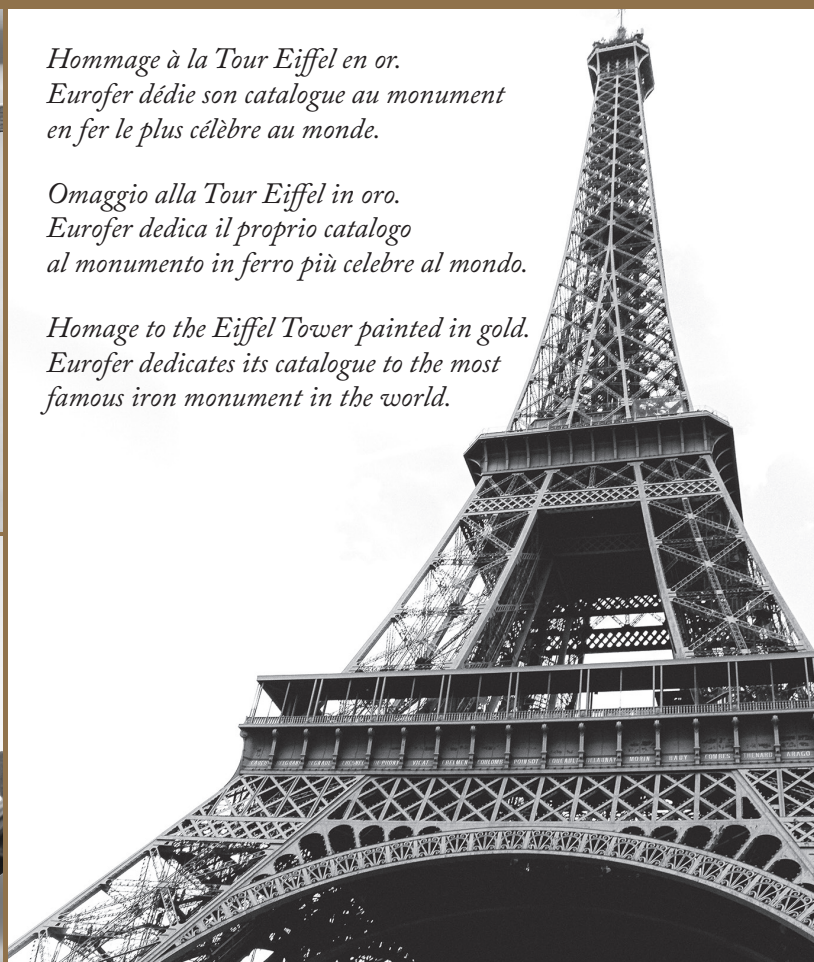

EURO-FER S.p.A.

Viale dell'Industria 16/18
Castelgomberto (Vicenza)
Telefono: +39 0445 440033
FAX: +39 0445 440351
E-mail: eurofer@eurofer.com

www.eurofer.com

